

# Breezair EXQ210 Owner's Manual

[Shop genuine replacement parts for Breezair EXQ210](#)

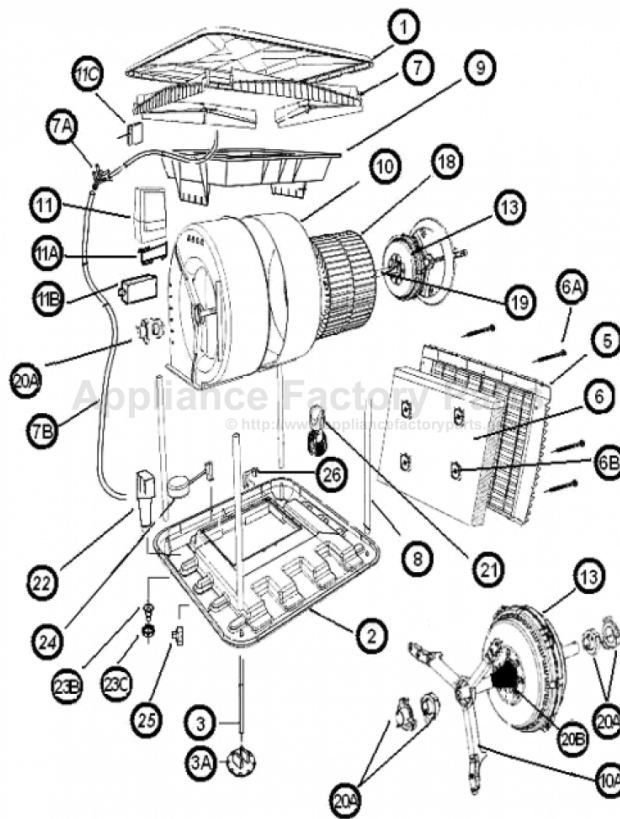

[Find Your Breezair Evaporative Cooler Parts - Select From 59 Models](#)

----- Manual continues below -----

# OWNER'S MANUAL

EXQ / EZQ / EXS Evaporative Coolers

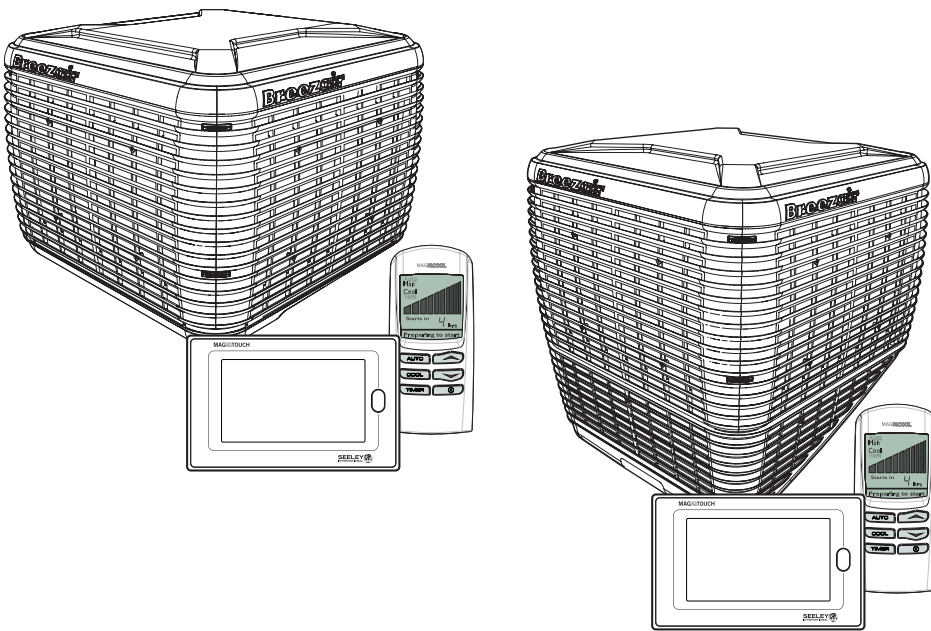

(English)

## **IMPORTANT SAFETY INSTRUCTIONS**

**READ AND SAVE THESE INSTRUCTIONS FOR FUTURE REFERENCE.**

**WARNING - TO REDUCE THE RISK OF FIRE, ELECTRIC SHOCK, OR INJURY TO PERSONS, OBSERVE THE FOLLOWING:**

a) Use this unit only in a manner intended by the manufacturer. If you have questions, contact the manufacturer.

b) Before servicing or cleaning unit, switch power off at service panel and lock the service disconnecting means to prevent power from being switched on accidentally. When the service disconnecting means cannot be locked, securely fasten a prominent warning device, such as a tag, to the service panel.

This cooler is fitted with a MagIQtouch or MagIQcool Controller. Please refer to the separate manual provided with the MagIQtouch Controller for instructions on how to set-up and operate this system. For the MagIQcool Controller, you'll find details on set-up and operation in this manual.

### **FOR EUROPE**

This appliance can be used by children aged from 8 years and above and persons with reduced physical, sensory or mental capabilities or lack of experience and knowledge if they have been given supervision or instruction concerning use of the appliance in a safe way and understand the hazards involved. Children shall not play with the appliance. Cleaning and user maintenance shall not be made by children without supervision.

### **FOR AUSTRALIA, NEW ZEALAND & OTHER NON-EUROPEAN COUNTRIES**

This appliance is not intended for use by persons (including children) with reduced physical, sensory or mental capabilities, or lack of experience and knowledge, unless they have been given supervision or instruction concerning use of the appliance by a person responsible for their safety. Children should be supervised to ensure that they do not play with the appliance.

## IMPORTANT NOTES!

In areas where temperatures can cause water supply pipes to freeze, a drain down facility should be provided during the installation. This drain down facility must be activated prior to freezing conditions, to avoid possible damage to the cooler components.

If the supply cord is damaged, it must be replaced by a Seeley service agent or similarly qualified person in order to avoid a hazard.

New hose sets supplied with the appliance are to be used.

Old hose sets (from previous installations) should not be re-used.

Details on how to register your product warranty can be found near the end of this Owner's Manual.

As with any product that has moving parts or is subject to wear and tear, it is **VERY IMPORTANT** that you maintain the product and have it regularly serviced. It is a condition of warranty cover for your product that you comply with all of the maintenance and service requirements set out in the Owner's Manual. Compliance with these requirements will prolong the life of your product.

Further, it is also a condition of warranty cover that each item in the Maintenance Schedule in the Owner's Manual is performed with the frequency indicated, by a qualified, licensed technician, and that the Maintenance Schedule is properly filled out (ie names, signature, date, and action taken) when the item is completed.

**ANY FAILURE TO CARRY OUT THE REQUIRED MAINTENANCE AND SERVICING REQUIREMENTS, AND ANY FAILURE TO PROPERLY FILL OUT THE MAINTENANCE SCHEDULE, WILL VOID YOUR WARRANTY.**

## TABLE OF CONTENTS

<b>OPERATING YOUR COOLER</b>	<b>1</b>
<b>MAGIQTOUCH CONTROLLER OPERATION</b>	<b>1</b>
<b>MAGIQTOUCH CONTROLLER® SETTINGS MENU</b>	<b>1</b>
About Appliance	1
Min/Max Set Temperature	1
Night Quiet Mode	1
Manual Drain	1
Pad Flush	1
Drain and Dry	1
AutoClean	1
External Sensor	1
<b>MAGIQCOOL CONTROLLER SETTINGS</b>	<b>2</b>
Manual mode	2
Auto mode	2
<b>MAGIQCOOL CONTROLLER OPERATION</b>	<b>2</b>
Turning the cooler on	2
Preparing to start	2
Manual mode	2
Auto mode	3
Delayed stop or start	3
Programming in Manual mode	3
Programming in Auto mode	4
Service mode	4
Drain mode (Cooler switched off)	5
<b>WATER MANAGEMENT</b>	<b>6</b>
<b>WATERMISER®</b>	<b>6</b>
<b>DRAIN VALVE</b>	<b>6</b>
<b>BLEED SYSTEM</b>	<b>6</b>
<b>POWER OUTAGES</b>	<b>6</b>
<b>HEALTH REGULATIONS</b>	<b>6</b>
<b>MAINTENANCE</b>	<b>7</b>
<b>SEASONAL MAINTENANCE</b>	<b>7</b>
Pre-Season	7
End of Season	7
<b>REMOVING PAD FRAMES</b>	<b>8</b>
<b>PAD FRAME POSITIONS</b>	<b>8</b>
<b>MAINTENANCE SCHEDULE</b>	<b>9</b>
<b>TROUBLESHOOTING</b>	<b>10</b>
<b>HOW TO REGISTER YOUR PRODUCT WARRANTY (Australia only)</b>	<b>11</b>
<b>WARRANTY TERMS AND INFORMATION (Australia only)</b>	<b>12</b>

## Hello and congratulations on purchasing a Seeley evaporative cooler

At Seeley International we manufacture Breezair® evaporative coolers from the highest quality materials, and we have designed the product to provide many years of economical, trouble-free cooling.

### OPERATING YOUR COOLER

To provide efficient cooling or ventilation the building must have sufficient exhaust openings to the outside of the building. To assist air flow, open windows and doors that are farthest from the outlet vent in each room. In these rooms, provide an exhaust opening about 2 times the vent size of the room.

Where the design of the building prevents adequate exhaust, consideration should be given to the provision of mechanical extractions, such as an exhaust fan.

There are three main ways that an evaporative cooler can operate to provide cooling comfort.

- The cooler can be set at a constant fan speed, without reference to the current temperature.
- The cooler can be given a temperature target, in which case it will vary the fan speed in order to get as close to the target as possible. (**Note!** Humid weather conditions may limit what temperatures can be achieved.)
- The cooler can be set to a fan only mode, providing air circulation only.

### MAGIQTOUCH CONTROLLER OPERATION



Refer to the Owner's Manual supplied with the controller for operating instructions.

### MAGIQTOUCH CONTROLLER® SETTINGS MENU

Your MagiQtouch Controller contains a settings menu which gives you access to information about your Breezair® evaporative cooler and to extra functions including:

#### About Appliance

Access information about the appliances installed in your system.

#### Min/Max Set Temperature

You can change the minimum and maximum temperature displayed on your slider, depending on what temperature range you prefer your system to work within.

#### Night Quiet Mode

Restrict fan speed over the night time period for a quiet night's sleep.

#### Manual Drain

This will turn the cooler off and drain the tank.

#### Pad Flush

This will turn the cooler off and run the pumps for a specified time. Use this feature to flush the cooler pads.

#### Drain and Dry

This option allows you to nominate a time each day when the cooler will drain the tank and run the fan for 1 hour.

#### AutoClean

Select the preferred cleaning interval (50 / 100 / 200 hrs). At 8.00am after the selected running hours has been reached, the cooler will drain the tank, fill with fresh water and operate the pump for 5 minutes. When complete, drains the tank and returns to previous operation mode.

#### External Sensor

EXS models are fitted with an external air sensor. When switched on, it displays a live external ambient temperature reading on the wall controller. A desired external temperature set point can be programmed to turn off the pump conserving water usage and reducing humidity while the cooler is running. In addition where climate conditions are close to freezing, an external temperature set point can be programmed to auto drain the tank and prevent freezing conditions damaging the tank.

**Note!** There are some settings, which are locked and are only for installers or service technicians.

## MAGIQCOOL CONTROLLER SETTINGS

MagIQcool Wall Controllers can operate in manual or automatic mode.

### Manual mode

Manual mode will allow you to change settings for operating the cooler, such as altering fan speeds, pump control and manual drain control.

### Auto mode

Auto mode will allow thermostatic control to set temperature targets / operating settings. It has the capability of programming ON/OFF delay times, enabling the cooler to automatically start up or shut down after a specified period of hours.

At all times the MagIQcool Controller will monitor the cooler for faults and report them to the controller's screen for your reference.



## MAGIQCOOL CONTROLLER OPERATION



ILL2121-A

### Turning the Cooler On

The wall control can be switched on and off by pressing the  button. The wall control will remember the previous setting it was in when the cooler was last used.

### Preparing to Start

Whenever you select AUTO mode or COOL in MANUAL mode, the cooler will take a few minutes to start as it fills with water and saturates the cooling pads. The time will be decreased if the tank is full or the cooler has only recently been turned OFF.

During this time "Preparing to Start" will flash on the display.

### Manual Mode

With the wall control switched ON, press the  button until MAN is shown on the display.

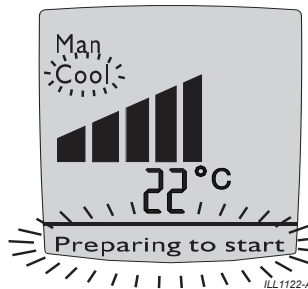



ILL1122-A

## MAGIQCOOL CONTROLLER OPERATION CONT

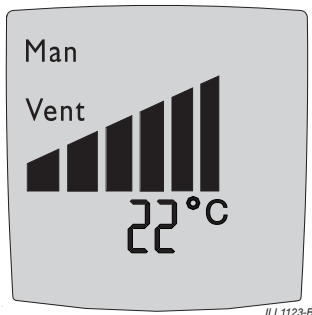
You may then press the  button to switch between COOL and VENT (where fresh air is being delivered but not cooled).





Once COOL or VENT has been selected, the wall control will maintain a constant fan speed. This is indicated by the bar graph shown on the display.

To increase or decrease the fan speed required, press either the  or  button.

### Auto Mode

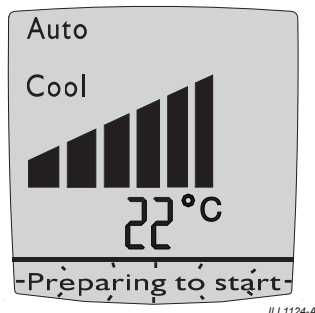
To select the AUTO mode press the  button until AUTO is shown on the display.



In AUTO mode the cooler will remember the last setting used. Press the  button if you require more cool air or the  button if you require less. Don't alter the setting however, until the room temperature has stabilised.





## MAGIQCOOL CONTROLLER OPERATION CONT

### Delayed Start or Stop

The cooler can be programmed to start at a specific time or stop at a specific time.

The delayed start time can only be programmed when the cooler is OFF. To program the cooler to start in a certain amount of hours use the following sequence:

### Programming In Manual Mode

- (1)..... Press the  button.
- (2)..... Press the  button until MAN is displayed on the screen.
- (3)..... Press the  or  button until the desired fan speed is displayed by the bars in the middle of the screen.

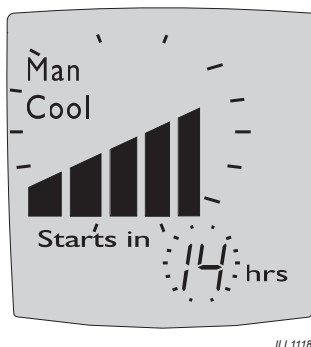

- (4)..... Press the  button to set either COOL or VENT.







- (5)..... Press the  button and the 'starts in' time will start flashing.

Use the  and  buttons to select the desired time.

- (6)..... Press  again.

# MAGIQCOOL CONTROLLER OPERATION CONT.



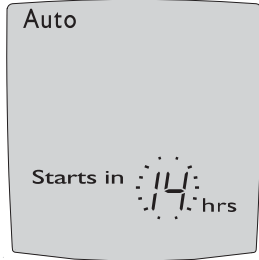

## Programming In Auto Mode

- (1)..... Press the  button.
  - (2)..... Press the  button until AUTO is displayed.
  - (3)..... Press the  button and the "Starts in" time will start flashing.
- Use the  or  button to select the hour.
- (4)..... Press  again.



ILL1117-B

The delayed stop time can only be programmed once the cooler is ON. This is ideal if you are going to bed but don't want to turn the cooler off straight away. To program the delayed time in which you want the cooler to stop use the following sequence:

- (1).....Select the  button and the "Stops in" time will start flashing.
- Use the  and  buttons to select the desired off time.
- (2).....Press  again.

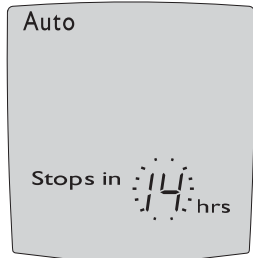

ILL1119-B

## Service Mode

When a fault has been recognised by the wall control the word "Service" flashes on the screen.



ILL1120-B

When "Service" is displayed it may be necessary for you to phone the service number located near the back of this manual. However, before doing so, turn the wall control OFF. You will notice a number flashing at the bottom of the screen. This number indicates the reason for requiring service.

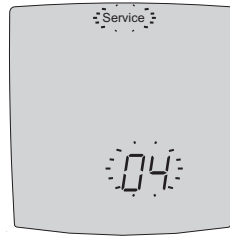

ILL1121-B

Please write this number down, then push the  button to turn the cooler back on. If after a short time "Service" is again shown on the display, turn the wall control OFF and check if the flashing number is the same. If it is the same check for the following possible problems.

However, we do recommend that any checks be carried out by an authorised dealer or service agent.

## MAGIQCOOL CONTROLLER OPERATION CONT.

If '02' is displayed

(1).....Check that the water supply tap to the cooler is turned on.



(2).....Check that your local water authority haven't temporarily disconnected the water in your area.

If '04' is displayed

(1).....If your cooler is fitted with a drain valve, check that the drain is not blocked.

If these do not fix the problem then contact your dealer or the service number near the back of this manual. You will need to quote the flashing number that you wrote down.

### Drain Mode (Cooler switched OFF)

Pressing the  and  buttons at the same time for 2 seconds will open the drain valve and empty the water in the tank. The wall control will display "dr" on the screen. Draining the water will leave the tank clean and dry until it is next used.

## WATER MANAGEMENT

Your evaporative cooler will be fitted with either a WaterMiser® system, or a continuous bleed system. Check with your dealer to determine which system has been installed.

### WATERMISER®

Breezair® evaporative coolers are fitted with the WaterMiser® feature which automatically monitors the quality of the water in the cooler.

The WaterMiser® drains the existing water in the cooler to allow it to be replaced with fresh water, only when it is needed. Therefore, you may notice your cooler draining water occasionally. How often the WaterMiser® performs this operation depends upon the quality of the water supply and the rate of evaporation. In areas of poor water quality, the WaterMiser® will operate more often as it tries to maintain the optimum water quality in the cooler. This maximises the cooling effect and life of the cooling pads.

The WaterMiser® allows you to specify either high or low salinity settings. The low salinity setting is used in specific circumstances only. We recommend talking with your dealer before adjusting this setting.

The high salinity setting is designed to operate the cooler at a maximum safe salinity level to maintain a normal working life. It also results in a minimum usage of water.

**Note!** High salinity outlet water can be used on saline tolerant gardens, but should not be used on salt sensitive grasses or plants.

The factory default WaterMiser® setting is HI. For areas operating with bore water, WaterMiser® should be switched to off. This will disable the salinity measuring circuit and simply drain water from the tank every 65 minutes of operation.

### DRAIN VALVE

If your cooler has been installed with a drain valve, it is accompanied by the WaterMiser® salinity probes. When the tank's water salinity level reaches a preset level the WaterMiser® will

open the drain valve and release saline water. Fresh water will then be added diluting any minerals or salts accumulated. The WaterMiser® will continue to monitor and drain water as required.

Alternatively, the cooler can be set to drain saline water at a preset period of pump operating time. This can be set by changing the salinity control method selector via the cooler settings screens.

**Note!** When the cooler's tank is empty and the cooler is turned on again, the fan operation will be delayed as the tank is refilled and the pads are saturated.

### BLEED SYSTEM

If fitted, the bleed system will constantly drain small amounts of water during the operation of the cooler. This allows fresh water to be added diluting any minerals and salts accumulated.

The bleed rate for your cooler will depend on local operating conditions and will be set by the installer.

### POWER OUTAGES

After a power outage the MagIQtouch Controller will prompt you to enter the date and time.

If the AUTO RESTART option is switched on in the SETTINGS menu, the following actions will result:

- If the cooler was last running in MANUAL mode, it will automatically restart only after the date and time have been confirmed.
- If the cooler was last running in PROGRAM mode, it will automatically restart, even before the time and date have been set, according to the last time recorded before the power outage.

### HEALTH REGULATIONS

In some regions, regulations require that evaporative air coolers be serviced at specific intervals.

## MAINTENANCE

**WARNING! As your cooler is mounted on the roof, we suggest that any maintenance or checks be carried out by an authorised Seeley International dealer or service agent. Climbing onto the roof can be hazardous and could result in injury to you and damage to your property.**

For gaining access to the cooler refer to the Removing Pad Frames section.

Maintenance Schedule servicing is essential to ensure the cooler operates efficiently for many years. It must be carried out by a qualified, licensed technician. The following pages outline the suitable maintenance requirements to ensure that your cooler continues to operate efficiently.

We require that the following components and the operation thereof, be checked/ serviced after the first year, then every 2 years for residential purposes, or every year for commercial purposes, as Maintenance Schedule servicing. Refer to the Maintenance Schedule section.

- Water distribution spreader trays.
- Pump.
- Drain valve.
- Solenoid and associated filter / fittings.
- Fan motor operation.
- Float valve.
- Salinity probes etc

Maintenance Schedule servicing should be performed before the summer season. It is important to note that all evaporative coolers have components that may need periodic replacement (eg. filter pads, hoses, o-rings etc).

**Note!** Failure to carry out the Maintenance Schedule services will void your warranty cover.

**Note!** Maintenance Schedule servicing may be required more frequently in adverse environmental situations or where the appliance is installed in non-domestic applications. Please consult with the installer or service personnel to determine if more frequent servicing is required.

## SEASONAL MAINTENANCE

Seasonal Maintenance is only required if you have a cooler fitted with a bleed system. If your cooler is fitted with a drain valve, no Seasonal Maintenance is required.

Seasonal Maintenance services must be performed before and after the summer season.

### Pre-Season

1. Remove the pad frames as shown on the next page.
2. Ensure the power is off at the isolating switch inside the cooler.
3. Gently wash the pad frames to remove any dust build up during the winter.  
**Note!** Do not wash the pads with high pressure water spray. If the pads are salted-up, replace them.
4. Check for water leaks. Check operation of the float valve.
5. Turn on the water supply to the cooler.
6. Switch on the isolating switch.
7. Refit the pad frames.
8. Run the cooler.

**WARNING!** Ensure the pad frames are fitted when operating the cooler.

### End of Season

1. Turn off the water supply to the cooler.
2. Remove the pad frames
3. Turn off the power at the isolating switch inside the cooler.
4. Check and clean the water distributing spreader tray channels under the lid.
5. Drain the tank.
6. Thoroughly clean the tank, pump filter and salinity probe (if fitted).
7. If a drain valve is fitted it will automatically drain. If a bleed funnel is fitted, remove it from the tank as shown below. Keep the O'Ring in a safe place for later use.

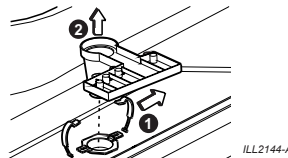

8. Refit the pad frames.

## REMOVING PAD FRAMES

### To remove a pad frame:

1. Remove the clips holding the pad frame in place.
2. Insert a flat head screw driver into the slot between the lid and the top of the pad frame. Lever it so the pad frame is released.
3. Take hold of the pad frame, pivot it outwards and lift it up. Be careful not to damage the pad.

EXQ / EXS

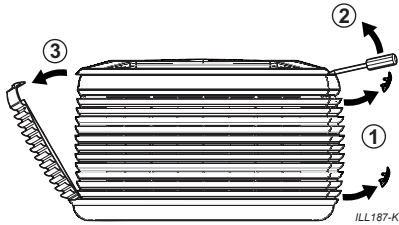

EZQ

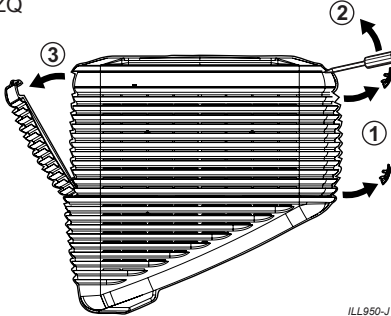

## PAD FRAME POSITIONS

When re-fitting pads, ensure that they are fitted in their original positions. EXQ210, EZQ215 and all EXS model coolers have pads that vary from the standard 90mm thickness. While removing the pad frames, take note of the location each belongs to.

**Check for stickers indicating correct locations for thick or cut edge pads.**

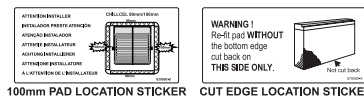
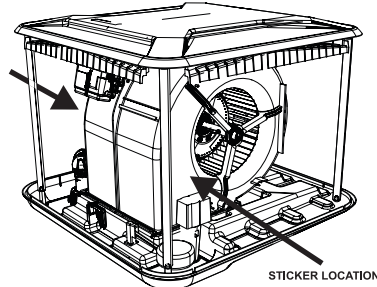

Stickers adhered to the fan scroll indicate the correct position.

**If fitted incorrectly they may cause problems:**

- Thicker pads may catch on internal components causing damage.
- Thicker pads may impede the correct operation of the float valve.
- Incorrect positioning of pads may cause a drop in cooler performance.
- Incorrect fitment may allow water to bypass the pad and be carried over into the air stream and ducting.
- Water bypass may cause damage to internal electronic components.

# MAINTENANCE SCHEDULE

Service Item	Check/Adjust					Clean					Replace				
	1	2	3	4	5	1	2	3	4	5	1	2	3	4	5
<b>Water Distribution System</b>															
Chillcel Pads (replace as required)															
Pad Retaining Washers/Pins															
Tank/Water Reservoir															
Pump Filter															
Water Probes															
System Washers, Seals and O'Rings (replace as required)															
Drain Valve/Bleed Funnel operation															
<b>Component Function</b>															
Pump operation															
Drain Valve operation															
Motor Operation															
Solenoid operation															
Wall Control operation															
<b>General Operation</b>															
Water Level Set Point															
Water Fill Time															
Water Drain Time															
Water Distribution across Pads															
Airflow through system/Outlets															
General Product condition (includes correct fitting of all components and items - replace as required)															

Service No.	Service Date	Service Technician	Service Company
No.1	.....	.....	.....
No.2	.....	.....	.....
No.3	.....	.....	.....
No.4	.....	.....	.....
No.5	.....	.....	.....

## TROUBLESHOOTING

Symptom	Cause	Action
Unpleasant odour	Odour from the new pads	<ul style="list-style-type: none"> <li>Use the 'Pad Flush' function in the SETTINGS menu of your Controller to flush pads.</li> <li>Fill tank, run pump for a short period to wash pads, drain tank, refill and repeat several times if odour persists. Odour will dissipate after a number of hours of operation.</li> </ul>
Inadequate cooling	Dry pads	Ensure the water supply is turned on. Then check the water flow to the pads.
	Insufficient exhaust openings for conditioned air	Ensure sufficient exhaust openings.
	Excessive ambient humidity	On days during the summer when the ambient humidity is high, the cooler will not reduce the temperature as much as on drier days.
Cooler turns ON and OFF	Fault in the cooler	Contact your Seeley International authorised dealer or service number.

If your controller prompts you to call a service agent, please contact your local Seeley International authorised dealer or the service number on the back of this manual.

**Important!** In an emergency we recommend that you immediately cease operating the appliance, and if applicable, have the power and water isolated.

# HOW TO REGISTER YOUR PRODUCT WARRANTY (AUSTRALIA ONLY)

## Warranty Information section

### HOW TO REGISTER YOUR PRODUCT WARRANTY (Australia only)

Please register your warranty online by visiting [www.seeleyinternational.com](http://www.seeleyinternational.com) and following these steps:

**Step 1** Select "GET SUPPORT" and "REGISTER A WARRANTY"

**Step 2** Select the brand of the product you purchased

**Step 3** Enter the required information and "Submit"

(Alternatively, if you have a smart phone or tablet, using an app you can scan the QR code on the back of the manual provided with the cooler, which will take you directly to the webpage for product warranty registration.)

Important Note: You need to have the following information to complete your registration:

- your unit model and size
- serial number
- date your system was installed
- name of the dealer you purchased it from

Please complete this section. You will also need to retain your purchase receipt, and proof of any warranty period extension.

Brand: \_\_\_\_\_

Model: \_\_\_\_\_

Serial No: \_\_\_\_\_

Customer Name: \_\_\_\_\_

Installation Address: \_\_\_\_\_

Installation Type: Residential / Non Residential / Commercial

Date of installation: \_\_\_\_\_

Installer / Dealer: \_\_\_\_\_

# WARRANTY TERMS AND INFORMATION (AUSTRALIA ONLY)

## Warranty Details (Australia only)

In this warranty:

**We or us** means Seeley International Pty Ltd (Seeley) ABN 23 054 687 035, and our contact details are set out at the end of this warranty;

**You** means you, the original end-user purchaser of the Goods;

**Supplier** means the authorised distributor or retailer of the Goods that sold you the Goods in Australia;

**Goods** means the product, unit, appliance or equipment which was accompanied by this warranty and purchased in Australia; and

**Relevant Warranty Period** means the various warranty periods as described in clause 1 and clause 3 below, as appropriate.

Our Goods come with guarantees that cannot be excluded under the Australian Consumer Law. You are entitled to a replacement or refund for a major failure and for compensation for any other reasonably foreseeable loss or damage. You are also entitled to have the Goods repaired or replaced if the Goods fail to be of acceptable quality and the failure does not amount to a major failure.

In addition to any rights and remedies that You may have under the Australian Consumer Law or any other law, subject to the terms of this warranty, We provide the following warranty:

1.
  - a. Subject to clause b. below, if during the first five (5) years from the date of purchase when the Goods are used for personal, residential household purposes, and for two (2) years for any other purpose the Goods upon examination prove defective by reason of improper workmanship or material, We will repair or replace, at our option, the Goods or any part thereof without charge for either parts or labour, during normal working hours.
  - b. For Braemar EA Model evaporative coolers, the warranty periods in clause a. above shall be as follows:
    - Braemar EA variable/two speed: the first mentioned period shall also be five (5) years. The second mentioned period shall also be two (2) years, but only if the Goods are used for a commercial purpose.
    - Braemar EA Plug Connect: the warranty period shall be two (2) years, regardless of whether the Goods are used for personal, residential household purposes or any other purpose, however the warranty shall only cover the cost of parts, not labour or any other charge.
2. The warranty granted under clause 1 applies to all components which form part of the original evaporative air cooler, but does not cover:
  - a. fair or normal wear and tear;
  - b. damage, loss or claims caused by, resulting from, or arising out of any utilities that service or are connected to the Goods, electrical surges, inadequacies, failure, or other problems in or with any electricity, power, water, or gas supply to the Goods;
  - c. after the first year: (i) the replacement, supply, or servicing of consumable items (including without limitation cooler pads, washers, seals, drive belts) and (ii) maintenance adjustments to the evaporative air cooler; and
  - d. installation (including without limitation ductwork, fittings, return air filters and other related installation components) which is excluded.
3. Seeley also warrants the structural integrity of all components made from our exclusive Permatuf polymers for ten (10) years and your evaporative air cooler cabinet (base, top, corner supports, side panels, fan and fan housing) against damage caused to it by all forms of corrosion for twenty five (25) years.
4. During the period to which any expressed warranty applies, all defective part(s) shall be replaced or repaired (at the discretion of Seeley) without charge for either parts or labour, during normal working hours. Should we deem in our absolute discretion to replace the Goods pursuant to clause 1 or clause 3, we may substitute any similar good even if it is not on our current price/equipment list. Further, Goods presented for repair may be replaced by refurbished goods of the same type rather than being repaired. Refurbished parts may be used to repair the Goods.

## WARRANTY TERMS AND INFORMATION (AUSTRALIA ONLY) CONT.

5. We are under no obligation to repair or replace the Goods or Parts under clause 1 and 3 above if (i) the Goods have not been installed and commissioned in accordance with the Installation Manual (ii) the Goods have not been installed and commissioned properly or competently, (iii) the Goods have not been operated, serviced and maintained in accordance with the instructions provided in the Owner's Manual, or (iv) if any such service or maintenance has not been properly or competently performed. It is a condition of warranty cover that each item in the Maintenance Schedule in the Owner's Manual (if it was published with such a Schedule) is performed with the frequency indicated, by a qualified, licensed technician, and that the Maintenance Schedule is properly filled out (ie names, signature, date, and action taken) when the item is completed. Any failure to carry out the required maintenance and servicing requirements, and any failure to properly fill out a Maintenance Schedule in the Owner's Manual, will void your warranty. The addition of any third party device, (except where it is required by the installation instructions and complies with those instructions), or the removal or alteration of any Seeley component, or damage due to misuse of the unit, or faulty installation or commissioning, will void this warranty.
6. As far as the law permits, We will not be liable for any consequential loss suffered through, or resulting from, the non-operation, or ineffective operation of the evaporative air cooler. The warranties granted under clause 1 and clause 3 do not cover damage to the evaporative air cooler or other loss resulting from acts of God.
7. No other person, company or corporation is authorised to offer, or give on our behalf, any other warranty. The benefits conferred are in favour of You and any person deriving title to the evaporative air cooler whilst in its original place of installation. Nothing in this warranty shall be construed as affecting any rights You may have under all the relevant laws, or Commonwealth or State Legislation which give You rights which cannot be modified or excluded by agreement.
8. In order to claim under the warranties granted under clause 1 or clause 3 You must:
  - a. either:
    - contact us within the Relevant Warranty Period on 1300 650 644; or
    - log a warranty claim on our website (website address below) within the Relevant Warranty Period; and
  - b. make available for inspection by the service agent who will come to the location of the Goods or send to us at the address below within the Relevant Warranty Period: (i) the legible and unmodified original proof of purchase, which clearly indicates the name and address of the original retailer, the date and place of purchase, the product name or other product serial number, (ii) all of your records of all service and maintenance carried out to the Goods, plus the Maintenance Schedule in the Owner's Manual (if it was published with such a Schedule), (iii) a copy of the completed Warranty Information section above, and (iv) if an extended warranty period was provided by Seeley International for the Goods, then the relevant document provided by Seeley International confirming that extended warranty period. If you choose to send the documents described in (i) to (iv) to Seeley International, then they must be accompanied by a covering letter which states your name and address and daytime telephone number, the address at which the Goods are installed, and the model and serial number of the Goods.
9. The warranty granted in clause 1 and clause 3 covers the costs of parts and labour (note that under clause 1 for Braemar EA Plug Connect models only parts are covered, not labour) but you will be responsible for:
  - a. the cost of travel incurred for a Seeley International service agent to get to and from the location of the Goods if the location of the Goods is either: (i) outside the metropolitan areas of the capital cities; or (ii) more than 35 kilometres from an authorised Seeley International branch or service representative; and
  - b. any costs for additional labour or equipment associated with gaining acceptable and safe service access to the Goods installed in restricted, high or unsafe locations, and/ or the removal and replacement of any barrier, walls, roofs, fences etc; and
  - c. any costs incurred by the Seeley International service agent in gaining access to the Goods which is necessary to comply with any safety or workplace safety requirements and/or any other relevant regulations. For the avoidance of doubt, the reference to any costs incurred also includes the cost of any necessary site inductions.
10. Seeley International is not responsible in any way for any failure and/or inadequate performance of the Goods which arises from or is connected to the use in the Goods of non-genuine spare parts. Seeley International strongly recommends that only spare parts supplied or approved by it are used in the Goods.

## WARRANTY TERMS AND INFORMATION (AUSTRALIA ONLY) CONT.

11. The employees and Executive of Seeley International are not responsible for the installation of the Goods and expressly disclaim all liability resulting from incorrect installations or installations that do not conform to local electrical codes, local plumbing codes, Occupational Health and Safety requirements, and by laws which are legislated or in effect at the time of installation.

12. This warranty is only valid and enforceable in Australia.

Note: Seeley and its service agents reserve the right to refuse service unless safety and accessibility to the unit can be guaranteed. If a service call reveals no warranty fault found with the Goods, a charge will be made for the call.

Our liability under this warranty is limited to the extent permitted by law. That is, to the extent that it is fair and reasonable, if the Goods are not of a kind ordinarily acquired for personal, domestic or household use or consumption, your remedies associated with any failure or defect of the Product will be limited to:

- a. the replacement of the Goods or the supply of equivalent goods;
- b. the repair of the Goods;
- c. the payment of the cost of replacing the Goods or of acquiring equivalent goods; or
- d. the payment of the cost of having the Goods repaired

and subject to the terms and conditions included in this warranty.

Service Department

Seeley International Pty Ltd

112 O'Sullivan Beach Road

Lonsdale, South Australia 5160

Customer service centre 1300 650 644

Website: [www.seeleyinternational.com](http://www.seeleyinternational.com)

### FOR SERVICE

#### Service call Booking

To book a Service on your Seeley International product Online visit [www.seeleyinternational.com](http://www.seeleyinternational.com)

**Step 1** Select "GET SUPPORT" and "REQUEST A SERVICE BOOKING"

**Step 2** Click on "SERVICE REQUEST"

**Step 3** Select the brand of the product you require a service on and follow the prompts, or Phone 1300 650 644 to be directed to your closest authorised Service Agent

### PRIVACY NOTICE

Seeley International Pty Ltd ABN 23 054 687 035 will use the personal information you provide us with to provide warranty support for the product you have purchased and to inform you about other products and services. If you choose not to supply us with the information requested, we may be unable to provide you with warranty support. We may also disclose your information to third parties, such as related entities; retailers, distributors, service agents and contractors who are affiliated with us; or marketing or market research companies. If you would prefer not to receive direct marketing communications from us, please follow the instructions to "unsubscribe" which will be included in the direct marketing communications we send you, or contact our Privacy Officer using the details set out below. While we do not currently transfer personal information to overseas recipients or store personal information overseas, if we transfer your information to third parties who do so, we will take reasonable steps to ensure that the overseas recipients do not breach the *Australian Privacy Principles*. By registering your warranty, you consent to having your personal information used in this way. Please read our Privacy Policy on our website [www.seeleyinternational.com](http://www.seeleyinternational.com) for further explanation of how we collect, use, hold and disclose personal information, and how you may access and seek correction of your information. It also sets out how you may complain about a breach of the Australian Privacy Principles, and how we will deal with your complaint. You may contact us at: Privacy Officer, Seeley International Pty Ltd, 112 O'Sullivan Beach Road, Lonsdale, South Australia 5160.



**When your product requires servicing, please  
quote the cooler serial and model number**

Affix serial & model  
numbers sticker here



**Service**

For Australia contact 1-300-650-644  
For outside Australia contact your local dealer  
[seeleyinternational.com](http://seeleyinternational.com)

**MANUFACTURED BY: SEELEY INTERNATIONAL PTY LTD**  
*112 O'SULLIVAN BEACH RD, LONSDALE SA, 5160. AUSTRALIA*

**IMPORTED BY: SEELEY INTERNATIONAL (EUROPE) LTD**  
*UNIT 11 BYRON BUSINESS CENTRE DUKE STREET,  
HUCKNALL NOTTINGHAM, NG15 7HP UNITED KINGDOM*

**SEELEY INTERNATIONAL (AMERICAS) LTD**  
*1002 S 56TH AVENUE, SUITE # 101  
PHOENIX, ARIZONA 85043, USA*

**SEELEY INTERNATIONAL (AFRICA) PTY LTD**  
*6 WITTON ROAD, FOUNDERSVIEW SOUTH,  
MODDERFONTEIN 1609, GAUTENG, SOUTH AFRICA*

It is the policy of Seeley International to introduce continual product improvement.  
Accordingly, specifications are subject to change without notice.  
Please consult with your dealer to confirm the specifications of the model selected.



864688-B

[seeleyinternational.com](http://seeleyinternational.com)

AU EU US 1607