

Breadman®

**INSTRUCTION
MANUAL**



AUTOMATIC BREAD BAKER

T.R. 442



TABLE OF CONTENTS

Important Safeguards	1
Your Breadman® Bread Baker	2
Control Panel	3
<hr/>	
Using the Breadman®	4 - 5
Kneading and Baking Cycles	6
Making Dough and Baking Bread	7 - 11
Using the Timer	12 - 13
Cleaning Instructions	14
Trouble Shooting	15 - 17
Notes	18 - 20
Warranty	21



IMPORTANT SAFEGUARDS

When using the Breadman® Automatic Bread Baker, basic safety precautions should always be followed, particularly the following:

1. **READ ALL INSTRUCTIONS BEFORE USE.**
2. Do not touch hot surfaces. Use handles or knobs. Always use oven mitts when handling hot materials and allow metal parts to cool before cleaning.
3. Unplug this product from wall outlet when not in use and before cleaning. Allow to cool thoroughly before putting on or taking off parts.
4. Do not immerse appliance in water or any other liquid.
5. Close supervision is always necessary when this or any appliance is used by or near children.
6. Do not allow anything to rest on the power cord. Do not plug in cord where persons may walk or trip on it.
7. Do not operate this or any appliance with a frayed or damaged cord, or after the appliance malfunctions, or has been damaged in any manner. Return the appliance to Salton/MAXIM Housewares, Inc. Repair Dept. for examination and repair.
8. Avoid contact with any moving parts.
9. Do not use attachments not recommended by Salton/MAXIM Housewares, Inc.; they may damage the appliance or cause injury.
10. This appliance is intended for household use only. Do not use outdoors or for commercial purposes

11. Do not let the cord hang over the edge of a table or counter, or touch hot surfaces. Do not place on an unsteady or cloth-covered surface.
12. Do not place the appliance near a hot gas or electric burner, in a heated oven or in a microwave.
13. Keep the unit at least 2 inches away from walls or any other objects when using it.
14. To disconnect, grip the plug and pull the plug from the wall outlet. Never pull on the cord.

SAVE THESE INSTRUCTIONS

Note:

- A. A short power-supply cord is provided to reduce the risk of becoming entangled in or tripping over a longer cord.
- B. If an extension cord is used:
 - (1) the marked electrical rating of the extension cord should be at least as great as the electrical rating of the appliance, and
 - (2) the cord should be arranged so that it will not drape over the counter top or tabletop where it can be pulled on by children or tripped over unintentionally.

CAUTION: During use, the internal parts of the Breadman® and the area around the Steam Vent are **HOT**. **Keep out of reach of children to avoid possible injury.**

FOR HOUSEHOLD USE ONLY



YOUR BREADMAN®

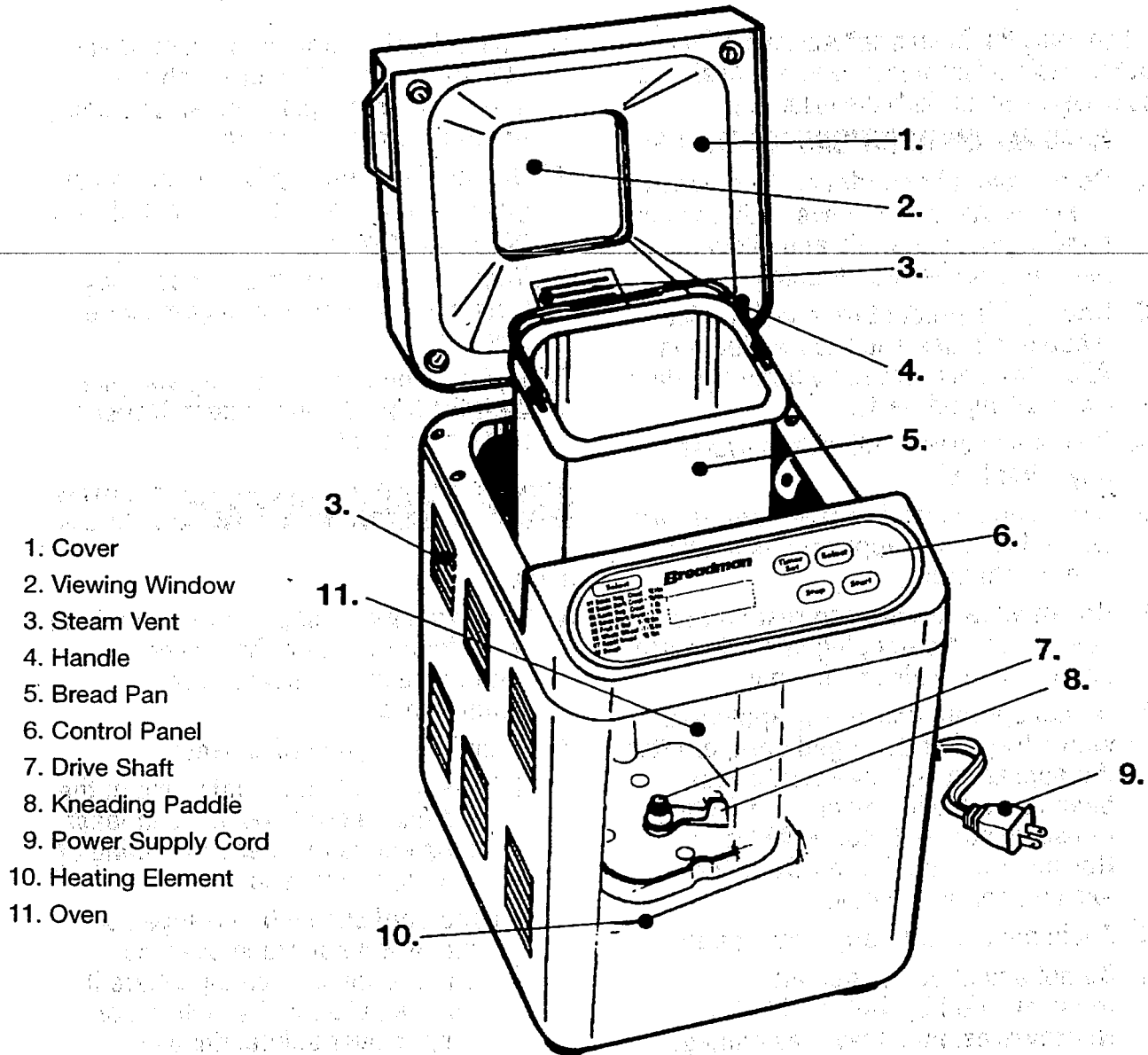

- 1. Cover
- 2. Viewing Window
- 3. Steam Vent
- 4. Handle
- 5. Bread Pan
- 6. Control Panel
- 7. Drive Shaft
- 8. Kneading Paddle
- 9. Power Supply Cord
- 10. Heating Element
- 11. Oven

POLARIZED PLUG

This appliance has a **polarized plug** (one blade is wider than the other). To reduce the risk of electric shock, this plug is intended to fit into a polarized outlet only one way. If the plug does not fit fully in the outlet, reverse the plug. If it still does not fit, contact a qualified electrician. Do not attempt to modify the plug in any way.



CONTROL PANEL

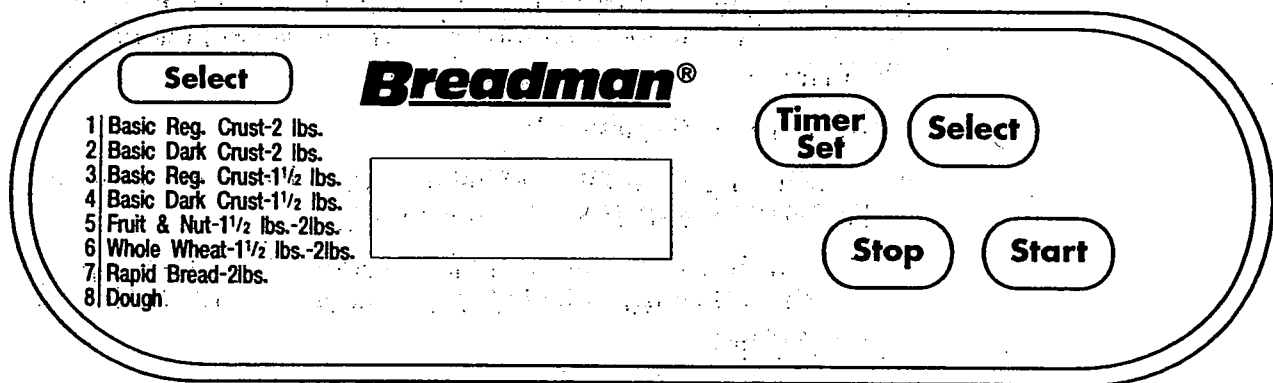

A. Display Window

Shows your selection and Timer setting.

B. Selection Options

Select from these bread choices:

Basic (Regular Crust, 2lbs.)

Basic (Dark Crust, 2lbs)

Basic (Regular Crust, 1-1/2lbs.)

Basic (Dark Crust, 1-1/2lbs.)

Fruit & Nut (1-1/2lbs.-2lbs.)

Whole Wheat (1-1/2lbs.-2lbs.)

Rapid Bread

Dough

C. Timer Set

Use this button to add time displayed in the Display Window.

Each time you press this button, the Timer advances 10 minutes. (*Hint: Hold down the button for speedier results.*)

**See page 12 for detailed instructions.*

D. Select

Press this button to select the Baking cycle you want. Each time you press this button, the selection number appears on the Display Window. Press this button until your choice number shows.

E. Start

Press this button to start the Baking cycle you choose, or to start the Timer.

F. Stop

Press this button for half a second to turn off power, to reset the Baking cycle or Timer setting, or to stop baking.

*When you press the **TIMER**, **SELECT**, **START**, or **STOP** button, you should hear a beep. This lets you know you've pressed hard enough and your selection was made.*



USING THE BREADMAN®

Before using your Breadman® Automatic Bread Baker for the first time, carefully read all of the instructions included in this manual.

With your new Breadman®:

- You can use commonly available pre-packaged bread mixes. Follow the instructions on the package.
- You can bake a loaf of bread from scratch. See the *Recipe and Menu Planner* included with your Breadman® for lots of tasty options.
- You can make dough for rolls or shaped loaves you'll bake in a standard oven. Use the Dough cycle to do the mixing and kneading for you, then shape, proof and bake the bread yourself.

Inserting and Removing the Bread Pan

- To insert the Bread Pan in the Bread Baker, seat it in place with the marking "Lock" facing 6 or 12 o'clock. Then, in a clockwise movement, turn the Pan to 1 or 7 o'clock and it will fit into place.

Remember to insert the Kneading Paddle first, then add all your ingredients BEFORE inserting the Bread Pan into the Oven of your Breadman®.

- To remove the Bread Pan from the Oven, hold the Handle with an oven mitt and lift gently as you turn counter-clockwise until the word "Remove" is at 5 or 11 o'clock.
- When you remove the Bread Pan after baking, BE SURE TO WEAR OVEN MITTS to prevent burning. After you remove the loaf by turning the Bread Pan upside down and shaking gently, check to see that the Kneading Paddle is removed from the loaf. If it is stuck in your bread, use a non-metal utensil to gently remove it, taking care not to scratch the Kneading Paddle.

Operating Tips

- Use oven mitts when working with bread or any part of the Breadman® that is hot from baking.
- Wipe off crumbs and clean the Breadman®, as needed, after baking.
- Unplug the Breadman® when you are not using it.



USING THE BREADMAN® (continued)

Caution

- It is normal for the Viewing Window to collect moisture during the beginning of the Baking cycle. As your bread bakes, the moisture will soon evaporate so you can watch your bread's baking progress.
- Don't open the Lid during Baking. This causes the bread to bake improperly.
- Don't unplug the Breadman® during Kneading or Baking. This will stop the operation.
- To protect young children, keep the Breadman® out of their reach when you're not there to supervise — especially during the Kneading and Baking cycles.
- Use the Breadman® Bread Baker on a flat, hard surface. Don't place it near a flame or heat, or on a soft surface (such as a carpet). Avoid placing it where it may tip over during use. Dropping the Breadman® could cause it to malfunction.
- To avoid burns, stay clear of the Steam Vent during Kneading and Baking. Also, don't touch the Viewing Window — it gets very hot.
- After baking, wait for the Breadman® to cool down before touching or cleaning the Bread Pan or internals of the Breadman® without oven mitts.
- Never use metal utensils with the Breadman® Bread Baker. These can scratch the non-stick surface of the Bread Pan.
- Avoid electric shock by unplugging the unit before using a damp cloth or sponge to wipe the interior of the Oven.
- Never use the Bread Pan on a gas or electric cooktop or on an open flame.
- Avoid covering the Steam Vent during Kneading and Baking cycles. This could cause the Breadman® to warp or discolor.



KNEADING AND BAKING CYCLES

The Breadman® Automatic Bread Baker has various cycles from which to choose:

- The Basic Regular and Basic Dark Baking cycles let you choose your favorite crust for most bread varieties, including whole wheat, rye and white breads.
- Fruit & Nut cycle is for breads such as apple walnut, banana, and raisin bread.

This table shows how long each part of the Baking cycle takes:

SELECTION

BAKING PHASE	Basic Reg. Crust 2 lb.	Basic Dark Crust 2 lb.	Basic Reg. Crust 1-1/2 lb.	Basic Dark Crust 1-1/2 lb.	Fruit & Nut 1-1/2lb.-2lb.	Whole Wheat 1-1/2lb.-2lb.	Rapid Bread 2 lb.	Dough
Rest	4 min.	4 min.	4 min.	4 min.	4 min.	5 min.	—	—
Knead 1	15 min.	15 min.	10 min.	10 min.	15 min.	20 min.	15 min.	15 min.
Rest	28 min.	28 min.	24 min.	24 min.	28 min.	30 min.	12 min.	30 min.
Knead 2	23 min.	23 min.	12 min.	12 min.	23 min.*	25 min.	23 min.	23 min.
Rise	20 min.	20 min.	20 min.	20 min.	20 min.	30 min.	10 min.	20 min.
Punch Down	3 sec.	3 sec.	3 sec.	3 sec.	3 sec.	3 sec.	3 sec.	3 sec.
Final Rise	60 min.	60 min.	60 min.	60 min.	60 min.	60 min.	60 min.	—
Bake	50 min.	50 min.	50 min.	50 min.	50 min.	50 min.	50 min.	—
Hold/Warm	3 hrs.	3 hrs.	3 hrs.	3 hrs.	3 hrs.	3 hrs.	3 hrs.	—
Total Baking Time	3:20	3:20	3:00	3:00	3:20	3:40	2:50	1:28

*Machine will beep 5 minutes before the end of the cycle. This is the time to add any dried fruits and/or nuts.

**Note: If bread is not removed immediately after baking, and STOP button is not pressed, a controlled Keep Warm phase will begin for each selection. This will help reduce condensation between loaf and Bread Pan, it is best to remove bread as soon as possible after completion of the Baking phase.



MAKING DOUGH AND BAKING BREAD *(continued)*

Always use the freshest ingredients available. By carefully following the simple recipes that come with the Breadman® Bread Baker, you will be able to bake delicious bread every time.

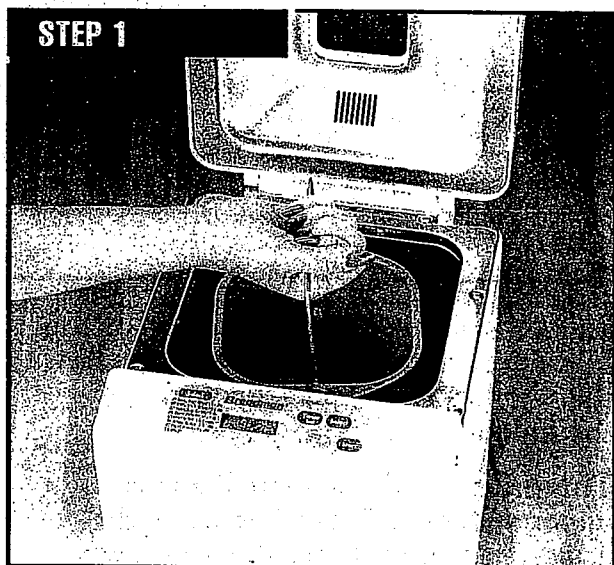

STEP 1
Open the Lid and remove the Bread Pan.

Lift the Bread Pan, with a slight counter-clockwise turn. (The arrow marked "Remove" on the Bread Pan reminds you which way to turn the pan.)

The arrow marked "Front" on the Bread Pan reminds you which way to place the pan.

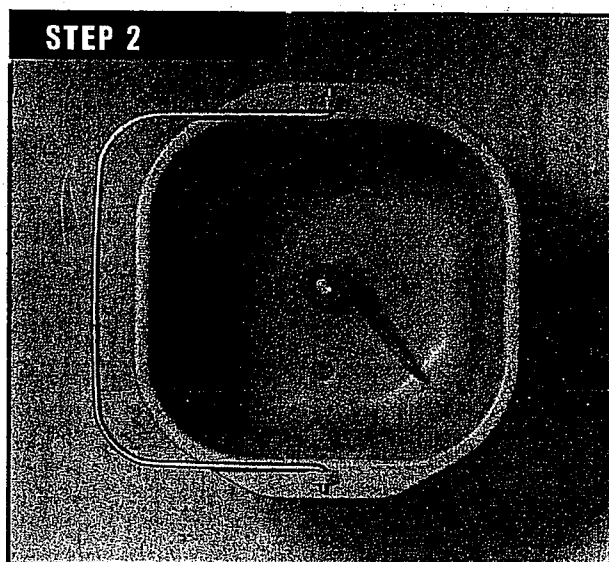

STEP 2
Position the Kneading Paddle on the Drive Shaft as shown.

Match the flat side of the Drive Shaft to the flat part of the hole in the Kneading Paddle. Make sure the paddle is secure.



STEP 3



Place the ingredients into the Bread Pan.

For best results, add all liquid ingredients first. Then, add all dry ingredients **EXCEPT** yeast.

ALWAYS ADD YEAST LAST.

Note: If your recipe contains salt, please add salt with liquid ingredients, keeping it away from the yeast. Salt may activate the yeast prematurely.

STEP 4



Make a small indentation on top of the dry ingredients (not so deep it reaches the wet layer) and add the yeast to the indentation.

This order of adding ingredients is important, especially when using the Timer, because it keeps the yeast away from the liquid ingredients until it's time to knead them together. (Liquid ingredients will activate the yeast.)

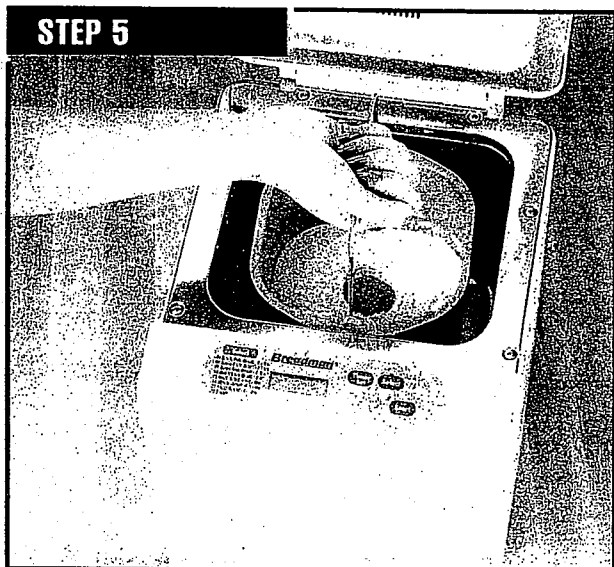

STEP 5

Insert the Bread Pan in the Breadman.[®]
Seat the Bread Pan as shown, then turn the Pan by the Handle clockwise to secure it. (The arrow marked "Lock" reminds you which way to turn the Handle.)

Close the Lid and plug in the Breadman.[®]

When you first plug it in, the Breadman[®] beeps once.

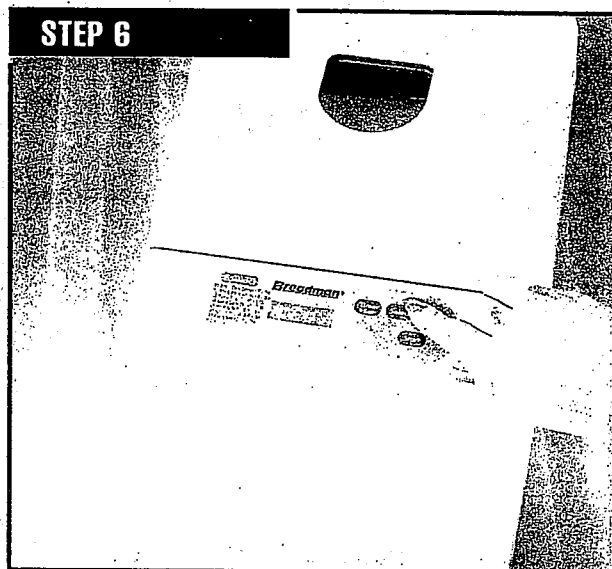

STEP 6

Press the Select button to choose the cycle you want.

Press Select once to choose "White (Dark Crust), 2 lbs." Each time you press Select again, the Display Window shows the next selection.



If you forget to press the **SELECT** button, the "White (Regular Crust, 1-1/2 lbs.)" Cycle will **AUTOMATICALLY BE SELECTED**.

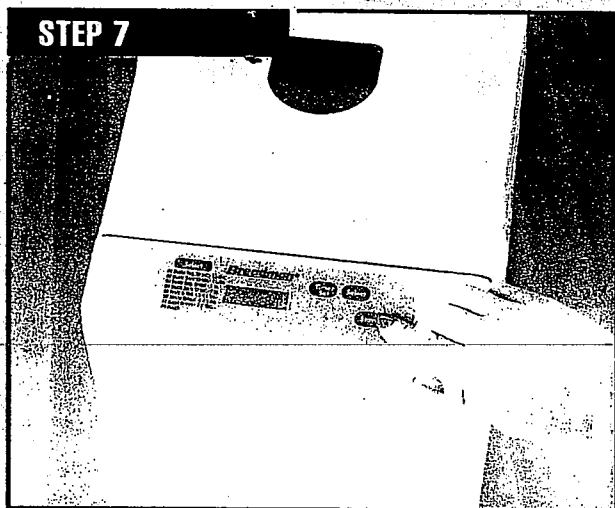

Press **START** to begin the Kneading and/or Baking cycle.

First, the Breadman® mixes the ingredients for one minute. Then, it begins the Kneading process. During this process, the yeast begins to activate, and normally the Viewing Window begins to fog. (This will clear so you can see the progress of your loaf.) The Breadman® will stop Kneading after a few minutes to let the dough rise before baking.

If you plan to make bread or dough with raisins, dried fruit or nuts, add these ingredients when the Breadman® beeps several times, 5 minutes before the end of the second Kneading cycle, in the Fruit & Nut function.

When baking bread, the machine will beep at the end of the baking cycle showing **END** in the Display Window. Although Breadman® has a 3-hour "Keep Warm" cycle, the baked bread is best removed from the appliance and the pan immediately after baking. Use **oven mitts** to carefully remove the Bread Pan.

If you are only making dough, the Breadman® will beep to let you know when the dough is ready to be removed. Press the **STOP** button, remove dough and hand shape according to the recipe.

*For all cycles except Rapid Bake and Dough, the machine preheats for 4 - 5 minutes before Kneading starts.

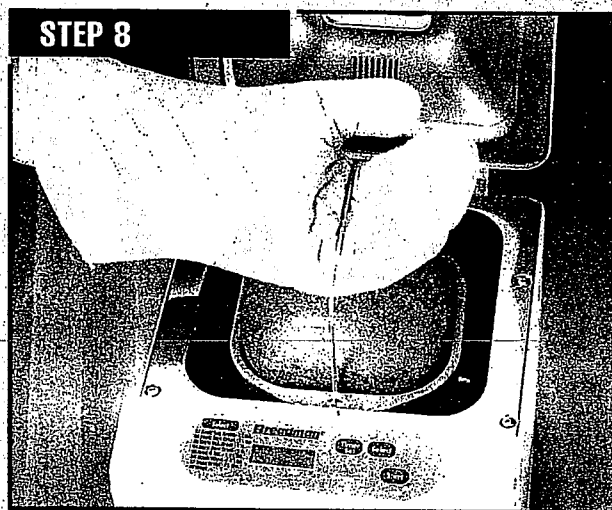

When your bread is done, the Breadman® will beep. This indicates that the Baking phase is completed. Press the **STOP** button, then put on your oven mitts and remove the Bread Pan.

Remember that the Bread Pan and your loaf are both very hot! Be careful not to place either on a tablecloth, plastic surface, or other surface that might scorch or melt.

For all cycles except Dough:

If the bread is not removed immediately after baking and if the **STOP** button is not pressed, a controlled Holding/Keep Warm cycle will begin and the machine will automatically shut off after 3 hours. While this will help prevent the bread from becoming soggy, *for best results*, remove bread immediately after Baking cycle is complete.

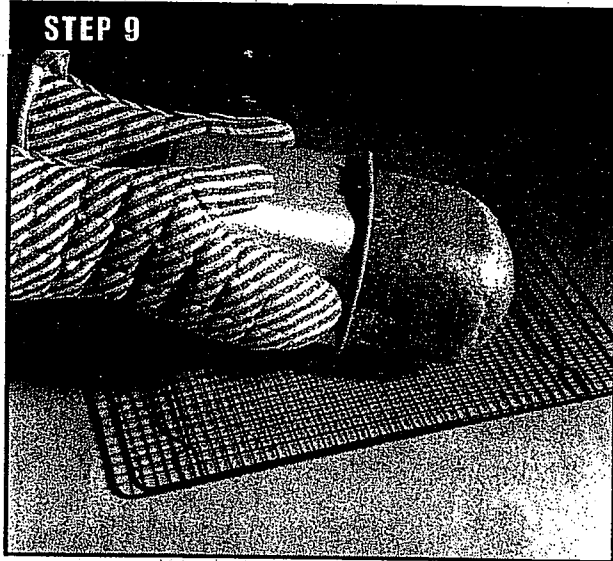

Remove the loaf from the Bread Pan.

Turn over the Bread Pan a few inches from the countertop and gently shake out the loaf. It's best to remove the loaf as soon as the Breadman® has finished baking.

Place the loaf on a wire rack or other ventilated cooling surface to cool. Bread should be cooled slightly (15 to 30 minutes) before it is sliced.

If necessary, remove the Kneading Paddle from the loaf.

Sometimes the Kneading Paddle will stick in a loaf of bread. If it does, use a non-metal utensil to gently remove it, taking care not to scratch the Kneading Paddle.

When you are done using the Breadman®, be sure to unplug it.



USING THE TIMER

You can preset your Breadman® Bread Baker to cook bread from 4 hours to 13 hours in advance.

NOTE: Do not use the Timer if your recipe includes eggs, fresh milk or other ingredients that may spoil. The Breadman Timer can not be used for Rapid Bake or Dough cycles.

To preset your Breadman®, follow these steps:

1. Add the ingredients as usual, taking care not to let the yeast and liquid ingredients contact one another.
2. If your recipe contains salt, please add salt with liquid ingredients, keeping it away from the yeast. Salt may activate the yeast prematurely.
3. Close the Lid and plug it in.
4. Select the Baking Cycle you want. After the **START** button is pressed, the Display Window will show the time needed to bake.
5. Press the **TIMER SET** button once for each 10 minutes you want to add. The amount of time you set is shown in the Display Window.
 - To fast forward time, continually press the **TIMER SET** button.
 - For example, if it is 8 o'clock and you want a loaf of bread ready at 1 o'clock, press the **TIMER** button until the display reads 5:00, meaning it will finish baking in five hours.

NOTE: Actual baking times will not change.

6. Press **START** to begin the Timer. The colon (:) in the time displayed begins to flash, letting you know the Timer is started. When the Display Window indicates **END**, baking is completed.
7. If you make an error after you've activated the program and want to start over, press **STOP**. The Timer will clear and you can begin again.



USING THE TIMER *(continued)*

For Best Results

- Take care to measure ingredients accurately, using a good set of measuring cups and spoons, or a good scale. Make sure to level all dry ingredients as you measure them. Inaccurate measuring could cause unexpected results in your loaf of bread.
- In particular, be precise in measuring the water.
- After placing all the ingredients in the Baking Pan, wait 10 minutes before pressing **START**, or use the Timer to add 10 minutes to the total processing cycle.

**See page 12 for detailed instructions.*

- Use fresh ingredients.
 - Since moisture is an enemy to flour, be sure to store your flour in an airtight container.
 - To keep your yeast active, store it in an airtight container in your refrigerator.
- *Speaking of fresh* — when using the Timer, we recommend setting it for as short a time as possible. Because ingredients are partially combined in the Bread Pan, the dough may tend to deteriorate if left too many hours, especially on a warm or humid day.
- Although you can preset the Breadman® for dough, we only recommend this for prepackaged mixes. Eggs and dairy products can easily spoil.
- Keep the Lid closed during the Baking cycle. Opening it causes uneven baking.
- After your bread has cooled completely, store it in a plastic bag or plastic wrap to prevent it from drying out.



CLEANING INSTRUCTIONS

The Bread Pan and Kneading Paddle have non-stick surfaces that make cleaning easy.

1. After baking each loaf of bread, unplug the Breadman® and discard any crumbs.
2. Remove the Bread Pan from the Oven and the Kneading Paddle from the Bread Pan. Then, as needed, wash the Bread Pan and Kneading Paddle inside and out with warm, soapy water. Avoid scratching the non-stick surfaces. **DO NOT PUT THE PAN IN A DISHWASHER.**

If the Kneading Paddle is stuck to the Drive Shaft, pour warm water in the Pan to loosen it.
DO NOT USE EXCESSIVE FORCE.

3. Wipe the inside of the Lid and Oven with a damp cloth or sponge. If any residue has scorched on the heating plate or elsewhere, wipe with a non-abrasive scrubbing pad and wipe clean.

Do not use vinegar, bleach, or harsh chemicals to clean the Breadman®.

Do not soak the Bread Pan for a long period of time — this could interfere with the free working of the Drive Shaft.

Be sure the machine is completely cooled before storing.

The inner casing contains the heating element and drive base. Therefore, when cleaning, **NEVER pour water, solvents or cleaning solutions into this area.**

Caution

To avoid electric shock, unplug the Breadman® before cleaning!



TROUBLE SHOOTING

Symptom	Possible Solutions
Display Window shows nothing	Make sure the machine is plugged in. If nothing appears in the Display Window, unplug and plug in again.
START button doesn't start the machine	Make sure the machine is plugged in. If nothing appears in the Display Window, press Select to choose your Baking cycle. (You must select a Baking cycle before pressing START.) If the baking area is too hot, the Breadman® will not start because of an automatic safety feature. Remove the Bread Pan with your ingredients, and wait until the Breadman® cools down — about 20 minutes — before starting a new loaf.
Can't set the Timer	If you selected either the Rapid Bake or Dough cycle, you should not use the Timer. This is because the ingredients should be processed immediately for these cycles.
After starting, the Display Window flashes "H:E"	If the bread machine is too hot, it will not start because of an automatic safety feature. Remove the Pan and let the bread machine cool down until "H:E" disappears and the selection reappears. You may then start the cycle.
The bread machine doesn't mix the ingredients	On preheating the (:) in the Time Display flashes and Kneading Paddle will not move. There is a 4 - 5 min. rest period on some of the cycles in which there will be no movement in the pan for 4 - 5 min. If the Kneading Paddle does not operate after this period of time, check to see if the Kneading Paddle is engaged in the machine correctly.
The Breadman® stopped and "000" flashes	This happens if you press the STOP button, if you unplug the machine, or if there is a power outage. In each case, the Breadman® can't be restarted for this cycle. Discard the contents of the Bread Pan and start again with new ingredients.



TROUBLE SHOOTING (continued)

Symptom	Possible Solutions
The bread machine does not bake the bread	The Dough program was selected. To bake the bread, choose the appropriate program for baking bread.
Bread has an offensive odor	Check to be sure you added the correct amount of yeast. Measure carefully—too much yeast will cause an unpleasant odor and may cause the loaf to rise too high. Be sure to use only fresh ingredients.
Baked bread is soggy or the bread's surface is sticky	Remove the bread from the Bread Pan as soon as it is done baking. Leaving it in the pan allows condensation to collect on the sides touching the pan. Also be sure to cool the loaf on a wire rack; cooling it on a countertop causes the side next to the counter to become soggy.
The Kneading Paddle was stuck in the bread	Make sure the Kneading Paddle is mounted properly before adding ingredients to the Bread Pan and baking. Sometimes denser or crustier loaves of bread may pull the Kneading Paddle out with them when you remove the loaves after baking. When this happens, use a non-metal utensil and gently remove the blade from the bottom of the loaf.
The bread rose too high	Make sure not to add too much yeast, water or flour. Too much of any of these may cause the loaf to rise more than it should.
The bread didn't rise enough	Did you add enough yeast, water or sweetener? Make sure to add ingredients in the proper order: liquids, dry ingredients, yeast. Make sure yeast doesn't get wet until the Breadman® mixes the ingredients together. <i>Note: Typically, bread made with whole grain flours will not rise as high as bread made with bread flours.</i>



TROUBLE SHOOTING *(continued)*

Symptom	Possible Solutions
The bread didn't rise at all	Make sure yeast is not left out. Also check the date code on the yeast and that it is always the last ingredient put into the pan. Make sure the yeast doesn't come into contact with salt or any liquid ingredients.
The dough looks like batter, or the dough ball is still sticky, not smooth and round	During the Kneading process, add 1 tablespoon of flour at a time, letting it mix in well. For most breads, your dough ball should become round, smooth, not sticky to the touch, and should bounce back when you press it with your finger.
The dough ball is lumpy or too dry	During the Kneading process, add 1 tablespoon of water at a time, letting it mix in well.
The bread caved in	Make sure liquids are measured correctly. Next time, reduce your liquids by 2 tablespoons. If you're using fruits or vegetables, make sure they are well drained.
:END: displays	The Baking cycle is completed.



NOTES

[Faint, illegible text on lined paper]



NOTES

A series of horizontal lines for writing notes, consisting of 21 parallel lines spaced evenly down the page.

ONE-YEAR LIMITED WARRANTY

This Salton/MAXIM product warranty extends to the original consumer purchaser of the product.

Warranty Duration: This product is warranted to the original consumer purchaser for a period of one (1) year from the original purchase date except for the Bread Pan and Kneading Paddle which are warranted for 90 days.

Warranty Coverage: This product is warranted against defective materials or workmanship. This warranty is void if the product has been damaged by accident, in shipment, unreasonable use, misuse, neglect, improper service, commercial use, repairs by unauthorized personnel or other causes not arising out of defects in materials or workmanship. This warranty is effective only if the product is purchased and operated in the USA, and does not extend to any units which have been used in violation of written instructions furnished by Salton/MAXIM Housewares, Inc., or to units which have been altered or modified or to damage to products or parts thereof which have had the serial number removed, altered, defaced or rendered illegible. Wear and tear for Bread Pans and Paddles is not considered a manufacturer's defect.

Warranty Disclaimers: This warranty is in lieu of all warranties expressed or implied and no representative or person is authorized to assume for Salton/MAXIM Housewares, Inc. any other liability in connection with the sale of our products. There shall be no claims for defects or failure of performance or product failure under any theory of tort, contract or commercial law including, but not limited to, negligence, gross negligence, strict liability, breach of warranty and breach of contract.

Warranty Performance: During the above one-year warranty period, a product with a defect will be either repaired or replaced with a reconditioned comparable model (at Salton/MAXIM's option) when the product is returned to the Salton/MAXIM facility. The repaired or replacement product will be in warranty for the balance of the one-year warranty period and an additional one-month period. No charge will be made for such repair or replacement.

Service and Repair

Should the appliance malfunction, you should first call toll-free 1-800-233-9054 between the hours of 9:00 am and 5:00 pm Central Standard Time and ask for CONSUMER CUSTOMER SERVICE stating that you are a consumer with a problem.

In-Warranty Service: For an appliance covered under the warranty period, no charge is made for service or postage. Call for pre-paid return mailing label. (U.S. Customers Only)

Out-of-Warranty Service: A flat rate charge by model is made for out-of-warranty service. Include \$15.00 for return shipping and handling.

Salton/MAXIM cannot assume responsibility for loss or damage during incoming shipment. For your protection, carefully package the product for shipment and insure it with the carrier. Be sure to enclose the following items with your appliance: any accessories related to your problem; your full return address and daytime phone number; a note describing the problem you experienced; a copy of your sales receipt or other proof of purchase to determine warranty status. C.O.D. shipments cannot be accepted.

Return the appliance to:

ATTN: Repair Department
Salton/Maxim Housewares, Inc.
708 SOUTH MISSOURI ST.
MACON, MO 63552

For more information on Salton/MAXIM products:

visit our website: URL <http://www.breadman.com> or E-mail us at SALTON 550@aol.com

Handwritten text at the top of the page, possibly a header or title, which is mostly illegible due to fading and blurring.

First main paragraph of handwritten text, containing several lines of illegible script.

Second main paragraph of handwritten text, continuing the illegible script.

Third main paragraph of handwritten text, continuing the illegible script.

Fourth main paragraph of handwritten text, continuing the illegible script.

Fifth main paragraph of handwritten text, continuing the illegible script.

Final line of handwritten text at the bottom of the page, possibly a signature or date.



HEALTHY

BREAD

1-2 pound

RECIPES

& menu planner

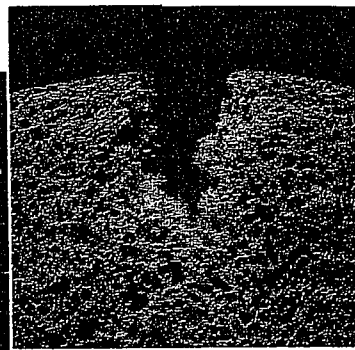



Contents

Introduction	1
Health Benefits of Whole Grain Breads.....	2
Recipe Ingredients	3
Bread Ingredients	4-5
Grain Glossary	6
Measuring and Measuring Equivalents	7
Sample Menus Using Whole Grain Breads	8

RECIPES

Basic White/French Bread	9
Egg Bread	9
Variation: Brioche (Rich White Bread)	9
Honey Banana Whole Wheat Bread	10
Light Whole Wheat Bread.....	10
Dark Rye (Pumpernickel) Bread	11
Light Caraway Rye Bread	11
Cinnamon Raisin Bread	12
Anadama Oatmeal Bread	12
Seven Grain Bread.....	13
Two Cheese Bread	13
Whole Wheat Zucchini Herb Bread	14
Yogurt Whole Wheat Bread	14
Sourdough Bread	15
The Breadman's World Famous, All-Natural, No-Butter Cinnamon Rolls	16
Pizza Dough	17



Introduction

Since biblical times, bread has been considered “the staff of life.” Today whole grains are still recognized as the foundation of a nutritious diet. The USDA’s Food Guide Pyramid, the new food guideline that replaces the old four food groups, recommends that whole grains comprise nearly 50 percent of our daily calories. According to these guidelines, we should eat six to eleven servings of whole grains every day.

This USDA recommendation is easy to follow with your Automatic Bread Baker. Specially designed to handle whole grains, the Breadmaker bakes up deliciously healthy nutrition with just the touch of a button. And you can guarantee that your family gets only the freshest, most health-giving breads because you are in control. You choose the flour, you select the sweetener (if any), and you decide when the baking process will start. Whenever you desire, you can have an aromatic loaf of just-baked bread, bursting with all the goodness of whole grains and containing no hidden additives, saturated fats, excess sodium or refined sugars.

Let this Recipe and Menu Planner be the beginning of your health-enhancing adventures with bread baking. The suggestions provided here are just that — suggestions. Please feel free to use your imagination and enjoy experimenting with your favorite ingredients.



Health Benefits of Whole Grain Breads

Refined grains, and the products made from them, have literally been stripped of their natural goodness. Commonly listed as white flour, wheat flour or even enriched flour, refined grains are almost devoid of the fiber and important nutrients that were intact in the original grain. Besides being processed, white flour is often bleached to achieve that snow-white appearance. All this adulteration has changed a wholesome food into a food fragment containing little nutritional benefit and very little character.

Fiber-rich whole grains and whole grain flours have been the focus of many scientific studies demonstrating that they reduce the risk of diverticulosis, colon and rectal cancer, and atherosclerosis. Diets containing adequate fiber inherently tend to be lower in fat and calories, especially saturated fat and cholesterol, which may contribute to the reduced risk factor.

Fiber is the primary reason that whole grain breads and other products are so satisfying to eat. Fiber is filling, and because it contains so few calories, it is an excellent part of the low-fat, high complex carbohydrate diet recommended for better health.



Recipe Ingredients

Bread recipes begin with a very basic set of ingredients: water, flour, salt and yeast. To this short list, you can add a variety of interesting and delicious ingredients that will give your breads the individuality you are looking for. Seeds, nuts, nut butters, dried fruits, raisins, dates, apples, berries, herbs, spices, carob powder, vegetables and bran are just a few of the many ingredients you can use to create hundreds of unique and flavorful breads.

Purchase fresh ingredients whenever possible for the best taste and results. Dried foods, such as fruits, vegetables, herbs and spices will keep for a virtually unlimited time if stored in a cool, dry environment. Store produce, oils, whole grain flours and other perishable foods in the refrigerator for longer life and retention of flavor. Glass and hard plastic containers with tight fitting lids are preferable for storing most foods; they keep the aromas in but do not expose the foods to the potentially harmful ingredients found in some plastic containers. Plastic may absorb strong odors, so for spicy or pungent ingredients, always use glass.

You will probably be able to find most, if not all, of the ingredients needed for baking healthy breads at your supermarket; consumer demand has helped many grocers become more health conscious. If some of the ingredients are not available yet in your grocery store, your health food store is certain to stock them.

For understanding how bread ingredients work, read the following section.



Bread Ingredients

The only ingredients needed to make bread are: flour, water and yeast — *the rest is personality*. Learn a little about what each of the other ingredients add and you will be prepared to create your own delicious recipes.

Flour

Bread Flour Bread Flour can be used when the recipe calls for bread or all purpose flour. It has more gluten than all purpose flour and is a better choice when mixing white flour with whole grain flours. Bread flour often has ascorbic acid (vitamin C) added as a dough conditioner. This creates a larger holed grain sought by many bakers.

All Purpose Flour This is fine whenever the recipe calls for all white flour. It will make a smaller grained bread than bread flour. All purpose flour and bread flour are wheat flours with the bran and germ removed and B vitamins added.

Gluten Gluten is a mixture of proteins responsible for the elastic (glue) quality of dough. As yeast grows, it releases bubbles of carbon dioxide that become trapped by the stretchy gluten. Wheat has a high gluten content while other grains have little or none. Use it in recipes that call for whole grain flours to prevent the top of the loaf from collapsing. Buy gluten in any health food store.

Whole Wheat Whole wheat flour adds a nutty flavor. It also increases the nutritional and fiber content of a recipe. It has less gluten than white flour, and used alone, will create a dense loaf. Many of our recipes use a mixture of whole wheat and bread flour to create a light textured, nutritious bread.

Other Whole Grains Rye, buckwheat, spelt, oats and other whole grains add wonderful flavors and nutrients to bread but do not have gluten needed to rise very high. Mix 3 to 4 parts of wheat flour for each part non-wheat (or add a few Tbls. of gluten) to make sure your dough will rise.

Eggs Eggs add color, richness, protein and structure to bread. They also serve as a liquid. A large egg adds about 3 Tbl. of liquid, and an extra large egg, 1/4 cup (4 Tbl.) When adding or eliminating eggs, adjust the other liquids in your recipe. All the recipes given here were made with large sized eggs.

Butter and Oil Fats add richness to bread and keep it fresher longer, which is why breads without any butter or oil are great fresh, but get stale very fast. They also add calories — about 100 calories per loaf for every tablespoon of added fat.



Bread Ingredients *(continued)*

Milk Adding milk creates a tender textured, mellower flavored bread. Yogurt, buttermilk, and sour cream make moist doughs, and add a slight tangy flavor. Milk also increases the protein content of bread. Fresh milk is fine when making recipes to start immediately. When setting the timer ahead several hours, use dry milk to prevent spoiling.

Yeast All the recipes here use dry active yeast — the small packages contain 1 Tbl. (1/4 oz.). If you bake often, however, it is convenient to buy yeast loose in jars and measure out only the amount you need. Check expiration date before buying or using and keep yeast refrigerated or in the freezer.

Salt Salt adds flavor to bread and tempers the rising process. If you are watching your salt intake, reduce the amount of added salt or leave it out completely. Dough, however, rises more quickly without salt, so add a bit less yeast as you reduce the salt.

Sweeteners Yeast does not need a sweetener to rise — flour serves as its food — but it speeds up the process. Sweeteners, of course, add flavor, and keep bread moist longer. Sugar adds pure sweetness, while brown sugar, honey, maple syrup and molasses also add distinctive flavors. Molasses, the strongest flavored sweetener, is sometimes used to darken recipes.



Grain Glossary

Amaranth This petite golden grain is moving quickly from the “unusual” grain category to one of the mainstream acceptance. A mainstay in the diet of the Aztecs, amaranth was considered a strength-giving food, probably due to its high protein profile. Both the grain and its flour offer a distinct flavor when added to your favorite bread recipes.

Barley This grain has a hearty, earthy flavor and produces a dense loaf of bread due to its low gluten content. Barley is a good substitute for white flour in recipes, but should be cut with a lighter flour when several cups are being used at a time.

Buckwheat Technically not a grain, buckwheat is really the fruit of a plant related to rhubarb. Its flour (ground buckwheat seed) and groats are both useful for unique bread baking. The flavor has been described as a combination of rosemary and green tea.

Corn The only grain eaten fresh as a vegetable, corn (also known as maize) is available in a wide variety of colors. Judge the freshness of cornmeal and flour from its sweet and delicate flavor. Blue cornmeal, a beautiful hue when dry, becomes a purplish color when cooked.

Kamut This “ancient” wheat grain is available as a whole grain, rolled grain, flour and cereal. People who are wheat sensitive have reported a tolerance to kamut products, though this is still being investigated.

Millet Commonly used to feed birds, millet lends a delightful crunch when added in whole grain form to recipes. People who are allergic to other grains have had luck with millet. It is considered to be the most digestible grain around.

Oat Rolled oats and oat flour are welcome additions to almost any bread recipe. Their delicately light texture and flavor embody the pleasures of home-baked goodness. Grind your own oat flour by chopping oat flakes in the blender until they reach the desired consistency.

Quinoa This recently rediscovered grain is found in whole form, in flour and in prepared products like pasta. When added to bread recipes, it imparts an earthy flavor matched by no other grain, and it packs a protein punch.

Rye This cold-weather gain is famous for its use in savory pumpernickel and caraway seed-rich rye breads. Rye has very little gluten and rises with the assistance of wheat flours.

Spelt Another of the “ancient” super grains, spelt has been reintroduced with resounding success. Use it in bread recipes in place of wheat for a slightly nutty flavor.

Wheat Wheat and whole wheat flour are the basis for most bread recipes. The gluten content of wheat provides the strength and resiliency necessary for a high and sturdy loaf.



Measuring

Measure all ingredients carefully. You will need two types of measuring cups, liquid and dry — it is very difficult to measure dry ingredients accurately with liquid measures.

Liquid measures: are either glass or clear plastic, graduated cups.

Dry measures: sell in sets of 5 nested cups (1/8, 1/4, 1/3, 1/2, and 1 cup) or 5 nested spoons (1/8, 1/4, 1/2, and 1 teaspoon, plus 1 Tablespoon).

Measuring Equivalents

	Dry	Liquid
1 cup	16 Tbl.	8 oz.
1/2 cup	8 Tbl.	4 oz.
1/3 cup	5 Tbl. & 1 tsp.	2.7 oz.
1/4 cup	4 Tbl.	2 oz.
1/8 cup	2 Tbl.	1 oz.
1 Tbl.	3 tsp.	1/2 oz.



Sample Menus Using Whole Grain Breads

Sample 1

Breakfast

Fresh orange-grapefruit juice
Slice Honey Banana Whole Wheat Bread
(page 10) toasted,
with 1 tablespoon peanut butter
Banana

Mid-Morning

Slice Anadama Oatmeal Bread (page 12)
with 1 tablespoon apple butter

Lunch

Sandwich with humus, celery,
sprouts, tomato, cucumber
on Yogurt Whole Wheat Bread
(page 14)

Afternoon Break

Fresh fruit or veggie sticks

Dinner

Baked potato with skin,
topped with salsa
Black bean and rice salad,
topped with chilies and tomatoes
Slice Dark Rye (Pumpnickel) Bread
(page 11)
Raw mixed vegetable salad

Evening Snack

Air-popped popcorn
or fresh fruit

Sample 2

Breakfast

Fresh pineapple juice
Slice Cinnamon Raisin Bread
(page 12), toasted
1/2 cup plain low or non-fat yogurt

Mid-Morning

Whole Wheat Zucchini Herb Bread (page 14)

Lunch

Wild greens salad with
rice vinegar dressing
Slice Light Caraway Rye Bread (page 11)
Minestrone soup
Steamed or stir-fried vegetables

Afternoon Break

Fresh tomato-cucumber-parsley
juice, with a dash of hot sauce
or lemon juice if desired

Dinner

Poached fish with lemon
Slice Seven Grain Bread (page 13)
Steamed asparagus and carrots
Fresh spinach salad

Evening Snack

Low-fat baked corn chips
with salsa

Note: These bread recommendations are suggestions only. Your favorite bread recipes may be substituted in any of the above meal plans.



Please Note: The following recipes were created using the "Basic Bread" setting.
Please Note - Salt and sugar should go in with water. Do Not put in with yeast.

RECIPES

Basic White/French Bread

Makes a 1-1/2 lb. loaf

1-1/8 cup warm water
1-1/2 Tbl. vegetable oil (optional)
3 cups all purpose flour
1-1/2 tsp. salt
2 tsp. active dry yeast

Add all ingredients to bread pan in the order given.

Makes a 2 lb. loaf

1-1/2 cup warm water
2 Tbl. vegetable oil (optional)
4 cups all purpose flour
1-1/2 tsp. salt
2-1/2 tsp. active dry yeast

Egg Bread

Makes a 1-1/2 lb. loaf

2/3 cup warm water
1-1/2 Tbl. vegetable oil
2 eggs
3 cups all purpose flour
2 tsp. sugar
1-1/2 tsp. yeast

Add all ingredients to bread pan in the order given.

Makes a 2 lb. loaf

1 cup warm water
2 Tbl. vegetable oil
2 eggs plus enough water to make 1/2 cup
4-1/4 cups all purpose flour
1 Tbl. sugar
2 tsp. yeast

Variation:

Brioche (Rich White Bread)

Use the egg bread recipe with the following substitutions:

- Replace the water with milk
- Increase the oil (or use butter) to 2 Tbl. for 1-1/2 lb. loaf, and 3 Tbl. for the 2 lb. loaf.
- Increase the sugar to 2 Tbl. for 1-1/2 lb. loaf, and 3 Tbl. for the 2 lb. loaf.



Honey Banana Whole Wheat Bread

This delicious loaf tastes like a sweet banana bread — only much healthier — and it makes a great peanut butter sandwich.

Makes a 1-1/2 lb. loaf

1/2 cup warm water
1 Tbl. butter or vegetable oil
3 Tbl. honey
1 egg
1/2 tsp. vanilla
1 cup whole wheat flour
1-1/4 cup bread flour
1 small banana, sliced
1-1/2 tsp. poppy seeds
1/2 tsp. salt
1-1/2 tsp. dry yeast

Add all ingredients to bread pan in the order given.

Makes a 2 lb. loaf

2/3 cup warm water
1-1/2 Tbl. butter or vegetable oil
1/4 cup honey
1 egg
1/2 tsp. vanilla
1-1/2 cup whole wheat flour
1-1/2 cup bread flour
1 banana, sliced
2 tsp. poppy seeds
1 tsp. salt
2 tsp. dry yeast

Light Whole Wheat Bread

Makes a 1-1/2 lb. loaf

1-1/4 cup warm water
1 Tbl. vegetable oil
2 Tbl. honey
3/4 cup whole wheat flour
3/4 cup whole wheat pastry flour
1 cup bread flour
1/4 cup gluten
1/2 tsp. salt
1-1/2 tsp. dry yeast

Add all ingredients to bread pan in the order given.

Makes a 2 lb. loaf

1-1/2 cup warm water
1 Tbl. vegetable oil
3 Tbl. honey
1 cup whole wheat flour
1-1/4 cup whole wheat pastry flour
1-1/4 cup bread flour
1/3 cup gluten
1/2 tsp. salt
2 tsp. dry yeast



Dark Rye (Pumpernickel) Bread

Pumpernickel makes the best deli, cheese or vegetable sandwich. If you want an even darker colored bread, increase the amount of cocoa or add a teaspoon of instant espresso.

Makes a 1-1/2 lb. loaf

1-1/4 cup warm water
1 Tbl. vegetable oil
1-1/2 Tbl. molasses
1 cup rye flour
1-1/2 cup bread flour
1/2 cup whole wheat flour
1/4 cup gluten
3 Tbl. dry milk powder
1 Tbl. caraway seeds
1 Tbl. cocoa
1 tsp. salt
1-1/2 tsp. dry yeast

Add all ingredients to bread pan in the order given.

Makes a 2 lb. loaf

1-1/2 cup warm water
1-1/2 Tbl. vegetable oil
2 Tbl. molasses
1-1/2 cup rye flour
1-1/2 cup bread flour
1 cup whole wheat flour
1/3 cup gluten
1/4 cup dry milk powder
1 Tbl. caraway seeds
1 Tbl. cocoa
1-1/2 tsp. salt
2 tsp. dry yeast

Light Caraway Rye Bread

Makes a 1-1/2 lb. loaf

1 cup warm water
1-1/2 Tbl. vegetable oil
1 egg
1-1/2 tsp. sugar
1 cup rye flour
2 cups white bread flour
3 Tbl. gluten
1 Tbl. caraway seeds
1 tsp. salt
1-1/2 tsp. dry yeast

Add all ingredients to bread pan in the order given.

Makes a 2 lb. loaf

1-1/3 cup warm water
2 Tbl. vegetable oil
1 egg
2 tsp. sugar
1-1/2 cup rye flour
3 cups white bread flour
1/4 cup gluten
1 Tbl. caraway seeds
1-1/2 tsp. salt
2 tsp. dry yeast



Please Note: If your Bread Machine has a "Fruit & Nut Add-In Beeper," please add raisins when time is indicated. If your Bread Machine does not have this feature, add all ingredients to bread pan in the order given.

Cinnamon Raisin Bread

Makes a 1-1/2 lb. loaf

3/4 cup warm water
1 egg
1 Tbl. butter or vegetable oil
2-2/3 cups all purpose flour
3 Tbl. dry milk
2 Tbl. sugar
1/3 cup raisins
1-1/2 tsp. cinnamon
1 tsp. vanilla
1 tsp. salt
1-1/2 tsp. dry yeast

Add all ingredients to bread pan in the order given.

Makes a 2 lb. loaf

1-1/8 cup warm water
1 egg
1-1/2 Tbl. butter or vegetable oil
3-1/2 cups all purpose flour
1/4 cup dry milk
3 Tbl. sugar
1/2 cup raisins
2 tsp. cinnamon
1 tsp. vanilla
1 tsp. salt
2 tsp. dry yeast

Anadama Oatmeal Bread

Colonial American folk stories about the name Anadama accredit Anna's husband for this bread. The hungry fisherman returned home to find Anna gone and a supper of cornmeal mush and molasses. The legend is he cursed her while preparing his own bread from the meal. Our version with oats, makes great sandwiches, and is terrific with chili.

Makes a 1-1/2 lb. loaf

1/4 cup oatmeal
1/8 cup cornmeal
1-1/8 cup boiling water
2 Tbl. butter or vegetable oil
2 Tbl. molasses
1 cup whole wheat flour
2 cups bread flour
1/4 cup dry milk
2 Tbl. gluten
1-1/2 tsp. salt
1-1/2 tsp. dry yeast

Makes a 2 lb. loaf

1/3 cup oatmeal
3 Tbl. cornmeal
1-1/2 cup boiling water
3 Tbl. butter or vegetable oil
3 Tbl. molasses
1-1/4 cup whole wheat flour
2-1/2 cups bread flour
1/3 cup dry milk
3 Tbl. gluten
2 tsp. salt
2 tsp. dry yeast

- Add oatmeal and cornmeal to heat-proof bowl. Pour in boiling water, stirring to prevent lumps.
- Let the mixture cool for ten minutes. Stir, pour it into the bread pan, and add the rest of the ingredients in the order given.



Seven Grain Bread

If you have a health food store nearby that sells grains and flours in bulk, it is easy to buy a small quantity of a variety of flours, and experiment. Don't worry if you can't find all these grains; just use more whole wheat or another grain.

Makes a 1-1/2 lb. loaf

1-1/8 cup warm water
1-1/2 Tbl. vegetable oil
2 tsp. honey
1-1/2 cup whole wheat flour
1/4 cup brown rice flour
1/4 cup spelt flour
1/4 cup buckwheat flour
1/4 cup rye flour
1/4 cup oatmeal
1/8 cup cornmeal
1/4 cup gluten
1 tsp. salt
1-1/2 tsp. dry yeast.

Add all ingredients to bread pan in the order given.

Makes a 2 lb. loaf

1-1/2 cup warm water
2 Tbl. vegetable oil
1 Tbl. honey
2 cups whole wheat flour
1/3 cup brown rice flour
1/3 cup spelt flour
1/3 cup buckwheat flour
1/3 cup rye flour
1/3 cup oatmeal
1/4 cup cornmeal
1/3 cup gluten
1 tsp. salt
2 tsp. dry yeast

Two Cheese Bread

Makes a 1-1/2 lb. loaf

2/3 cup warm water
1 Tbl. butter or vegetable oil
1 egg
2 tsp. sugar or honey
1/2 cup whole wheat flour
2-1/2 cup bread flour
1/4 cup dry milk
1 cup cheddar cheese, grated (3 oz.)
3 Tbl. Parmesan, grated (1/2 oz.)
2 tsp. sesame seeds
1 tsp. salt
1-1/2 tsp. dry yeast

Add all ingredients to bread pan in the order given.

Makes a 2 lb. loaf

1 cup warm water
1-1/2 Tbl. butter or vegetable oil
1 egg
1 Tbl. sugar or honey
3/4 cup whole wheat flour
2-3/4 cup bread flour
1/3 cup dry milk
1-1/3 cup cheddar cheese, grated (4 oz.)
1/4 cup Parmesan, grated (3/4 oz.)
1 Tbl. sesame seeds
1 tsp. salt
2 tsp. dry yeast



Whole Wheat Zucchini Herb Bread

The zucchini blends into the dough, providing half the moisture and subtle flavor. The bread is so light that a 1-1/2 lb. recipe will be the size of most 2 lb. loaves.

Makes a 1 lb. loaf

1/2 cup warm water
2 tsp. honey
1 Tbl. vegetable oil
3/4 cup zucchini, shredded (3 oz.)
3/4 cup whole wheat flour
2 cups bread flour
1/2 tsp. dried basil or rosemary or 1 tsp. fresh
2 tsp. sesame seeds
1 tsp. salt
1-1/2 tsp. dry yeast

Add all ingredients to bread pan in the order given.

Makes a 1-1/2 lb. loaf

3/4 cup warm water
1 Tbl. honey
1-1/2 Tbl. vegetable oil
1 cup zucchini, shredded (4 oz.)
1 cup whole wheat flour
2-1/2 cups bread flour
1/2 tsp. dried basil or rosemary or 1 tsp. fresh
1 Tbl. sesame seeds
1 tsp. salt
2 tsp. dry yeast

Yogurt Whole Wheat Bread

Makes a 1-1/2 lb. loaf

3/4 cup plain nonfat yogurt
1/4 cup warm water
1 Tbl. vegetable oil
1-1/2 Tbl. maple syrup
1-1/8 cup whole wheat flour
1-2/3 cup bread flour
1-1/2 Tbl. wheat germ
1 tsp. salt
1-1/2 tsp. dry yeast

Add all ingredients to bread pan in the order given.

Makes a 2 lb. loaf

1 cup plain nonfat yogurt
1/2 cup warm water
1-1/2 Tbl. vegetable oil
2 Tbl. maple syrup
1-1/2 cup whole wheat flour
2-1/4 cup bread flour
2 Tbl. wheat germ
1 tsp. salt
2 tsp. dry yeast



Sourdough

To capture the tangy flavor of sourdough bread, you need a special fermented batter. This batter called, "starter" is easy to make and keep.

Sourdough Starter

2 cups warm water
1 Tbl. sugar, honey or maple syrup (optional)

2 cups all purpose flour
1 Tbl. dry yeast

- Beat all ingredients together in a 2-quart bowl.
- Cover the bowl with a towel and place it somewhere warm. (Use a towel, not plastic wrap, to allow airborne wild yeast to enter — it will contribute to the unique character and flavor of your starter.)
- The mixture will begin to bubble within a few minutes. Initially, it will double in bulk, but as it begins to ferment, it will settle down.
- Let the mixture sit in a warm place, stirring the liquid back into the batter (as it will separate) once a day for 2-5 days. When the bubbling diminishes and it has a sour, yeasty aroma, it is ready to use.
- Stir the mixture and measure out the amount you need. It will be the consistency of pancake batter.

To keep your starter going:

- Store the finished starter in a sealed jar in the refrigerator.
- Each time you remove some starter to bake, replenish it with equal amounts of flour and water. (If you use 1/2 cup of starter, stir in 1/2 cup each of flour and water.) Then let the starter sit in a warm place for 12 hours and let the yeast bubble and grow again before returning it to the refrigerator.
- A starter can be kept indefinitely — just stir and feed it every week or two. Stirring, removing and replenishing your starter serves to feed the remaining batter.

Sourdough Bread

The yeast in a sourdough starter can replace dry yeast. But the starter yeast works much slower and is typically a three-step method, taking from 6-24 hours for the dough to rise. Our method uses the starter for flavor and adds dry yeast to speed up the process.

Makes a 1-1/2 lb. loaf

1/2 cup sourdough starter
3/4 cup warm water
2 tsp. sugar, honey or maple syrup (optional)
1 Tbl. oil (optional)
3 cups all purpose flour, or bread flour
1 tsp. salt
1-1/2 tsp. dry yeast

Add all ingredients to bread pan in the order given.

Makes a 2 lb. loaf

2/3 cup sourdough starter
1 cup warm water
1 Tbl. sugar, honey or maple syrup (optional)
1 Tbl. oil (optional)
4 cups all purpose flour, or bread flour
1 tsp. salt
2 tsp. dry yeast



The Breadman's World Famous, All-Natural, No-Butter Cinnamon Rolls

Makes 12 rolls

Dough

3/4 plus 2 Tbl. (7 ounces) warm water
1-1/2 Tbl. canola oil
1-1/2 Tbl. honey
1/4 tsp. liquid lecithin
2 cups (9-1/2 ounces) whole wheat flour
3 Tbl. powdered whey
2 tsp. gluten flour
2 tsp. powdered egg substitute
3/4 tsp. fine sea salt
1-1/2 tsp. active dry yeast

Glaze

1/4 cup almond butter
1/4 cup canola oil
1/2 cup honey
1/2 cup powdered whey

For sprinkling on glaze

2 tsp. cinnamon
1/3 cup raisins or chopped nuts (optional)

- Put all the dough ingredients into the bread pan in the order listed. Select "Dough" setting on your machine. Press Start. When the machine beeps, remove the dough. Turn off the machine.
- Place dough on a lightly floured counter or cutting board. Flatten it out slightly and roll it into a 10-by 12-inch rectangle. Stir glaze ingredients together until smooth. Warm gently in a saucepan for a couple minutes if too stiff. Spread half the glaze over the rectangle of dough, leaving a narrow border all around. Sprinkle cinnamon and, if desired, raisins or chopped nuts over the glaze. Beginning at one long side, roll dough into a cylinder and pinch the seam to seal. Cut rolled dough into twelve 1-inch slices.
- Using canola oil, lightly oil a 10-inch round cake pan. Spread remaining glaze mixture over bottom of prepared pan. Set rolls in pan on top of glaze and cover with plastic or damp cloth. Let rolls rise in a warm place until doubled in volume, about 1 hour.
- Preheat oven to 350 °F. Set pan on a baking sheet and bake on the center rack of the oven for 15 to 20 minutes. (Glaze that bubbles over the pan in the oven will spill onto baking sheet.) Invert pan onto a serving platter and let the glaze drip down sides of the rolls. Scrape any remaining glaze from pan onto rolls. Serve warm.



Pizza Dough

A 1 pound recipe makes one medium-thin 12" pizza. A 1-1/2 lb. recipe makes a 15" circle, and 2 lbs. will make 2, 12" pies.

1 lb.	1-1/2 lb.	2 lb.
3/4 cup warm water	1-1/8 cup warm water	1-1/2 cup warm water
1 Tbl. olive oil	1-1/2 Tbl. olive oil	2 Tbl. olive oil
2-1/4 cup all purpose flour	3-1/3 cup all purpose flour	4-1/4 cup all purpose flour
1 tsp. salt	1-1/2 tsp. salt	2 tsp. salt
1 tsp. sugar	1-1/2 tsp. sugar	2 tsp. sugar
1 tsp. dry yeast	1-1/2 tsp. dry yeast	2 tsp. dry yeast

Add all ingredients to bread pan in the order given.

- Set on "Dough-Only" feature if your Bread Machine is equipped with such a selection.
- When done, remove to floured board, if using immediately. Or, place in bowl greased with olive oil, turn dough over to coat it, cover with plastic wrap and refrigerate until ready to use.

Focaccio

- Pat one recipe, any size, of pizza dough into circle about 1/2 inch thick. Place on a baking sheet sprinkled with cornmeal or flour.
- Brush with olive oil and sprinkle with fresh or dried herbs (rosemary, oregano or basil), Parmesan or Romano cheese and black pepper.
- Let dough rise for 15-20 minutes and place in preheated 400°F oven until golden brown.
- **If you have a pizza peel and oven stone:** Place the shaped dough on the cornmeal sprinkled peel, add toppings, let rise, and slide onto the stone in a preheated oven.

