

This Owner's Manual is provided and hosted by [Appliance Factory Parts](#).



# Russell Hobbs RH8CTD701B Owner's Manual

[Shop genuine replacement parts for Russell Hobbs  
RH8CTD701B](#)



[Find Your Russell Hobbs Dryer Parts - Select From 6 Models](#)

----- Manual continues below -----



# Russell Hobbs

8kg Condenser Tumble Dryer

Instruction manual

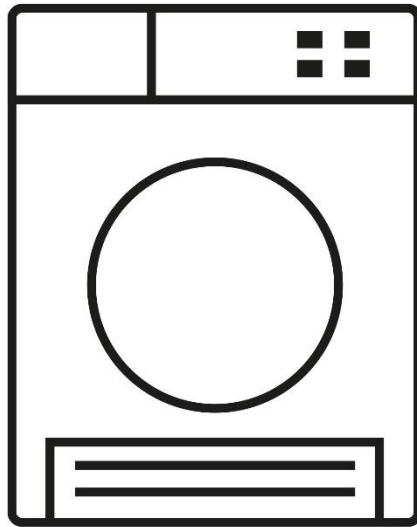

**Model number:  
RH8CTD701 (B)**

**IMPORTANT:  
RETAIN FOR FUTURE REFERENCE**

For Customer Services & Spare Parts please call **0345 208 8750**  
or visit us at **<https://mda.russellhobbs.com>**

## Contents

<b>Safety information</b>	.....	3 - 6
<b>Before using your appliance</b>	.....	7
<b>Control panel</b>	.....	8 - 10
<b>Installation</b>	.....	11 - 12
<b>Operating instructions</b>	.....	13 - 15
<b>Programme table</b>	.....	16
<b>Programs</b>	.....	17
<b>Additional functions</b>	.....	18
<b>Care and maintenance</b>	.....	19 - 22
<b>Trouble shooting</b>	.....	23 - 24
<b>Warning symbols</b>	.....	25
<b>Error Codes</b>	.....	26
<b>Technical specification</b>	.....	27
<b>Energy Efficiency</b>	.....	27
<b>Product fiche</b>	.....	28
<b>Connection to mains supply</b>	.....	29
<b>Guarantee</b>	.....	30
<b>Notes</b>	.....	31

## Safety information

- This tumble dryer is intended for **NORMAL DOMESTIC USE ONLY**.
- Adequate ventilation must be provided around the tumble dryer; 3cm of space between the side walls, rear wall and above the top cover.
- Exhaust air must not be discharged into a flue which is used for exhausting other fumes from appliances burning gas or other fuel.
- Please note it is not recommended that the dryer is placed directly next to ovens, cookers, or other heat sources as the performance of the dryer may be affected.
- Carpet or floor coverings must not obstruct the ventilation openings in the base of the dryer.
- Do not stack the tumble dryer on top of other appliances .
- Any electrical work required to install the appliance should be carried out by a qualified person.
- Under no circumstances should anything other than the recommended articles be placed in the tumble dryer.
- The tumble dryer should be serviced by an appointed service team with genuine parts. Please contact our customer service team for assistance with any repairs.
- It is dangerous to alter or modify the product in any way other than fitting authorized accessories.
- We recommend that the appliance is unplugged each time after use. It should always be disconnected from the electricity supply when not in use for long periods of time.
- The rear of the dryer gets quite hot during use. Position the dryer so that the back is not accessible while in operation, but ensure that the sides have a space available to allow airflow. Before installation, check the product for visible damage. Never install or operate a damaged product.
- Keep pets away from the dryer. Make sure that pets do not enter the dryer. Check the inside of the dryer before using it.
- Fabric softeners, or similar products, should be used in accordance with the manufacturers instructions.
- The appliance must not be installed behind a lockable door, a sliding door or a door with a hinge on the opposite side to that of the tumble dryer, if it prevents the door from being fully opened.

### NOTE:

- **It is important to clean the lint/fluff filter after each drying cycle or the restrictions to airflow will extend drying times and could cause the safety cut-out to trip.**
- **Never spray or pour water on to the dryer to wash it. There is a risk of electric shock**

## Safety information

- Remove all objects from pockets such as lighters and matches
- The mains cable and plug assembly must only be replaced with a genuine part from the manufacturer, please contact the customer support team below .
- It is important to clean fluff from the window of the dryer and around the door seal after each drying cycle.
- This appliance can be used by children aged from 8 years and above and persons with reduced physical, sensory or mental capabilities or lack of experience and knowledge if they have been given supervision or instruction concerning use of the appliance in a safe way and understand the hazards involved. Children shall not play with the appliance.
- Children should be supervised to ensure they do not play with the appliance.
- Children might lock themselves in the machine resulting in risk of death
- Do not allow children to touch the door during operation. The surface becomes extremely hot and may cause skin damage.
- If the supply cable is damaged, it must be replaced by the manufacturer, please contact the customer support team listed below.
- Do not disconnect the plug from the socket by pulling the power supply cord. Always hold the plug when disconnecting.
- Do not attempt to disconnect the plug from the socket with wet hands.
- Do not over bend the power cord.
- Do not put too much stress or heavy weights on the power cord.
- Do not use the appliance if the power cord, socket, or plug are damaged.
- Do not install the appliance close to a fire or heat source.
- Do not rest anything burning, such as a candle, on the appliance.
- Do not install the appliance in a damp environment, the dampness may cause damage to the tumble dryer.
- Do not install the tumble dryer in direct sunlight, or in a hot environment.
- Do not use excessive, or high pressure water when cleaning the tumble dryer.
- Do not use the appliance to dry cushions, quilts, duvets, or similar items.
- Do not place items that have any type of oil soaked in to the fabric, in the tumble dryer. There is a potential the oil could catch on fire.
- Make sure clothing is fully rinsed of detergent and stain remover, before placing in the tumble dryer.
- Do not put combustible liquid or solids, such as oil, gasoline, petrol and alcohol into the appliance or nearby.
- Remove all objects from pockets before use, especially potentially flammable items such as lighters and matches.

## Safety information

- If leakage of a combustible liquid occurs near the appliance, do not connect or disconnect the mains plug.
- This appliance is designed for domestic use only. It should not be used for purposes other than those for which it was designed.
- Only dry laundry that is designed to be machine dried and has label that indicates it is suitable for machine drying. Follow the instructions on each garment label.
- Adjust the feet so that adequate air can circulate freely under the appliance, especially if the appliance is placed on a carpeted floor.
- Do not climb on to the dryer or rest heavy objects, heating devices, or items containing water or liquid on to the dryer. They may all cause damage.
- Repairs must only be carried out by a qualified professional, if there is a problem, please contact the customer service company listed below.
- Make sure items that may cause damage do not get in to the dryer, items such as coins, safety pins, nails, screws, stones. Check the pockets on all the items of clothing.
- Check the appliance is not standing or pressing on the power cable.
- Foam rubber, latex, shower caps, waterproof textiles, rubber backed articles and any other items with foam rubber pads should not be dried in the tumble dryer.
- Always unplug the appliance after use, clean and maintain.
- Do not overload the appliance.
- Do not place clothes that are dripping wet in the tumble dryer.
- Clothes that have been in contact with volatile liquids should not be machine dried. Any fluid should be fully removed from the item before it can be dried.
- Do not dry unwashed items in the tumble dryer.
- Superheating of clothes inside of the dryer can occur if you cancel the programme or in the event of a power failure whilst the dryer is running. This concentration of heat can cause self-combustion so always activate the Refresh programme to cool down or quickly remove all laundry from the dryer in order to hang them up and dissipate the heat
- The final part of a tumble drying cycle occurs without heat (cool down cycle) to ensure the items are not damaged. Do not stop the dryer before it has fully finished the drying cycle.

## Warnings

**WARNING:** Never stop a tumble dryer before the end of a drying cycle, unless the items are removed very quickly

- Do not use a two-way adaptor, or extension lead. The dryer must be connected to its own socket.
- The appliance must not be supplied through an external switching device, such as a timer, or connected to a circuit that is regularly switched on and off by a utility.
- Do not touch the power plug with wet hands. Always pull the plug to unplug the product, otherwise, there will be risk of an electric shock.
- Connect the dryer to a grounded socket with fuse protection. Have the earth connection installed by a qualified electrician. Our company cannot be held responsible for damages/losses resulting from using the dryer without an earth connection as required by local regulations.
- Do not block the air inlets at the front, base, rear and side of your dryer.
- Do not allow fluff to accumulate around the tumble dryer. There is a risk the fluff may cause a fire.
- Do not exceed the recommended maximum load.
- Do not place articles in the dryer if anything other than a water solution has been used in the cleaning process.
- Do not attempt to dry dripping wet articles.
- Do not use the tumble dryer if you suspect that it is damaged in any way. Under no circumstances should you attempt to repair the appliance yourself. Repairs carried out by inexperienced persons may cause serious injury. Contact the helpline on the telephone number listed below.
- Do not let children play with the packaging supplied with this appliance.
- Do not handle laundry in the dryer, until it has stopped completely.
- Check the dryer contains only laundry before closing the door to start it working.

### NOTE:

- **Never use the dryer without a lint/fluff filter or with a damaged lint/fluff filter. Lint filters must be cleaned after each use as indicated in Cleaning the Lint Filter.**
- **Lint filters must be dried after wet cleaning. Wet filters might cause malfunction during the drying process.**
- **Lint accumulation must not be allowed around the tumble dryer (not applicable for appliances intended to be vented to the exterior of the building)**

## Before using your appliance

Before installation, check that all parts are present. If any parts are missing, please contact the customer service team on: 0345 208 8750.

### Feature Diagram

**NOTE:** The drawings in the book may vary from your dryer. They are designed to show the different features of all models covered by this book. Your model may not include all features.

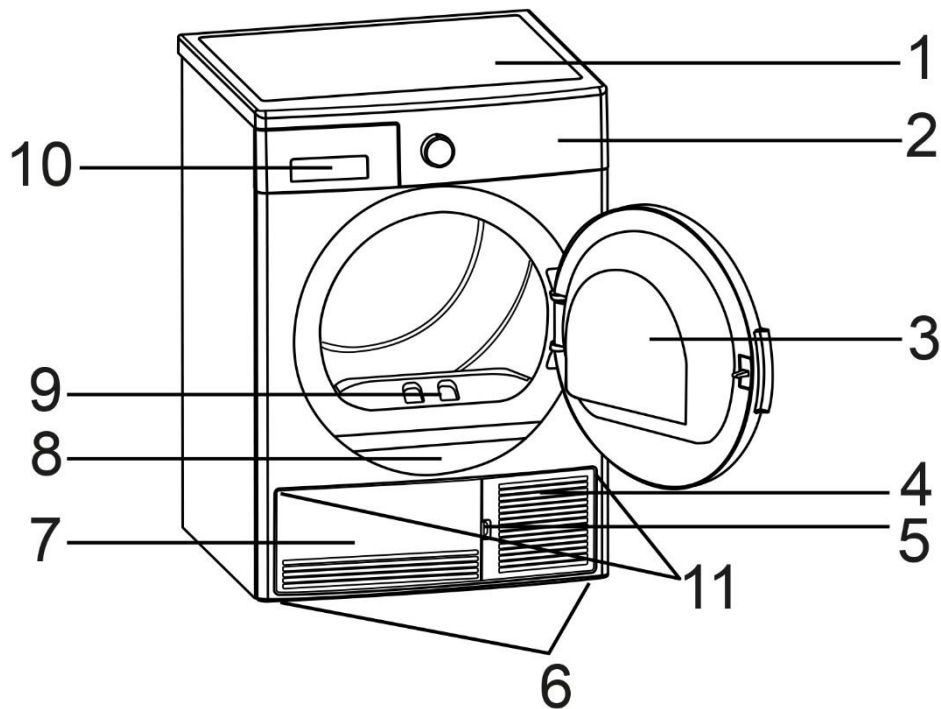

- |   |                        |
|---|------------------------|
| 1. Top Cover                            | 7. Plinth cover        |
| 2. Control panel                        | 8. Rating label        |
| 3. Door                                 | 9. Lint/Fluff filter   |
| 4. Condenser unit & plinth opening slot | 10. Water tank & cover |
| 5. Plinth                               | 11. Ventilation grill  |
| 6. Adjustable feet                      |                        |

## Control panel

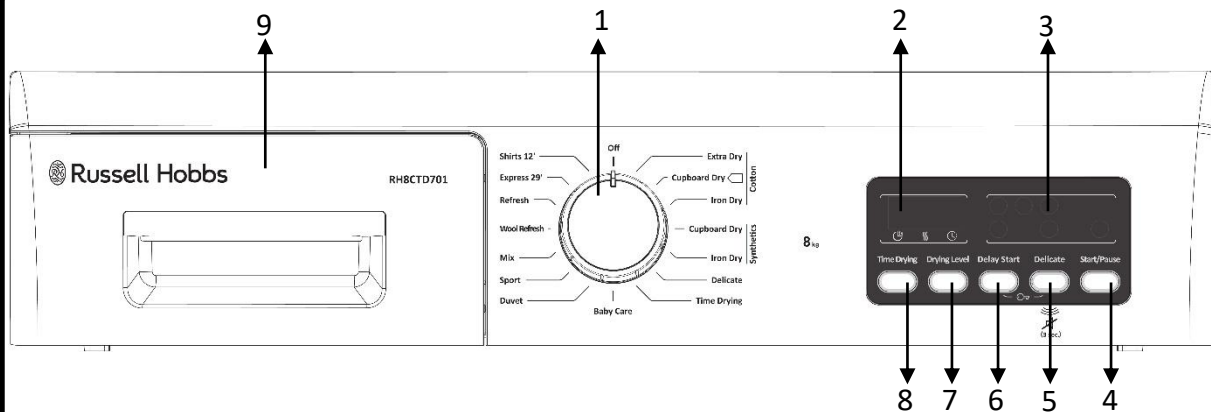

### 1. Programme dial

Choose the correct programme for the load by selecting one of the 15 programmes. Programme table is on page 16.

### 2. LED display

The displays will show the below information:

- Approximate time duration of a programme when selected.
- Counts down the time of a programme after it has been started.
- How long a programme has been delayed by (if selected).
- Error codes, warning symbols, and if the child lock has been activated.

### 3. Additional function indicators & warning indicators

Shows the icons of the additional functions that have been selected & any warning indicators that need actioning; full water tank, lint/fluff filter cleaning & condenser warning indicator.

### 4. Start/pause button

Press to start or pause the drying cycle.

### 5. Delicate function button

Delicate fabrics are dried for a longer time at a low temperature.

### 6. Delay start function button

You can delay the start time of the programme by selecting the 1-hour to 23-hour option. You can activate the desired delay time by pressing the Start/Pause button. When the time is up, the selected programme will start automatically. During the delay time, options compatible with the programme can be activated/deactivated.

Long pressing on Delayed Start button changes delay time continuously.

### **7. Drying level function button (see page 14)**

The humidity level obtained after drying can be increased by 3 levels. This way, level of required dryness can be selected. The levels that can be selected other than the standard setting: 1, 2, 3. After selection, the LED of the relevant drying level will turn on..

### **8. Time drying function button (see page 14)**

When program dial is positioned to Time Drying programme, the length of time can be selected by pressing Time Drying button or by pressing and holding the Time Drying button the time will be changed continuously. The Time Drying program will start by pressing Start/Pause button.

### **Buzzer cancel**

The dryer gives an audible warning when program selection knob is turned, buttons are pressed and at the end of programme. To cancel the warnings, press and hold the "Delicate Option" button for 3 seconds. When you press the button, you will hear an audible warning that the option has been cancelled.

### **Child lock**

There is a child lock option to avoid changes in the programme when keys are pressed during the programme. To activate the child lock, press and hold the "Delay Start" and "Delicate" keys simultaneously for 3 seconds. When the child lock is active, all keys will be deactivated and "CL" will be displayed on display for 2 seconds and an audible warning will be heard. The Child lock will be deactivated automatically at the end of the programme. When deactivating the child lock, "CL" will visualize on display for 2 seconds and an audible warning will be heard.

When the product is running or the child lock is active, if you turn the programme selection knob, you will hear an audible warning and "CL" will visualize on display for 2 seconds. Even if you set the programme knob to another programme, the previous programme will continue running. To select a new programme, you need to deactivate the child lock and then set the programme selection knob to "Off" position. Then, you can select and start the desired programme.

### LED display

The displays will show the below information:

- Approximate time duration of a programme when selected.
- Counts down the time of a programme after it has been started: the REMAIN icon will light up to indicate the programme time is counting down.
- How long a programme has been delayed by (if selected): the DELAY icon will light up to indicate the delay time is counting down.
- Error codes (please see page 25), warning symbols (please see page 25), and if the child lock has been activated.



**ALWAYS CLEAN THE FLUFF FILTER AFTER EACH USE.** Failure to do so could cause the safety cut-out to operate.

### Reversing the Door

The door cannot be reversed.

## Installation

Your condenser tumble dryer removes humidity by using two separate air flows. Air recirculates inside the machine and is heated. Then it is passed through the damp clothes where it picks up moisture. Damp air is passed through the condenser in one direction while the room air is passed through the condenser in the other direction. This causes the moisture in the air to condense into water which is then pumped to the water tank or out through the hose.

For convenience, dryers are often positioned close to the washing machine, so the laundry can be easily transferred. The tumble dryer will expel some moist air, so make sure the room is well ventilated. Install the dryer in a clean environment, and make sure there are no obstructions around any vents. It should be placed on a firm level surface, this helps keep noise and vibration to a minimum.

For the dryer to work with less noise and vibration, it must be stable and balanced on its feet. There should be no movement from the dryer. Adjust the feet underneath the dryer to make sure it is completely stable. Rotate the feet to the right and to the left until the dryer is even and stable.

If installing the dryer under a counter you must leave 3cm of space between the side and rear walls of the product and the underside of the worktop

Do not install the tumble dryer in a room when there is a risk of frost occurring. At temperatures around freezing point the tumble dryer may not be able to operate properly. There is a risk of damage if the condensed water is allowed to freeze in the pump, hoses and condensed water container. The tumble dryer works best in a room between 5°C and 35°C.

In products equipped with a condenser unit the water accumulated during the drying cycle is collected in the water tank. For the dryer to operate at optimum efficiency the water tank should be emptied after every drying cycle. Alternatively you can directly send the accumulated water out through the water drain hose supplied with the machine instead of emptying the water tank after each drying cycle.

NOTE: when cleaning the condenser unit you will notice that an amount of water will be in the tray it has just been removed from. This is expected and normal, this is where the hot air is condensed and the water is then pumped to the water tank.

## Installation

### Connection to water drain;

1. Pull and take out the end of the hose at the back of the dryer. Do not use any tools to take out the hose.
2. Fit one end of the water discharge hose, which is provided with the product, to the slot from which you have removed the hose.
3. Fix the other end of the water discharge hose directly to the water outlet or sink. The fitting must always be secured in all types of connections. Your house may be flooded if the hose gets out of its housing during water discharge.

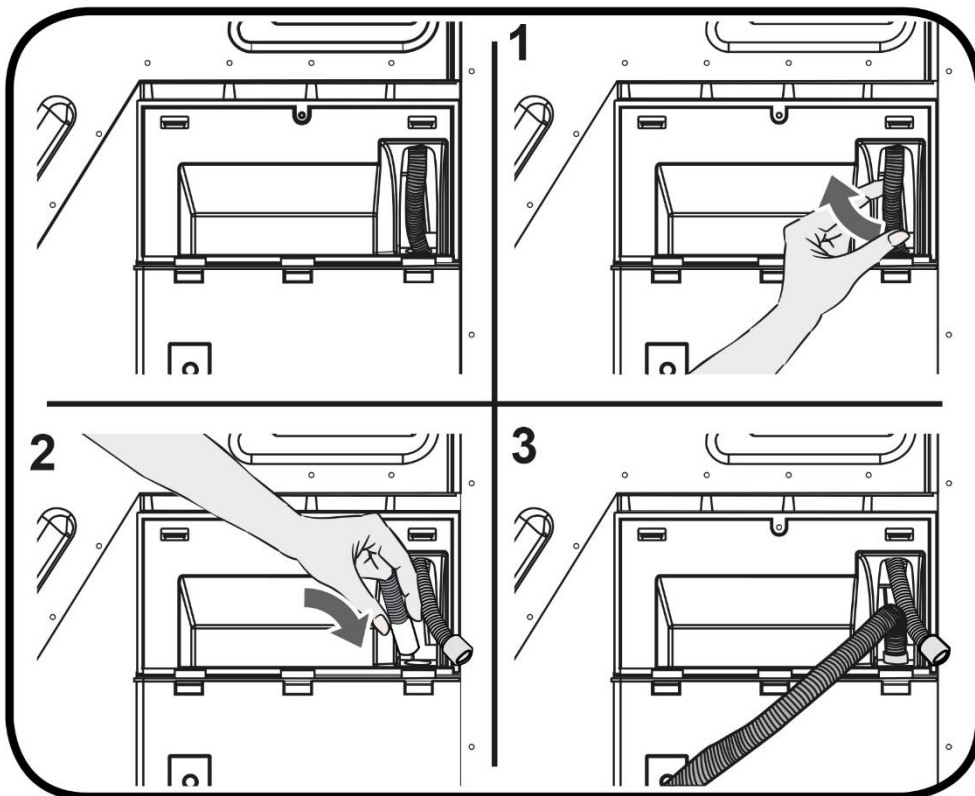

### IMPORTANT:

- The water discharge hose must be installed at a height of 80cm maximum.
- The water discharge hose must not be bent between the outlet and the product, folded or stepped over.
- You must be careful not to pinch or bend the hose.

## Operating instructions

**IMPORTANT NOTE** - If you are drying laundry that weighs less than 1kg (small loads) when wet, then select the 1hr function to dry clothes.

Remove all the packaging material, including any material inside the drum.  
Before using the appliance for the first time, it is advised to place two damp clothing articles inside the drum and dry them for 1 hour. There may be some dust in the drum of the tumble dryer, and this will help remove the dust.

### Sensor controlled drying

The appliance detects the moisture in the load automatically and adjusts the drying time according to the amount of laundry that has been loaded. Simply select a programme according to the laundry and dryness level you require (for example Cotton damp dry) and the dryer will run until the required dryness level is reached for the weight of laundry that has been put into it. This only applies to Cotton, Synthetic, Delicate and Quick programmes.

**Step 1** - Open the door and place the laundry in the drum, one item at a time. Lightly shake and loosen the clothing to prevent it getting tangled.

**IMPORTANT NOTE:** Do not overload your dryer, please see the maximum capacity of each programme in the Program Table . The following table lists some common items and their approximate weight when wet, consider this when loading the dryer. Do not overload.

Quilt cover	700g	Shirt	600g
Sheet	500g	T-shirt	200g
Pillow case	200g	Blouse	100g
tablecloth	250g	Bathrobe	1200g
Napkin	100g	Night gown	200g
Bath towel	1200g	Pyjamas	500g
Tea towel	100g	Underwear	100g

This product includes LED Drum Light. The light works automatically when you open the door and turns off when the door is closed. The light cannot be adjusted and the customer should not try to replace or modify the LED light.

## Operating instructions

**Step 2** - Close the door, ensuring no items are trapped in the door.

**Step 3** – When selecting a programme the Start/pause LED will flash. Once you have selected the required programme press the start/pause button to start the programme. The Start/pause indicator and the drying indicator will light up. The drum will begin rotating and will stop when the selected programme has finished. For the additional functions (Delicate, Dryness level, Delay Start, etc.) that can be selected with the different programmes please see page xx. Note that the additional functions have to be selected prior to the drying cycle being confirmed (they cannot be added or changed mid-cycle). Once the programme is over, the warning LEDs for Start/Pause, water tank level, filter cleaning and condenser cleaning will turn on. Additionally, an audible warning will be given at the end of the programme. You can remove the laundry to make the machine ready for a new load.

To change a programme that has already started, you have to cancel the first programme by pausing the machine and then turning the program dial to the off position, before selecting a the desired programme and pressing the Start/pause button.

If the door is opened during a cycle the dryer will stop and switch to standby mode. To restart, close the door and press the start/pause button. Do not open the door when door when a program is running, if you have to then do not keep it open for long as it will affect the drying time of the laundry.

When drying large items such as sheets, we suggest you periodically stop the dryer to redistribute the load.

















There is an automatic cool down period at the end of every cycle, during which the heater is switched off. This helps to minimize creasing, and must always be used fully to avoid the risk of fire. If the laundry is not removed at the end of the cycle the dryer will tumble the clothes every 10 minutes for up to 30 minutes to reduce the risk of the clothes creasing.

Once the programme is over, the warning LEDs for Start/Pause, water tank level, filter cleaning and condenser cleaning will turn on. Additionally, an audible warning will be given at the end of the programme. You can remove the laundry to make the machine ready for a new load.

## Operating instructions

### IMPORTANT:

- Clean the lint filter after every programme. Empty the water tank after every programme.
- If you do not take out the laundry after the programme has ended, the 1-hour Anti Crease phase will automatically be activated. This programme rotates the drum at regular intervals to prevent creases.
- Never tumble dry the following; Delicate items such as net curtains, woollen items, silk items, items with metal trims, nylon tights, bulky items such as blankets, or sleeping bags, feather quilts and items containing or including rubber foam.
- Follow the instructions on the garment label;

 Suitable for drying in a dryer	 Does not need ironing	 Sensitive/Delicate drying	 Not suitable for drying in a dryer
 No drying	 Do not dry-clean	 At any temperature	 At high temperatures
 At medium temperatures	 At low temperatures	 Heatless	 Hang to dry
 Spread to dry	 Hang wet to dry	 Spread in shadow to dry	 Suitable for dry cleaning

- To prevent some items getting tangled, make sure zips, press studs, and hooks are closed, to try and prevent any tangling with other items.
- Do not over dry laundry, by not over drying it avoids creasing and saves energy.
- Avoid drying dark clothes with light coloured fluffy items, the fluff will be noticeable on the dark clothing.
- Make sure the laundry is thoroughly spun before tumble drying.

## Program Table

Programme	Load (kg)	Spin speed	Approximate amount of remaining humidity	Duration (minutes)
Cotton Extra Dry	8	1000	60%	132
Cotton Cupboard Dry	8	1000	60%	129
Cotton Iron Dry	8	1000	60%	107
Synthetics Cupboard Dry	4	800	40%	51
Synthetics Iron Dry	4	800	40%	38
Delicate	2	600	50%	39
Time drying	-	-	-	-
Baby Care	3	1000	60%	60
Duvet	2,5	800	60%	180
Sport	4	800	40%	55
Mix	4	1000	60%	75
Wool Refresh	-	-	-	5
Refresh	-	-	-	10
Express 29'	2	1200	50%	29
Shirts 12'	0.5	1200	50%	12

### Energy consumption values

Programme	Load (kg)	Spin speed	Approximate amount of remaining humidity	Energy consumption values (kWh)
Cotton Cupboard Dry	8	1000	60%	4,68
Cotton Iron Dry	8	1000	60%	4,1
Synthetics Cupboard Dry	4	800	40%	1.58
<b>Power consumption in the "off mode" P (W)</b>				<b>0.5</b>
<b>Power consumption in the "on mode" P (W)</b>				<b>1</b>

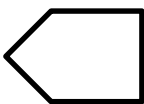

The Cotton Cupboard Dry programme is the standard drying programme that can be run with a full or half load and for which the information is given on the label and product receipt. This programme is the most energy efficient programme to dry normal wet cotton clothes.

\*Energy labelling standard programme (EN 61121:2013)

All values in the table were determined in accordance with the EN 61121:2013 standard. Consumption values may vary from the values in the table depending on the fabric type, spin speed, environment conditions and voltage values.

## Programs

Programme	Description
Cotton Extra Dry	This programme dries thick and multi-layer fabrics, such as cotton towels, bedsheets, pillowcases, bathrobes, at a high temperature to allow you to place them in a closet.
Cotton Cupboard Dry	This programme dries cotton pyjamas, underwear, tablecloths etc. to allow you to place them in a closet.
Cotton Iron Dry	This programme dries cotton laundry to prepare it for ironing. Laundry removed from the machine will be damp.
Synthetics Cupboard Dry	This programme dries synthetics, such as shirts, t-shirts, blouses, at a lower temperature compared to the cottons programme to allow you to place them in a closet.
Synthetics Iron Dry	This programme dries synthetics, such as shirts, t-shirts, blouses, at a lower temperature compared to the cottons programme to prepare them for ironing. Laundry removed from the machine will be damp.
Delicate	This programme dries thin clothes like shirts, blouses and silk garments at a low temperature to make them ready to wear.
Time Drying	To reach the required drying level at a low temperature, you can use the time programmes of 10 min. to 180 min. Regardless of the drying level, the programme stops at the desired time.
Baby Care	This programme dries delicate infant clothes at a low temperature to make them ready to wear.
Duvet	This programme is used to dry duvet.
Sport	Sport program is used for synthetic sport laundries like shorts, t-shirts at low temperature.
Mix	This programme dries cotton-synthetic mixed garments that do not discolour to make them ready to wear.
Wool Refresh	Wool refresh helps wool textiles to remove excess water after washing by applying low temperature and gentle movements of drum.
Refresh	This programme provides ventilation for 10 minutes without applying heat to help freshen up your garments.
Express 29'	2 kg of cotton shirts spun at a high speed in the washing machine are dried in 29 minutes.
Shirts 12'	2 to 3 shirts are ready for to be ironed in 12 minutes.

### **IMPORTANT:**

Do not open the loading door while the programme is running. If you have to open the door, do not keep it open for a long time.

## Additional functions

Programme	Delay Start	Buzzer Cancel	Child Lock	Delicate	Time Drying	Drying Level
Cotton Extra Dry	✓	✓	✓	✓	×	✓
Cotton Cupboard Dry	✓	✓	✓	✓	×	✓
Cotton Iron Dry	✓	✓	✓	✓	×	✓
Synthetics Cupboard Dry	✓	✓	✓	✓	×	✓
Synthetics Iron Dry	✓	✓	✓	✓	×	✓
Delicate	✓	✓	✓	✓ (default)	×	×
Time Drying	✓	✓	✓	×	✓	×
Baby Care	✓	✓	✓	✓	×	✓
Duvet	✓	✓	✓	✓ (default)	×	×
Sport	✓	✓	✓	✓	×	✓
Mix	✓	✓	✓	✓	×	✓
Wool Refresh	✓	✓	✓	×	×	×
Refresh	✓	✓	✓	×	×	×
Express 29'	✓	✓	✓	×	×	×
Shirts 12'	✓	✓	✓	×	×	×
✓	Not selectable					
×	Selectable					

### IMPORTANT:

“Delicate” and “Drying level” options cannot be selected at the same time in any programme.

## Care and maintenance

### IMPORTANT:

- Do not use industrial chemicals to clean your dryer. Do not use a dryer that has been cleaned with industrial chemicals.

### Cleaning the Fluff/lint filter

**IMPORTANT: ALWAYS CLEAN THE FILTER AFTER EACH USE.** Failure to do so could cause the safety cut-out to operate.

1. Open the door
2. Pull the filter upwards to remove it from the appliance.
3. Open the filter and remove any threads or fluff by hand or with a soft brush.
4. Close the filter and slide it back into place.

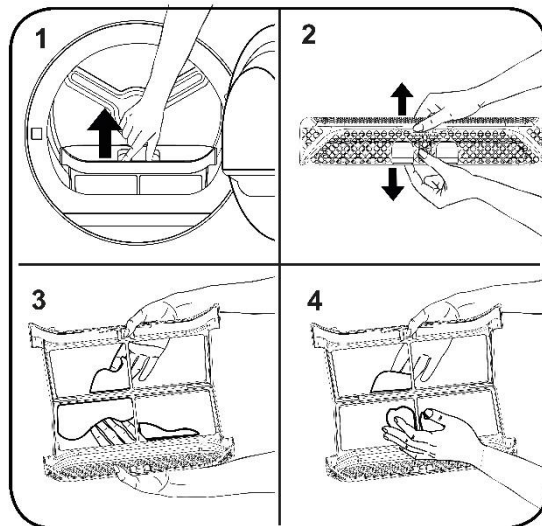

- Wash the filter occasionally in warm water or a soft brush to remove small particles. Dry the filter thoroughly before reinstalling it.



- If your filter becomes damaged, replace it to ensure no damage is caused to the dryer.

## Care and maintenance

### Emptying the water tank

#### IMPORTANT:

- Never remove the water tank when the programme is running.
- The water condensed in the water tank is not suitable for human consumption.
- **DO NOT FORGET TO EMPTY THE WATER TANK AFTER EACH USE.**

The water extraction from the wet laundry that has been dried deposits in a water tank at the top left corner of the appliance. Fully remove the water tank and empty the contents down a sink, then clean the tank and replace. For the dryer to operate at optimum efficiency the water tank should be emptied after every drying cycle

1

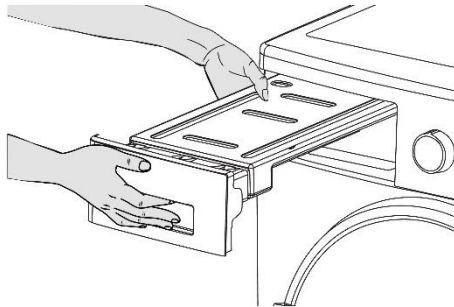

2

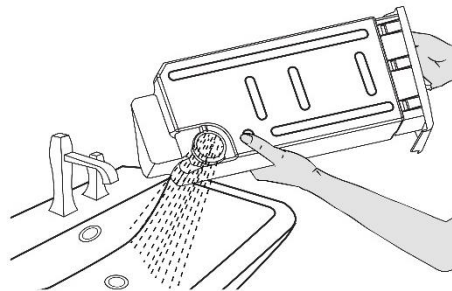

### Cleaning the condenser

#### IMPORTANT:

- Never remove the condenser when the programme is running.
- Clean the condenser when you see the warning "Condenser Cleaning".
- **EVEN IF THE "CONDENSER CLEANING WARNING LED" IS NOT ON: CLEAN THE CONDENSER AFTER EVERY 30 DRYING PROCESSES OR ONCE A MONTH.**

If the drying process is completed, open the door and wait for it to cool down.

1. Open the plinth and release the 2 cover locks of the condenser.
2. Hold the condenser by the plastic part and pull it out.
3. Clean it with a showerhead and wait for the water to drain off.
4. Fully insert the condenser into its seat and lock the 2 locks.
5. Close the plinth cover.

## Care and maintenance

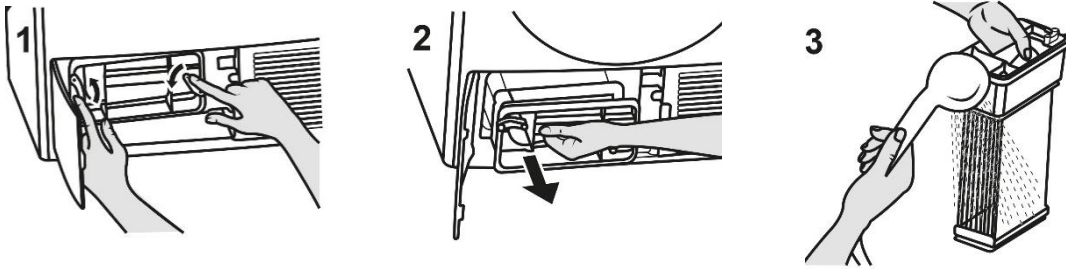

### Cleaning the Humidity Sensor

#### **IMPORTANT:**

- CLEAN THE METAL SURFACES OF THE SENSOR 4 TIMES A YEAR.
- Do not use metal tools to clean the metal surfaces of the sensor.

#### **WARNING:**

- Due to the risk of fire and explosion, do not use solution agents, cleaning agents or similar products when cleaning the sensors.

Inside the machine, there are humidity sensors that detect whether the laundry is dry or not. To clean the sensors:

1. Open the loading door of the machine.
2. If the machine is still hot due to the drying process, wait for it to cool down.
3. Using a soft cloth soaked in vinegar, wipe the metal surfaces of the sensor and dry them.

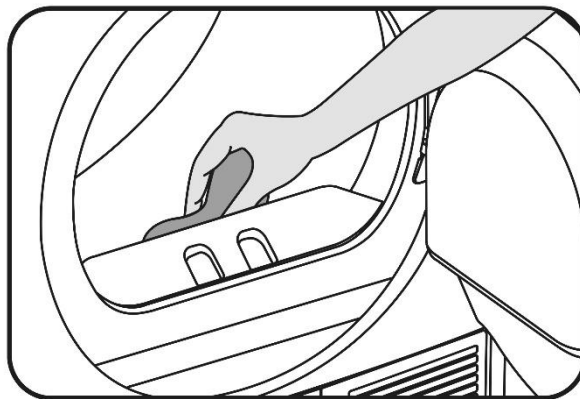

## Care and maintenance

### Cleaning the Inner Surface of door

#### **IMPORTANT:**

- **DO NOT FORGET TO CLEAN THE INNER SURFACE OF THE LOADING DOOR AFTER EACH DRYING PROCESS.**

Open the loading door of the dryer and clean all of the inner surfaces and the gasket with a soft, damp cloth.

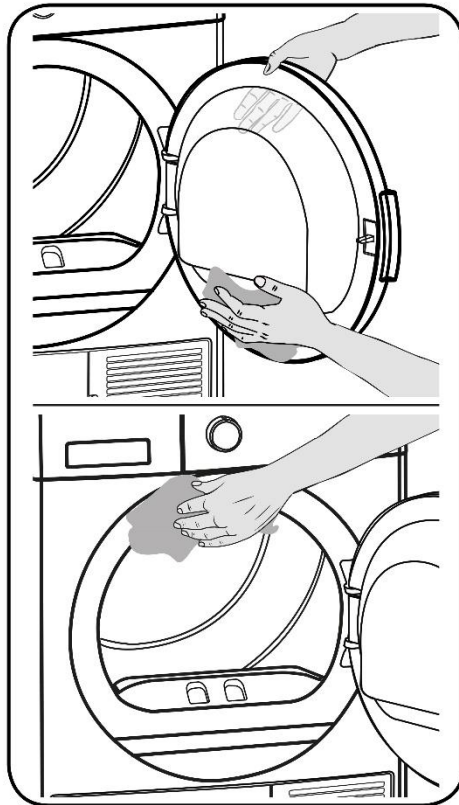

## Trouble shooting

Your dryer is fitted with systems that continuously perform checks during the drying process to take the necessary measures and warn you in case of any malfunction.

### WARNING:

- If the problem persists even if you have applied the steps in this section, please contact the your dealer or an Authorised Service Provider. Never try to repair a non-functional product.

PROBLEM	REASON	SOLUTION
The drying process takes a long time.	The surface of the fluff/lint filter might be clogged.	Wash the filter with lukewarm water.
	The condenser might be clogged.	Clean the condenser.
	The ventilation grills in front of the machine might be closed.	Open the doors/windows to prevent the room temperature from rising too much.
	There might be a layer of limescale on the humidity sensor.	Clean the humidity sensor.
	The dryer might be overloaded with laundry.	Do not overload the dryer.
	The laundry might be insufficiently spun.	Select a higher spin speed on your washing machine.
Laundry comes out damp at the end of the drying process.	<b>WARNING!</b> The laundry that comes out hot at the end of the drying process generally feels more humid.	
	The programme used might not be suitable for the type of laundry	Check the care labels on the laundry items, select a suitable programme for the type of laundry and additionally, use the time programmes.
	The surface of the lint filter might be clogged.	Wash the filter with lukewarm water.
	The condenser might be clogged.	Clean the condenser.
	The dryer might be overloaded with laundry.	Do not overload the dryer.
	The laundry might be insufficiently spun.	Select a higher spin speed on your washing machine.
The dryer cannot be opened or the programme cannot be started. The dryer does not get activated when adjusted	The dryer might not be plugged in.	Make sure that the plug is fitted in the socket.

## Trouble shooting

PROBLEM	REASON	SOLUTION
The dryer cannot be opened or the programme cannot be started. The dryer does not get activated when adjusted	The dryer might not be plugged in.	Make sure that the plug is fitted in the socket.
	The loading door might be open.	Make sure that the loading door is properly closed.
	You might not have set a programme or pressed the Start/ Pause key.	Make sure that the programme has been set and the dryer is not in the Standby (Pause) mode.
	Child lock might be active.	Deactivate the child lock.
The programme has been interrupted for no reason.	The loading door might not be closed properly.	Make sure that the loading door is properly closed.
	There might have been a power failure.	Press the Start/Pause key to start the programme.
	The water tank might be full.	Empty the water tank.
Clothes have shrunk, felted or deteriorated.	The programme used might not be suitable for the type of laundry.	Check the care labels on the laundry items, select a suitable programme for the type of laundry.
Water leaking from the loading door.	There might be lint accumulated on the inner surfaces of the loading door and on the surfaces of the gasket of the loading door.	Clean the inner surfaces of the loading door and the surfaces of the gasket of the loading door.
The loading door opens on its own.	The loading door might not be closed properly.	Push the loading door until you hear the closing sound.
The water tank warning symbol is on/flashing.	The water tank might be full.	Empty the water tank.
	The water discharge hose might be bent.	If the product is connected directly to the water outlet, check the water discharge hose.
The filter cleaning warning symbol is on.	The lint filter might be unclean.	Clean the filter.
The condenser cleaning warning symbol is on.	The condenser might be unclean.	Clean the condenser.
The filter cleaning and condenser warning symbol are flashing.	The filter seat might be clogged by lint.	Clean the filter seat.
	There might be a layer that causes obstruction on the surface of the lint filter.	Wash the filter with lukewarm water.
	The condenser might be clogged.	Clean the condenser.

## Warnings symbols

WARNING SYMBOL	REASON	SOLUTION
The water tank warning symbol is on/flashing.	The water tank might be full.	Empty the water tank.
	The water discharge hose might be bent.	If the product is connected directly to the water outlet, check the water discharge hose.
The filter cleaning warning symbol is on.	The lint filter might be unclean.	Clean the filter.
The condenser cleaning warning symbol is on.	The condenser might be unclean.	Clean the condenser.
The filter cleaning and condenser warning symbol are flashing.	The filter seat might be clogged by lint.	Clean the filter seat.
	There might be a layer that causes obstruction on the surface of the lint filter.	Wash the filter with lukewarm water.
	The condenser might be clogged.	Clean the condenser.

## Error codes

ERROR CODE	FAULT	SOLUTION
E00	Problem with the PCB	Contact customer service
E03 / 	Water tank is full	Empty the water tank, if problem isn't solved, contact customer service
E04	Problem with the heater	Contact customer service
E05	Problem with the heater	Contact customer service
E06	Problem with the door	Contact customer service
E08	Problem with the electricity supply	There may be voltage fluctuation in the mains. Wait until voltage is appropriate for the working range.

## Technical specification

Brand	Russell Hobbs
Model	RH8CTD701 (B)
Type of dryer	Condenser
Energy efficiency rating	B
Capacity (kg)	8
Dimensions (CMs)	(H)85.5 x (W)59.6 x (D)60.9
Voltage (V)	220 – 240 V
Power (W)	2700 W

## Energy Efficiency

- You should operate the dryer to full capacity, but make sure that it is not overloaded.
- When the laundry is being washed, the spin speed should be at the highest level possible. This will shorten the drying time and reduce energy consumption.
- Make sure that the same kinds of laundry are dried together.
- Please follow the recommendations in the user manual for programme selection.
- For air circulation, leave an appropriate clearance on the front and back sides of the Dryer. Do not cover the grills on the front side of the machine.
- Unless necessary, do not open the door of the machine when drying. If you have to open it, do not keep it open for a long time.
- Do not add new (wet) laundry during the drying process.
- Hairs and lint that detach from the laundry and merge in the air are collected by the "Lint Filters". Please make sure that the filters are cleaned before and after each use.
- For models with a condenser, make sure that the condenser is cleaned at least once a month or after each 30 uses.
- During the drying process, the environment where the dryer is installed must be well ventilated.

## Product fiche

PRODUCT FICHE	
Complying Commission Delegated Regulation (EU) No 392/2012	
Supplier name or trademark	Russell Hobbs
Model name	RH8CTD701
Rated capacity (kg)	8
Type of Tumble Dryer	Condenser
Energy efficiency class (1)	B
Annual Energy Consumption (kWh) (2)	561
Automatic or Non-automatic	Automatic
Energy Consumption of the standard cotton programme at full load (kWh)	4,68
Energy Consumption of the standard cotton programme at partial load (kWh)	2,56
Power consumption of the off-mode for the standard cotton programme at full load P <sub>o</sub> (W)	0,5
Power consumption of the left-on mode for the standard cotton programme at full load P <sub>L</sub> (W)	1,0
The duration of the left mode on (min)	n/a
Standard cotton programme (3)	
Programme time of the standard cotton programme at full load, T <sub>dry</sub> (min.)	129
Programme time of the standard cotton programme at partial load, T <sub>dry 1/2</sub> (min.)	76
Weighted programme time of the standard cotton programme at full and partial load (T <sub>t</sub> )	99
Condensation efficiency class (4)	B
Average condensation efficiency of the standard cotton programme at full load C <sub>dry</sub>	81%
Average condensation efficiency of the standard cotton programme at partial load C <sub>dry1/2</sub>	81%
Weighted condensation efficiency of the standard cotton programme at full load and partial load C <sub>t</sub>	81%
Sound power level for the standard cotton programme at full load (5)	65
Built-in	No

1. Scale from A+++ (most efficient) to D (least efficient)
2. Energy consumption based on 160 drying cycles of the standard cotton programme at full and partial load, and the consumption of the low-power modes. Actual energy consumption per cycle will depend on how the appliance is used.
3. "Cotton cupboard dry programme" used at full and partial load is the standard drying programme to which the information in the label and the fiche relates, that this programme is suitable for drying normal wet cotton laundry and that it is the most efficient programme in terms of energy consumption for cotton
4. Scale from G (least efficient) to A (most efficient)
5. Weighted average value - L<sub>wA</sub> expressed in dB(A) re 1 pW

## Connections to the mains supply

### **WARNING-** THIS APPLIANCE MUST BE EARTHED

This appliance is designed to operate from a mains supply of AC230V ~ 50HZ.  
Check that the voltage marked on the product corresponds with your supply voltage.

This product is fitted with a 13A plug complying with BS1363.

If this plug is unsuitable or needs to be replaced, please note the following:

Important: The wires in the mains lead are  
Coloured in accordance with the following code:  
GREEN/YELLOW - EARTH  
BLUE - NEUTRAL  
BROWN - LIVE



For UK use only – Plug fitting details (where applicable):

As the colours of the wires in the mains lead of this appliance may not correspond with the coloured markings identifying the terminals in your plug, proceed as follows:

The GREEN/YELLOW wire is the EARTH and must be connected to the terminal which is marked with the letter E or by the earth symbol or coloured GREEN or GREEN/YELLOW.

The BLUE wire is the NEUTRAL and must be connected to the terminal marked with the letter N or coloured BLACK.

The BROWN wire is the LIVE wire and must be connected to the terminal marked with the letter L or coloured RED.

Always ensure that the plug cord grip is fastened correctly.

If a 13A (BS1363) fused plug is used it must be fitted with a 13amp fuse conforming to BS1362 and be BSI or ASTA approved.

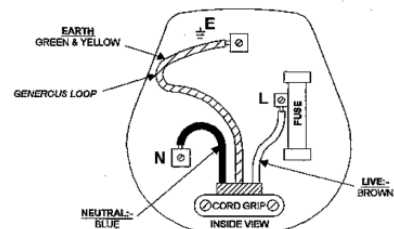

## **Guarantee**

This product is guaranteed for 12 months from the date of the original purchase. If any defect arises due to faulty materials or workmanship the faulty product must be returned to the place of purchase.

Refund or replacement is at the discretion of the retailer.

### **The following conditions apply:**

- The product must be returned to the retailer with the original proof of purchase.
- The product must be installed and used in accordance with the instructions contained in this instruction guide and any other instructions for use which are supplied.
- It must be used for domestic purposes only and for its intended use.
- This warranty does not cover wear and tear, damage, misuse or consumable parts.

**This does not affect your statutory rights.**

Produced for:

**G2S Limited,**

**Wigan,**

**WN2 4AY**

**Notes**

For Customer Services & Spare  
Parts please call  
**0345 208 8750**  
or visit us at  
**<https://mda.russellhobbs.com>**



This symbol is known as the 'Crossed-out wheellie bin Symbol'. When this symbol is marked on a product/batteries, it means that the product/batteries should not be disposed of with your general household waste. Only discard electrical/electronic/battery items in separate collection schemes, which cater for the recovery and recycling of materials contained within. Your co-operation is vital to make sure the success of these schemes and for the protection of the environment. For your nearest disposal facility, visit [www.recycle-more.co.uk](http://www.recycle-more.co.uk) or ask in store for details.

We reserve the right due to possible changes to design to alter the instruction manual without prior notice.

 **Russell Hobbs**  
Revision 1