

This Owner's Manual is provided and hosted by [Appliance Factory Parts](#).



Russell Hobbs RHEP7 Owner's Manual

[Shop genuine replacement parts for Russell Hobbs RHEP7](#)



[Find Your Russell Hobbs Pressure Cooker Parts - Select From 5 Models](#)

----- Manual continues below -----



Russell Hobbs

INSTRUCTIONS AND WARRANTY



MODEL NO. RHEP7

RUSSELL HOBBS 6L ELECTRIC PRESSURE COOKER

Congratulations on purchasing our Russell Hobbs 6L Electric Pressure Cooker. Each unit is manufactured to ensure safety and reliability. Before using this appliance for the first time, please read the instruction manual carefully and keep it for future reference.

FEATURES OF THE RUSSELL HOBBS 6L ELECTRIC PRESSURE COOKER

- 1000W
- 16 multi-function menus: meat, poultry, vegetables, steam, saute, slow cook, white rice, brown rice, beans, broth, curry, soup, multigrain, congee, chili and manual settings
- Reheat and keep-warm modes
- Easy-to-use, touch-button settings
- Perfect for stews, soups, meats, chicken, fish, beans and rice
- 90 min countdown timer with digital LED display
- Featuring 9 advanced structural and technical safety features
- Cool touch handles on top and sides
- No mess, no fuss water collector
- Non-stick removable 6L cooking pot for easy cleaning – dishwasher safe
- Convenient water level indicator inside cooking pot
- Finger-print proof with elegant black and stainless steel construction
- Preserves nutrients and promotes healthier eating
- Cooking under 106-114°C high temperature. Eliminates bacteria in food whilst preserving nutrients and great taste.
- Energy efficient - up to 70% faster than traditional cooking methods
- Preset timer function– up to 24h delay
- Includes measuring cup, spoon and rack
- Size of Inner Pot: 8.66”/ 21.99cm/ 219.9mm
- Working pressure: 70kPa
- Keep warm temperature: 140°C
- Product size: 310 x 305 x 320mm
- For domestic use only
- 1 year warranty

IMPORTANT SAFEGUARDS

When using any electrical appliance, basic safety precautions should always be followed including the following:

1. Please read the instructions carefully before using any appliance.
2. Always ensure that the voltage on the rating label corresponds to the mains voltage in your home.
3. Incorrect operation and improper use can damage the appliance and cause injury to the user.
4. The appliance is intended for household use only. Commercial use invalids the warranty and the supplier cannot be held responsible for injury or damage caused when using the appliance for any other purpose than that intended.
5. Avoid any contact with moving parts.
6. This appliance is not intended for use by persons (including children) with reduced physical, sensory or mental capabilities, or lack of experience and knowledge, unless they have been given supervision or instruction concerning use of the appliance by a person responsible for their safety.
7. Children should be supervised to ensure that they do not play with the appliance.
8. Check the power cord and plug regularly for any damage. If the cord or the plug is damaged, the manufacturer or a qualified person must replace it in order to avoid an electrical hazard.
9. Do not touch hot surfaces – use handles.
10. Use oven mitts/ protective gloves when removing the Inner Pot.
11. Always lift the lid away from your face as escaping steam may cause injury or scalding.
12. Keep hands, arms, face etc clear from the escaping steam when opening the lid or moving dishes.
13. Whilst the appliance is in operation and whilst it is cooling off after the cooking cycle has completed - be careful not to touch the lid in order to avoid scalding and injury. If you must do so, please use an oven mitt or protective glove.
14. Do not cover the pressure cooker when in use.
15. Make certain that the unit is properly closed before operating. See “Operating Instructions”.
16. Do not fill the unit over 2/3 full. When cooking foods that expand during cooking such as rice or dried vegetables, do not fill the unit over 1/2 full. Over-filling may cause a risk of clogging the float valve and developing excess pressure. Failure to follow this procedure can result in injury to person(s) and/or damage to the unit.
17. Be aware that certain foods, such as apple sauce, cranberries, pearl barley, oatmeal or other cereals, split peas, noodles, macaroni, rhubarb, or spaghetti can foam, froth, and

- splutter, and clog the pressure release device (steam vent). These foods should not be cooked in a pressure cooker.
18. Always check the pressure release devices for clogging before use.
 19. To cook dry foods, please soak them in water for a period before cooking.
 20. The maximum cooking amount should not exceed the Max (maximum) mark as indicated on the Inner Pot.
 21. Do not move the pressure cooker when it is pressurized.
 22. Do not open the pressure cooker until the unit has cooled and all internal pressure has been released. If the handles are difficult to push apart, this indicates that the cooker is still pressurized – do not force it open. Any pressure in the cooker can be hazardous. See “Operating Instructions”.
 23. Do not use the pressure cooker for pressure frying with oil.
 24. Do not use the pressure cooker near explosive objects. Do not place the pressure cooker in direct sunlight.
 25. DO NOT place the appliance near flammable materials or use in a humid environment.
 26. Check that the Block Proof Cover, Float Valve and Exhaust Valve are not jammed before each use; wipe the external surface of the Inner Pot and the Heating Plate, remove foreign objects from it; ensure that the Exhaust Valve remains fitted to the lid correctly.
 27. DO NOT damage the seal ring and DO NOT replace it with anything other than the replacement ring designed especially for this unit.
 28. DO NOT tamper with the seal ring bracket in the lid with any tools or external forces. If the seal ring bracket is damaged, please stop using immediately and replace the lid.
 29. Clean the block proof cover regularly to keep the cooker clean and ensure proper operation.
 30. NEVER use additional weight on the exhaust valve/ exhaust valve handle or replace them with anything not intended for use with this unit.
 31. The surface of contact between the inner pot and the electronic heater inside the main cooker body should always be clean. DO NOT use the inner pot with other heating sources. DO NOT replace the inner pot with a container other than what is recommended by the manufacturer.
 32. The inner pot showcases a non-stick layer surface. To avoid scratching the non-stick surface, please use wooden or plastic utensils.
 33. Food should not be kept warm for more than 4-6 hours in order to maintain the continued freshness of the food. The pressure cooker should not be used for more than 6 hours continuously. Serious Injury and/or damage may occur if any safeguards are ignored.
 34. If steam releases around the lid during the cooking process, please unplug from the power supply immediately, let cool, remove contents and return the product to the manufacturer for exchange or repair. The Pressure Discharging Device has activated. This is a safeguard to alert the user that the Pressure Limiting Device is malfunctioning.

35. Let the pressure cooker cool down completely before you clean it or put it away.
36. Extreme caution must be used when moving a pressure cooker containing hot liquids. It is recommended that you do not move the appliance when it is full, when switched on or before it has cooled down.
37. Do not use the appliance if it has been dropped or damaged in any way. In case of damage, take the unit in for examination and/or repair by an authorised service agent.
38. To reduce the risk of electric shock, do not immerse or expose the appliance, plug or the power cord to water or any other liquid.
39. Never immerse the unit in water or any other liquid for cleaning purposes.
40. This appliance cooks under pressure. Improper use may result in injury.
41. Remove the plug from the socket by gripping the plug. Do not pull on the cord to disconnect the appliance from the mains. Always unplug the unit when not in use, before cleaning or when adding or removing parts.
42. The use of accessory attachments/ parts that are not recommended or supplied by the manufacturer may result in injuries, fire or electric shock.
43. A short detachable cord is provided to reduce the hazards resulting from becoming entangled in or tripping over a longer cord.
44. Do not let the cord hang over the edge of a table or counter. Ensure that the cord is not in a position where it can be pulled on inadvertently.
45. Do not allow the cord to touch hot surfaces and do not place on or near a hot gas or electric burner or in a heated oven.
46. Do not use the appliance on a gas or electric cooking top or over or near an open flame.
47. Do not use or place the Inner Pot on another appliance to heat or cook. This may cause deformation or faults with the Inner Pot and prohibit the correct working condition/ performance of the Electric Pressure Cooker.
48. Use of an extension cord with the appliance is not recommended. However, if it is necessary to use an extension lead, ensure that the lead is suited to the power consumption of the appliance to avoid overheating of the extension cord, appliance or plug point. Do not place the extension cord in a position where it can be pulled on by children or animals, or tripped over.
49. This appliance is not suitable for outdoor use. For household use only. Do not use this appliance for anything other than its intended use.
50. DO NOT carry the appliance by the power cord.
51. Do not operate this appliance by means of an external timer or remote control system.
52. Do not leave the appliance unattended during use. Always unplug the unit when not in use or before cleaning.
53. Always operate the appliance on a smooth, even, stable surface. Do not place the unit on a hot surface.
54. Ensure that the switch is in the "Off" position after each use.

55. The manufacturer does not accept responsibility for any damage or injury caused by improper or incorrect use, or for repairs carried out by unauthorised personnel.
56. In case of technical problems, switch off the machine and do not attempt to repair it yourself. Return the appliance to an authorised service facility for examination, adjustment or repair. Always insist on the use of original spare parts. Failure to comply with the above mentioned pre-cautions and instructions, could affect the safe operation of this machine.

ABOUT YOUR PRESSURE COOKER

This digitally controlled and automatic electric pressure cooker uses advanced technology so that you and your family can enjoy the benefits of better, faster and healthier cooking. Your Pro-Cook Pressure Cooker seals in steam to cook hotter and faster while maintaining important nutrients for healthier meals. Cook fast and with less water to save vital natural resources and energy. It features easy touch-button settings, a countdown timer, and a very large cooking pot which is large enough for family gatherings! It's the easiest pressure cooker to use on the market. It may seem like a complicated unit but rest assured, this pressure cooker is simple to use, makes meals quick and easy, and overall it saves you money! Please accept our thanks for purchasing a Pro-Cook Pressure Cooker and Enjoy!

RAPID COOKING, TIME & POWER SAVING

By using high pressure (high temperature) to cook, food will be rapidly cooked. This in turn reduces the amount of time it takes to cook as well as consumption of power. For example: when cooking rice, this pressure cooker will save up to 20% of the electricity and up to 15% of the time when compared to a conventional rice cooker. When cooking stew, soups or braising meats, this cooker will save more than 40% of time and more than 45% of power as compared to a conventional slow cooker. Cooking can also be done at high altitudes.

PRESERVE NUTRIENTS & PROMOTE HEALTHIER EATING

- Airtight cooking methods preserve nutrients and original flavour of food.
- Cooking under 106°C to 114°C high temperatures means that all bacteria in the food will be eliminated and the nutrients and tastiness of the food will be preserved.
- A clean environment and work surface can be maintained as any overflow can be avoided. Steam will not escape from this cooker when it is used for simmering and for making stew.

ADVANCED STRUCTURAL DESIGN, SAFETY ENSURED

1. Lid Safety Guard:

The lid will detect if there is pressure inside the cooker. If it detects a high level of pressure then the lid will lock and prevent opening.

2. Micro Switch:

If the lid is not properly secured, a micro switch on the pressure cooker will detect this and prevent the cooker from working.

3. Pressure Switch:

Should the inner pressure become higher than that of the preset pressure value then the pressure switch will activate so as to stop the unit from heating. Heating will then be restored when the pressure decreases and is below the preset pressure value.

4. Pressure Limiting Device:

Should the pressure controlling device malfunction and approaches the maximum allowed pressure threshold then the pressure limiting valve will release steam in the cooker to maintain the correct pressure allowed.

5. Pressure Discharging Device:

Should the Pressure Limiting Device malfunction then the pressure in the cooker will rise until the maximum allowable threshold. In this instance, the Pressure Discharging Device will function and begin to discharge the pressurised steam from around the lid.

6. Temperature Limiting Device:

If the cooker is empty or reaching a threshold temperature then the Temperature Limiting Device will automatically turn off the power supply.

7. Threshold Temperature Safety Device:

Should the cooker's inner temperature reach the maximum allowable threshold temperature then the power supply will automatically be turned off.

8. Anti-blockage Valve Filter:

The Anti-blockage Valve Filter helps to prevent the pressure limiting valve from clogging.

9. Over Current Protection:

Should the electrical current proceed over the accepted range causing the appliance to burn out, the Over Current Protection facility will turn off the power supply.

PARTS DIAGRAM OF THE PRESSURE COOKER

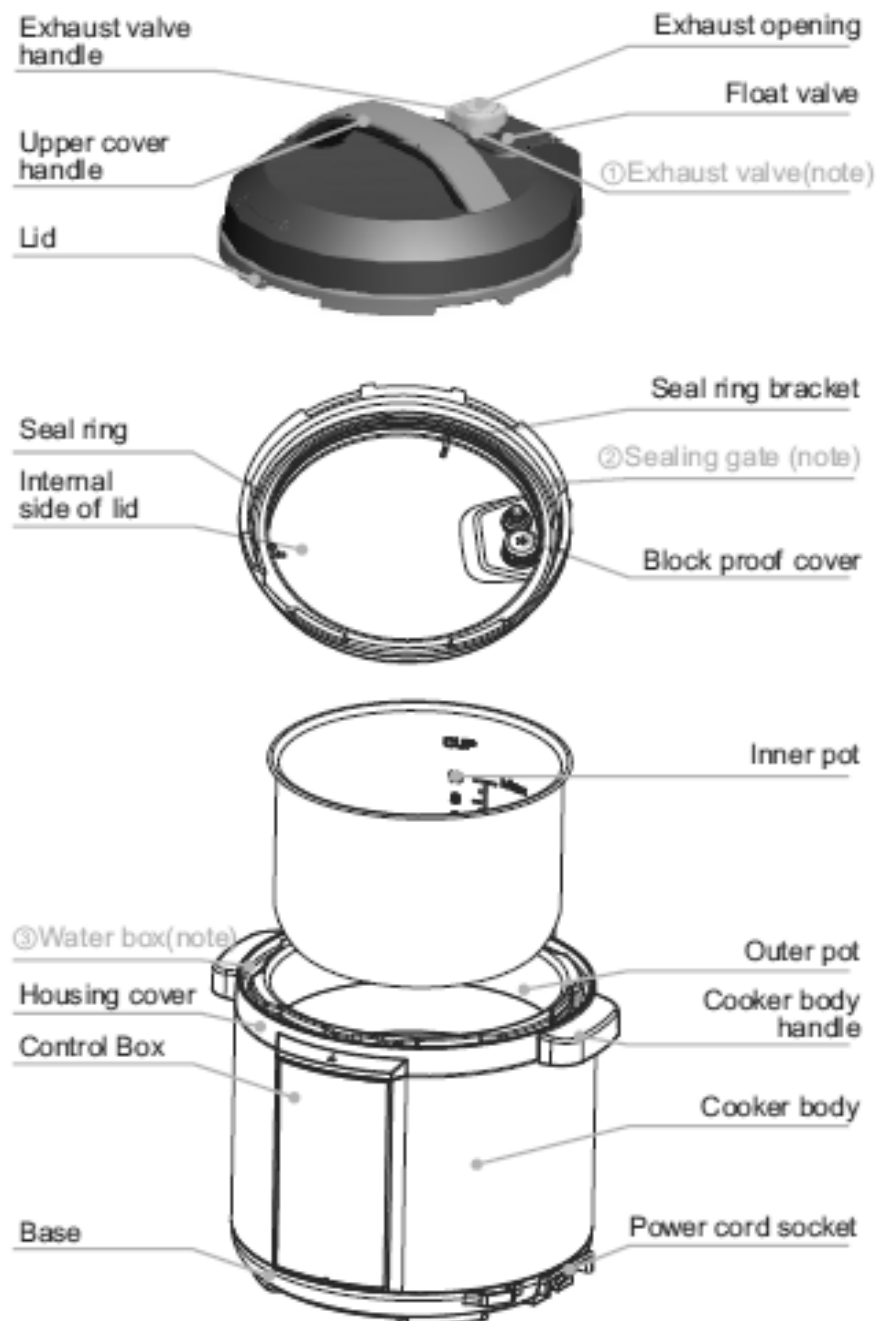

Note:

- ① Exhaust Valve: Pull the Exhaust Valve out from the lid. Clean the internal side of the Exhaust Valve. Clean the Exhaust Valve and Float Valve with a brush and cloth at least once a month.
- ② Sealing Gate: Please remove any oil and dirt from the Sealing Gate with mild detergent and a brush. Any remaining oil and dirt in it may appear yellowish in colour. After cleaning, it may recover to the original stainless steel colour. It is suggested to clean the Sealing Gate once every 2 (two) months.
- ③ Water Box: After cooking, steam/ water may remain in the Water Box of the External Pot. Water in the box should be cleaned and removed to maintain hygiene and cleanliness.

STRUCTURAL DIAGRAM OF THE FLOAT VALVE

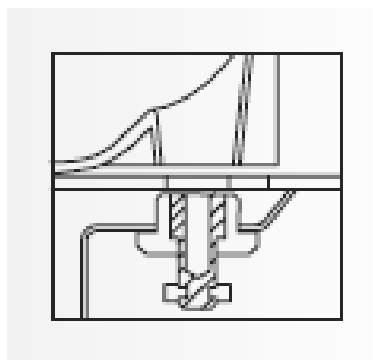

Check to ensure that the Float Valve, Block Proof Cover and Seal Ring are correctly installed before each use. Before placing the Inner Pot back into the Pressure Cooker, please remove any dirt and water from the outer side of the Inner Pot and inside (internal sides) of the External Pot.

CONTROL PANEL



BEFORE FIRST USE

Before using this unit, please read these instructions completely. Save this manual and pass it on to next user.

Before using this appliance for the first time, unpack the appliance and remove all protective packaging and wrappings. Please ensure to discard the protective packaging and wrappings immediately. It is important to keep these away from babies, infants and children for safety purposes.

Follow all cleaning instructions and dry thoroughly.

DISASSEMBLY AND INSTALLATION OF THE BLOCK PROOF COVER AND SEAL RING

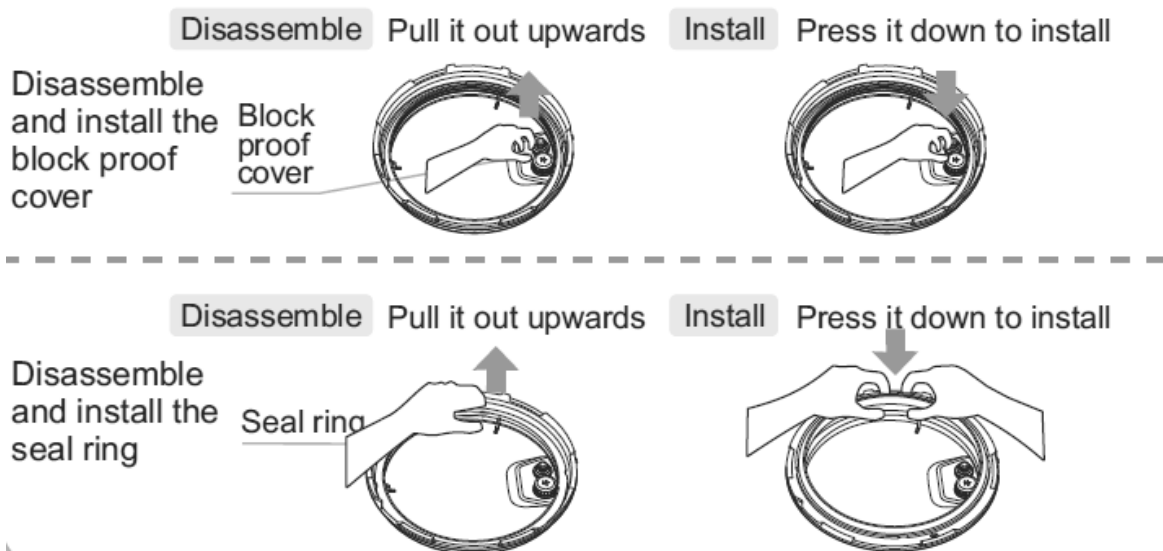

Note in the Disassembly and Installation of the Block Proof Cover:

1. Check that the Seal Ring and Block Proof Cover are correctly installed in the lid before each use.

2. After use, please clean the Seal Ring and around of Block Proof Cover to avoid possible jamming. Please do keep it clean to maintain hygiene/ cleanliness and to avoid a bad odour.

Note in the Disassembly and Installation of the Seal Ring:

1. Please do not pull the Seal Ring as a distorted Seal Ring may influence the performance of the appliance and the amount of pressure generated.
2. Do not use a damaged Seal Ring, please replace it at a authorized Home of Living Brands (PTY) Ltd service centre/ repair agent.

PREPARE FOR COOKING

Opening the lid correctly. Hold the handle of lid, turn it anticlockwise until the “DOWN ARROW” mark on the edge of the lid matches up with the “UP ARROW” mark on the edge of the housing cover. Now lift the lid to open. Note: For new pressure cookers, the seal of the lid may be slightly stronger than normal and may be slightly difficult to unlock. Once the lid has been opened and closed several times, it will loosen up.

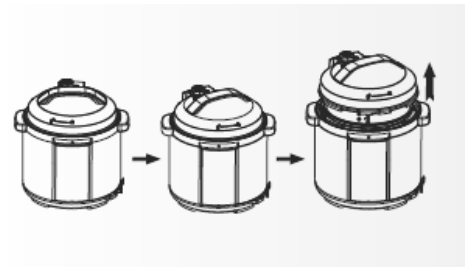

Check that the parts of the lid are assembled correctly. Check that the Float Valve and the Exhaust Valve are not jammed. Confirm that the Sealing Ring and Block Proof Cover are assembled correctly.

Remove the Inner Pot and place foods and water into the Inner Pot. Note that the total amount of food and water should not exceed the Max mark on the Inner Pot. The maximum amount of rice and water when cooking should not exceed the Max mark on the Inner Pot.



Place the Inner Pot into the Pressure Cooker.

Wipe the external surface of the Inner Pot clean. Foreign objects and water are not allowed inside the actual pressure cooker. Turn the Inner Pot to the left and right to ensure good contact with the heating plate.



Safely close the lid. Before closing the lid, check That the Sealing Ring is assembled and placed correctly. Hold the handle of lid, aim the “DOWN ARROW” mark on the edge of the lid so that it is aligned/ matched with the “UP ARROW” mark on the edge of the housing cover. Place the lid horizontally on to the pressure cooker, turn the lid clockwise in order to lock into place. You will notice that the “UP ARROW” mark on the edge of the housing cover matches up/ aligns with the “LOCK” mark on the lid.

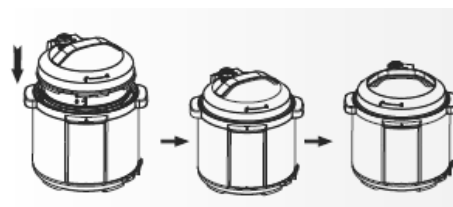

Position the Exhaust Valve Correctly.

Please note that the exhaust valve will be loose when you are not using the unit for cooking. It will rock slightly and will turn 360° manually. Once the cooker is in operation and the pressure has built up to its capacity, the exhaust valve will tighten securely, only allowing itself to be turned in order to release/ exhaust steam. Once all the pressure has released, it will become loose again.

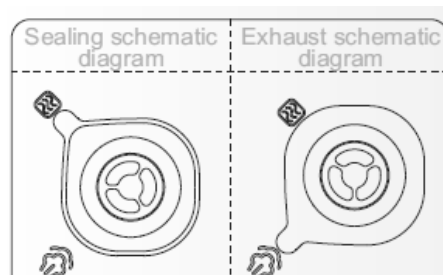

During operation, turn the Exhaust Valve to the seal position. In doing so, it means that the Pressure Cooker will remain sealed and maintain pressure. For manual/ quick exhaust, turn the exhaust valve handle to the exhaust position. This will ensure that the pressure cooker will exhaust steam and pressure. Note: do not place

hands, face or arms above the exhaust opening during the exhaust process. Check that the float valve drops down before operating. Note that the float valve should be down before the appliance starts to heat.

GENERAL FUNCTION SELECTION

- Switch the appliance on. If the buttons are inactive, check that the lid is closed and in the correct position. The buttons will be inactive if the lid is not closed correctly.
- Select the required function. In standby mode, press the "Menu" button to select the required function. Press the "+" / "-" button to select the required cooking time. Each menu function will require a different cooking time. Note that the more food in the pot, the longer the cooker time required.
- Once selected, 10 seconds later, the electric pressure cooker will start the selected menu function/ program and start working/ cooking. During this time, you may press the "Keep Warm/ OFF" button to cancel the current menu function/ program, end the cooking cycle, and return to standby mode.
- Should the menu function/ program run its course and finish the cooking cycle, the pressure cooker will automatically switch over into Keep Warm mode. The Keep Warm mode should not exceed 2 (two) hours. After cooking, the indicator light of the corresponding function will turn off. The Keep Warm indicator light will glow and the pressure cooker will make a "beep" sound as the cooker switches over to this mode.
- In standby mode, press the "Keep Warm/OFF" button to active the Keep Warm mode. In doing so, the keep warm indicator lights will glow.

QUANTITY OF WATER TO BE USED

The amount of water should not exceed 4/5 of the height of the inner pot. For food that will expand in water, the level should not exceed 3/5 of the inner pot. The minimum level for cooking would be 1/5 of the inner pot.

When cooking rice, the maximum amount of rice allowed for this pressure cooker is 4 cups of uncooked white rice. Normally one cup of rice requires one cup of water. This may vary according to taste.

THE WATER COLLECTOR/ BOX

The water collector is included is included in the accessory bag provided. The water collector should be attached to the pressure cooker. The purpose of the water collector is to collect the steam which drips off/ runs/ overflows from the inner pot as you open the lid after the cooking cycle. It is easy to clean by simply detaching it from the side of the cooker.

SAFELY OPENING THE LID

- Turn the appliance off and remove the plug from the power outlet located at the wall.
- Utilize your chosen exhaust method.
- Once the appliance has exhausted all pressure. You may open the lid.
- Turn the lid anticlockwise, lift the lid up and off from the main pressure cooker body.

Note:

- Do not open the lid before the pressure in the pot has been completely released/ exhausted. Do not open the lid if it feels difficult to open.
- Do not pull the Exhaust Valve out when turning the exhaust valve.
- After cooking liquid-orientated foods (for example, porridge or soup), do not turn the Exhaust Valve. Turn the appliance off and remove the plug from the power outlet. Allow the appliance to cool naturally until the Float Valve drops before opening the lid.
- After cooking a large amount of food, please do not immediately exhaust. We suggest that that you allow the unit to switch over to the Keep Warm function/ mode for a few minutes before opening the lid.

MULTI-FUNCTION MENU

Standby Mode

After supplying power, the default is standby state, the digital screen flashes “----”

Meat Setting

Normal Cooking:

- In standby mode, press the “Menu” button.
- The “” indicator light will turn on.
- The LED display will flash “P01”.
- 10 (ten) seconds later if no button is pressed, the appliance will automatically start cooking using the “Meat” setting/ mode.
- The LED display will show “P01” and start to countdown when pressure rises in the cooker.

Preset Cooking:

- In standby mode, press the “Menu” button.
- The “” indicator light will turn on.
- The LED display will flash “P01”.
- Press the “Delay Timer” button. The “Delay Timer” indicator will begin to flash. The LED display will flash the amount of preset time.
- Adjust the amount of preset time by pressing the “+”/“-” buttons. Each adjustment will adjust the amount of preset time by 10 (ten) minutes.
- 10 (ten) seconds after setting the preset time, the appliance will automatically start preset cooking using the “Meat” setting. The LED display will show the cooking cycle finishing time and start to countdown.

To Exit the Cooking Cycle/ Mode:

- Press the “Keep Warm” button to exit the current cooking cycle/ mode.

CAUTION: It is not recommended to use the Preset function to cook foods which may spoil quickly. Leaving raw foods inside the pressure cooker for long periods of time prior to cooking may result in the food spoiling. Cook food that can be left out such as rice, beans, grains or other similar foods which will not spoil easily.

Poultry Setting

Normal Cooking:

- In standby mode, press the “Menu” button.
- The “” indicator light will turn on.
- The LED display will flash “P01”.
- Now press the “+” button once.
- The LED display will show “P02”.
- 10 (ten) seconds later if no button is pressed, the appliance will automatically start cooking using the “Poultry” setting/ mode.
- The LED display will show “P02” and start to countdown when pressure rises in the cooker.

Preset Cooking:

- In standby mode, press the “Menu” button.
- The “” indicator light will turn on.
- The LED display will flash “P01”.
- Now press the “+” button once.
- The LED display will show “P02”.
- Press the “Delay Timer” button. The “Delay Timer” indicator will begin to flash. The LED display will flash the amount of preset time.
- Adjust the amount of preset time by pressing the “+”/“-” buttons. Each adjustment will adjust the amount of preset time by 10 (ten) minutes.
- 10 (ten) seconds after setting the preset time, the appliance will automatically start preset cooking using the “Poultry” setting. The LED display will show the cooking cycle finishing time and start to countdown.

To Exit the Cooking Cycle/ Mode:

- Press the “Keep Warm” button to exit the current cooking cycle/ mode.

Vegetables Setting

Normal Cooking:

- In standby mode, press the “Menu” button.
- The “” indicator light will turn on.
- The LED display will flash “P01”.
- Now press the “+” button 2 (two) times until you reach the “Vegetables” menu setting.
- The LED display will show “P03”.
- 10 (ten) seconds later if no button is pressed, the appliance will automatically start cooking using the “Vegetables” setting/ mode.
- The LED display will show “P03” and start to countdown when pressure rises in the cooker.

Preset Cooking:

- In standby mode, press the “Menu” button.
- The “” indicator light will turn on.
- The LED display will flash “P01”.
- Now press the “+” button 2 (two) times until you reach the “Vegetables” menu setting.
- The LED display will show “P03”.
- Press the “Delay Timer” button. The “Delay Timer” indicator will begin to flash. The LED display will flash the amount of preset time.
- Adjust the amount of preset time by pressing the “+”/“-” buttons. Each adjustment will adjust the amount of preset time by 10 (ten) minutes.
- 10 (ten) seconds after setting the preset time, the appliance will automatically start preset cooking using the “Vegetables” setting. The LED display will show the cooking cycle finishing time and start to countdown.

To Exit the Cooking Cycle/ Mode:

- Press the “Keep Warm” button to exit the current cooking cycle/ mode.

Steam Setting

Normal Cooking:

- In standby mode, press the “Menu” button.
- The “” indicator light will turn on.
- The LED display will flash “P01”.
- Now press the “+” button 3 (three) times until you reach the “Steam” menu setting.
- The LED display will show “P04”.
- 10 (ten) seconds later if no button is pressed, the appliance will automatically start cooking using the “Steam” setting/ mode.
- The LED display will show “P04” and start to countdown when pressure rises in the cooker.

Preset Cooking:

- In standby mode, press the “Menu” button.
- The “” indicator light will turn on.
- The LED display will flash “P01”.
- Now press the “+” button 3 (three) times until you reach the “Steam” menu setting.
- The LED display will show “P04”.
- Press the “Delay Timer” button. The “Delay Timer” indicator will begin to flash. The LED display will flash the amount of preset time.
- Adjust the amount of preset time by pressing the “+”/“-” buttons. Each adjustment will adjust the amount of preset time by 10 (ten) minutes.
- 10 (ten) seconds after setting the preset time, the appliance will automatically start preset cooking using the “Steam” setting. The LED display will show the cooking cycle finishing time and start to countdown.

To Exit the Cooking Cycle/ Mode:

- Press the “Keep Warm” button to exit the current cooking cycle/ mode.

Sauté Setting

Normal Cooking:

- In standby mode, press the “Menu” button.
- The “” indicator light will turn on.
- The LED display will flash “P01”.
- Now press the “+” button 4 (four) times until you reach the “Sauté” menu setting.
- The LED display will show “P05”.
- 10s later if no button is pressed,
- The appliance will automatically start cooking using the “Sauté” setting.
- The LED display will show and countdown from “0:30”.

To Exit the Cooking Cycle/ Mode:

- Press the “Keep Warm” button to exit the current cooking cycle/ mode.

Slow Cook Setting

Normal Cooking:

- In standby mode, press the “Menu” button.
- The “” indicator light will turn on.
- The LED display will flash “P01”.
- Now press the “+” button 5 (five) times until you reach the “Slow Cook” menu setting.
- The LED display will show “P06”.
- 10 (ten) seconds later if no button is pressed, the appliance will automatically start cooking using the “Slow Cook” setting/ mode.
- The appliance will automatically start cooking using the “Slow Cook” setting.
- The LED display will show and countdown from “8:00”.

To Exit the Cooking Cycle/ Mode:

- Press the “Keep Warm” button to exit the current cooking cycle/ mode.

White Rice Setting

Normal Cooking:

- In standby mode, press the “Menu” button.
- The “” indicator light will turn on.
- The LED display will flash “P01”.
- Now press the “+” button 6 (six) times until you reach the “White Rice” menu setting.
- The LED display will now show “P07”.
- 10 (ten) seconds later if no button is pressed, the appliance will automatically start cooking using the “White Rice” setting/ mode.
- The LED display will show “P07” and start to countdown when pressure rises in the cooker.

Preset Cooking:

- In standby mode, press the “Menu” button.
- The “” indicator light will turn on.
- The LED display will flash “P01”.
- Now press the “+” button 6 (six) times until you reach the “White Rice” menu setting.
- The LED display will now show “P07”.
- Press the “Delay Timer” button. The “Delay Timer” indicator will begin to flash. The LED display will flash the amount of preset time.
- Adjust the amount of preset time by pressing the “+”/“-” buttons. Each adjustment will adjust the amount of preset time by 10 (ten) minutes.
- 10 (ten) seconds after setting the preset time, the appliance will automatically start preset cooking using the “White Rice” setting. The LED display will show the cooking cycle finishing time and start to countdown.

To Exit the Cooking Cycle/ Mode:

- Press the “Keep Warm” button to exit the current cooking cycle/ mode.

Brown Rice Setting

Normal Cooking:

- In standby mode, press the “Menu” button.
- The “” indicator light will turn on.
- The LED display will flash “P01”.
- Now press the “+” button 7 (seven) times until you reach the “Brown Rice” menu setting.
- The LED display will show “P08”.
- 10 (ten) seconds later if no button is pressed, the appliance will automatically start cooking using the “Brown Rice” setting/ mode.
- The LED display will show “P08” and start to countdown when pressure rises in the cooker.

Preset Cooking:

- In standby mode, press the “Menu” button.
- The “” indicator light will turn on.
- The LED display will flash “P01”.
- Now press the “+” button 7 (seven) times until you reach the “Brown Rice” menu setting.
- The LED display will show “P08”.
- Press the “Delay Timer” button. The “Delay Timer” indicator will begin to flash. The LED display will flash the amount of preset time.
- Adjust the amount of preset time by pressing the “+”/“-” buttons. Each adjustment will adjust the amount of preset time by 10 (ten) minutes.
- 10 (ten) seconds after setting the preset time, the appliance will automatically start preset cooking using the “Brown Rice” setting. The LED display will show the cooking cycle finishing time and start to countdown.

To Exit the Cooking Cycle/ Mode:

- Press the “Keep Warm” button to exit the current cooking cycle/ mode.

Beans Setting

Normal Cooking:

- In standby mode, press the “Menu” button.
- The “” indicator light will turn on.
- The LED display will flash “P01”.
- Now press the “+” button 8 (eight) times until you reach the “Beans” menu setting.
- The LED display will show “P09”.
- 10 (ten) seconds later if no button is pressed, the appliance will automatically start cooking using the “Beans” setting/ mode.
- The LED display will show “P09” and start to countdown when pressure rises in the cooker.

Preset Cooking:

- In standby mode, press the “Menu” button.
- The “” indicator light will turn on.
- The LED display will flash “P01”.
- Now press the “+” button 8 (eight) times until you reach the “Beans” menu setting.
- The LED display will show “P09”.
- Press the “Delay Timer” button. The “Delay Timer” indicator will begin to flash. The LED display will flash the amount of preset time.
- Adjust the amount of preset time by pressing the “+”/“-” buttons. Each adjustment will adjust the amount of preset time by 10 (ten) minutes.
- 10 (ten) seconds after setting the preset time, the appliance will automatically start preset cooking using the “Beans” setting. The LED display will show the cooking cycle finishing time and start to countdown.

To Exit the Cooking Cycle/ Mode:

- Press the “Keep Warm” button to exit the current cooking cycle/ mode.

Broth Setting

Normal Cooking:

- In standby mode, press the “Menu” button.
- The “” indicator light will turn on.
- The LED display will flash “P01”.
- Now press the “+” button 9 (nine) times until you reach the “Broth” menu setting.
- The LED display will show “P10”.
- 10 (ten) seconds later if no button is pressed, the appliance will automatically start cooking using the “Broth” setting/ mode.
- The LED display will show “P10” and start to countdown when pressure rises in the cooker.

Preset Cooking:

- In standby mode, press the “Menu” button.
- The “” indicator light will turn on.
- The LED display will flash “P01”.
- Now press the “+” button 9 (nine) times until you reach the “Broth” menu setting.
- The LED display will show “P10”.
- Press the “Delay Timer” button. The “Delay Timer” indicator will begin to flash. The LED display will flash the amount of preset time.
- Adjust the amount of preset time by pressing the “+”/“-” buttons. Each adjustment will adjust the amount of preset time by 10 (ten) minutes.
- 10 (ten) seconds after setting the preset time, the appliance will automatically start preset cooking using the “Broth” setting. The LED display will show the cooking cycle finishing time and start to countdown.

To Exit the Cooking Cycle/ Mode:

- Press the “Keep Warm” button to exit the current cooking cycle/ mode.

Curry Setting

Normal Cooking:

- In standby mode, press the “Menu” button.
- The “” indicator light will turn on.
- The LED display will flash “P01”.
- Now press the “+” button 10 (ten) times until you reach the “Curry” menu setting.
- The LED display will show “P11”.
- 10 (ten) seconds later if no button is pressed, the appliance will automatically start cooking using the “Curry” setting/ mode.
- The LED display will show “P11” and start to countdown when pressure rises in the cooker.

Preset Cooking:

- In standby mode, press the “Menu” button.
- The “” indicator light will turn on.
- The LED display will flash “P01”.
- Now press the “+” button 10 (ten) times until you reach the “Curry” menu setting.
- The LED display will show “P11”.
- Press the “Delay Timer” button. The “Delay Timer” indicator will begin to flash. The LED display will flash the amount of preset time.
- Adjust the amount of preset time by pressing the “+”/“-” buttons. Each adjustment will adjust the amount of preset time by 10 (ten) minutes.
- 10 (ten) seconds after setting the preset time, the appliance will automatically start preset cooking using the “Curry” setting. The LED display will show the cooking cycle finishing time and start to countdown.

To Exit the Cooking Cycle/ Mode:

- Press the “Keep Warm” button to exit the current cooking cycle/ mode.

Soup Setting

Normal Cooking:

- In standby mode, press the “Menu” button.
- The “” indicator light will turn on.
- The LED display will flash “P01”.
- Now press the “+” button 11 (eleven) times to reach the “Soup” menu setting.
- The LED display will show “P12”.
- 10 (ten) seconds later if no button is pressed, the appliance will automatically start cooking using the “Soup” setting/ mode.
- The LED display will show “P12” and start to countdown when pressure rises in the cooker.

Preset Cooking:

- In standby mode, press the “Menu” button.
- The “” indicator light will turn on.
- The LED display will flash “P01”.
- Now press the “+” button 11 (eleven) times to reach the “Soup” menu setting.
- The LED display will show “P12”.
- Press the “Delay Timer” button. The “Delay Timer” indicator will begin to flash. The LED display will flash the amount of preset time.
- Adjust the amount of preset time by pressing the “+”/“-” buttons. Each adjustment will adjust the amount of preset time by 10 (ten) minutes.
- 10 (ten) seconds after setting the preset time, the appliance will automatically start preset cooking using the “Soup” setting. The LED display will show the cooking cycle finishing time and start to countdown.

To Exit the Cooking Cycle/ Mode:

- Press the “Keep Warm” button to exit the current cooking cycle/ mode.

Multigrain Setting

Normal Cooking:

- In standby mode, press the “Menu” button.
- The “” indicator light will turn on.
- The LED display will flash “P01”.
- Now press the “+” button 12 (twelve) times to reach the “Multigrain” menu setting.
- The LED display will show “P13”.
- 10 (ten) seconds later if no button is pressed, the appliance will automatically start cooking using the “Multigrain” setting/ mode.
- The LED display will show “P13” and start to countdown when pressure rises in the cooker.

Preset Cooking:

- In standby mode, press the “Menu” button.
- The “” indicator light will turn on.
- The LED display will flash “P01”.
- Now press the “+” button 12 (twelve) times to reach the “Multigrain” menu setting.
- The LED display will show “P13”.
- Press the “Delay Timer” button. The “Delay Timer” indicator will begin to flash. The LED display will flash the amount of preset time.
- Adjust the amount of preset time by pressing the “+”/“-” buttons. Each adjustment will adjust the amount of preset time by 10 (ten) minutes.
- 10 (ten) seconds after setting the preset time, the appliance will automatically start preset cooking using the “Multigrain” setting. The LED display will show the cooking cycle finishing time and start to countdown.

To Exit the Cooking Cycle/ Mode:

- Press the “Keep Warm” button to exit the current cooking cycle/ mode.

Congee Setting

Normal Cooking:

- In standby mode, press the “Menu” button.
- The “” indicator light will turn on.
- The LED display will flash “P01”.
- Now press the “+” button 13 (thirteen) times to reach the “Congee” menu setting.
- The LED display will show “P14”.
- 10 (ten) seconds later if no button is pressed, the appliance will automatically start cooking using the “Congee” setting/ mode.
- The LED display will show “P14” and start to countdown when pressure rises in the cooker.

Preset Cooking:

- In standby mode, press the “Menu” button.
- The “” indicator light will turn on.
- The LED display will flash “P01”.
- Now press the “+” button 13 (thirteen) times to reach the “Congee” menu setting.
- The LED display will show “P14”.
- Press the “Delay Timer” button. The “Delay Timer” indicator will begin to flash. The LED display will flash the amount of preset time.
- Adjust the amount of preset time by pressing the “+”/“-” buttons. Each adjustment will adjust the amount of preset time by 10 (ten) minutes.
- 10 (ten) seconds after setting the preset time, the appliance will automatically start preset cooking using the “Congee” setting. The LED display will show the cooking cycle finishing time and start to countdown.

To Exit the Cooking Cycle/ Mode:

- Press the “Keep Warm” button to exit the current cooking cycle/ mode.

Chili Setting

Normal Cooking:

- In standby mode, press the “Menu” button.
- The “” indicator light will turn on.
- The LED display will flash “P01”.
- Press the “+” button 14 (fourteen) times to reach the “Chili” menu setting.
- The LED display will show “P15”.
- 10 (ten) seconds later if no button is pressed, the appliance will automatically start cooking using the “Chili” setting/ mode.
- The LED display will show “P15” and start to countdown when pressure rises in the cooker.

Preset Cooking:

- In standby mode, press the “Menu” button.
- The “” indicator light will turn on.
- The LED display will flash “P01”.
- Press the “+” button 14 (fourteen) times to reach the “Chili” menu setting.
- The LED display will show “P15”.
- Press the “Delay Timer” button. The “Delay Timer” indicator will begin to flash. The LED display will flash the amount of preset time.
- Adjust the amount of preset time by pressing the “+”/“-” buttons. Each adjustment will adjust the amount of preset time by 10 (ten) minutes.
- 10 (ten) seconds after setting the preset time, the appliance will automatically start preset cooking using the “Chili” setting. The LED display will show the cooking cycle finishing time and start to countdown.

To Exit the Cooking Cycle/ Mode:

- Press the “Keep Warm” button to exit the current cooking cycle/ mode.

Manual Setting

Normal Cooking:

- In standby mode, press the “Manual” setting button.
- Both the “Manual” and “High” indicator lights will turn on.

- The LED display will show “30” (thirty).
- 10 (ten) seconds later if no button is pressed, the appliance will automatically start cooking using the “Manual” setting.
- The LED display will show “” and start to countdown when pressure rises in the appliance.

Preset Cooking:

- In standby mode, press the “Manual” setting button.
- Both the “Manual” and “High” indicator lights will turn on.
- The LED display will show “30” (thirty).
- Press the “Delay Timer” button. The “Delay Timer” indicator will begin to flash. The LED display will flash the amount of preset time.
- Adjust the amount of preset time by pressing the “+”/“-” buttons. Each adjustment will adjust the amount of preset time by 10 (ten) minutes.
- 10 (ten) seconds after setting the preset time, the appliance will automatically start preset cooking using the “Manual” setting. The LED display will show the cooking cycle finishing time and start to countdown.

Pressure Selection:

- In standby mode, press the “Manual” setting button.
- Both the “Manual” and “High” indicator lights will turn on.
- The LED display will show “30” (thirty).
- Adjust the required pressure level by pressing the “Pressure Level” button.
- The “High” indicator light will turn off and the “Low” indicator light will turn on.
- 10 (ten) seconds later if no button is pressed, the appliance will automatically start cooking using the “Manual Setting”.
- The LED display will show “” and start to countdown when pressure rises in the appliance.

To Exit the Cooking Cycle/ Mode:

- Press the “Keep Warm” button to exit the current cooking cycle/ mode.

KEEP WARM FUNCTION

- After the cooking cycle has completed, the electric pressure cooker automatically enters into the keep warm mode.
- In this mode, the Keep Warm indicator lights will be on.
- In standby mode, you may also press the Keep Warm button to turn the Keep Warm mode/ function on.
- Note: the Keep Warm temperature is 60°C-77°C. The preset cycle time for this mode/ function is no longer than 2 (two) hours.

CLEANING AND MAINTENANCE

- This appliance is for household use only and is not user-serviceable.
- Do not open or change any parts by yourself. Please refer to a qualified electrical service department or return to the supplier if servicing is necessary.
- Always make sure the Pressure Cooker is unplugged, depressurized and completely cooled down before dismantling.
- Clean after each use.
- Do not use bleach or other abrasive substances or solvents to clean your appliance as it can be damaging to the finish.
- Use a non-abrasive sponge or damp wash cloth to clean the exterior of the outer body and the exterior surface of the pressure cooker. **NEVER** immerse the pressure cooker in any liquids.
- Remove the water box/ collector and rinse it thoroughly and let it dry. Clean the upper body of the main cooker body with a damp sponge or wash cloth.
- Clean the lid with warm soapy water, including the seal ring, exhaust valve, block proof cover, vents, float valve and let them dry thoroughly.
- The exhaust valve pops off easily by gently reaching underneath it and gently pulling it upwards. Be careful not to damage supporting structure/ parts under it.
- Wash the inner pot with a non-abrasive sponge and allow to air dry or use a towel.
- Clean the exhaust valve and the holes with a small brush to ensure smooth flow of steam during the release cycle.
- Let parts dry completely before reassembling.
- To remove stubborn spots/marks, wipe the surfaces with a cloth slightly dampened in soapy water or mild non-abrasive cleaner.

STORING THE APPLIANCE

- Unplug the unit from the wall outlet and clean all the parts as instructed above. Ensure that all parts are dry before storing.
- Store the appliance in its box or in a clean, dry place.
- Never store the appliance while it is still wet or dirty.
- Never wrap the power cord around the appliance.

PROBLEM SOLVING

Number	Situation	Cause	Solution
1	It is difficult to close the lid.	The sealing ring is not installed properly. The floater valve clamps the push rod.	Position the sealing ring well. Lightly push the push rod.
2	It is difficult to close the lid.	The float valve is in the popped-up position. Pressure exists inside the cooker.	Press the float valve lightly. Open the lid after the pressure is completely released.
3	Steam leaks from the lid.	The sealing ring is installed improperly. Food debris is attached to the sealing ring.	Install the sealing ring as required. Clean the sealing ring. Replace the sealing ring.

		The sealing ring damaged. The lid is not closed correctly.	Close the lid correctly.
4	Steam leaks from the float valve.	Food debris on the float valve gasket. The float valve gasket is worn-out.	Clean the float valve gasket. Replace the float valve gasket.
5	The float valve is unable to rise.	Too little food and water in the inner pot. Steam leaks from the lid or exhaust valve.	Add water and food according to the recipe. Send to the service center for repair.
6	Steam escapes from the exhaust valve non-stop.	The exhaust valve is not in the sealing position. Pressure control fails.	Turn the exhaust valve to the sealing position. Send to the service center for repair.
7	The power indicator doesn't light/ turn on.	Power socket has bad contact.	Please check the power socket.
8	All indicators flash: LED display shows E1	Bottom sensor fault.	Send to the service center for repair.

	LED display shows E2	Bottom sensor fault.	Send to the service center for repair.
	LED display shows C1	High temperature since there isn't water in the inner pot.	Add water according to the requirement. Put the inner pot correctly.
	LED display shows E8	Pressure switch fault.	Send to the service center for repair
9	Rice is half cooked or too hard.	Too little water. Lid opened prematurely.	Add water accordingly. After the cooking cycle completes, leave the lid on for 5 more minutes.
10	Rice is too soft.	Too much water.	Reduce water accordingly.

SERVICING THE APPLIANCE

There are no user serviceable parts in this appliance. If the unit is not operating correctly, please check the following:

- You have followed the instructions correctly
- That the unit has been wired correctly and that the wall socket is switched on.
- That the mains power supply is ON.
- That the plug is firmly in the mains socket.

If the appliance still does not work after checking the above:

- Consult the retailer for possible repair or replacement. If the retailer fails to resolve the problem and you need to return the appliance, make sure that:

- The unit is packed carefully back into its original packaging.
- Proof of purchase is attached.

- A reason is provided for why it is being returned.

If the supply cord is damaged, it must be replaced by the manufacturer or an authorised service agent, in order to avoid any hazard. If service becomes necessary within the warranty period, the appliance should be returned to an approved Home of Living Brands (PTY) Limited service centre. Servicing outside the warranty period is still available, but will, however, be chargeable.

COOKING GUIDE

Place the indicated amount of water into the inner cooking pot. The amount needed will vary according to the type and method of food being cooked. More time will be needed for tender/softer vegetables and less time for crispier vegetables. For all food items start with 2 cups of water in the bottom of the inner cooking pot.

FOOD	WEIGHT	TREATMENT	COOKING TIME	PRESSURE FUNCTION	PRESSURE RELEASE/ EXHAUST METHOD
Vegetables					
Asparagus	240g	Whole	9-11 minutes	Low	Quick/ Manual Release
Broccoli/Zucchini	240g	35-50mm flowerets half lengthwise	11 minutes	High	Quick/ Manual Release
Carrots	240g	6mm slices	15 minutes	High	Quick/ Manual Release
Green beans	120g	Whole	8-9 minutes	Low	Quick/ Manual Release
Potatoes	240g	Quarters	24 minutes	High	Quick/ Manual Release
Chickpeas (2 ½ cups cooked)	1 cup	Unsoaked	40-60 minutes	High	Quick/ Manual

beans)					Release
Lentils (2 cups cooked lentils)	1 cups	Unsoaked	6-8 minutes	High	Quick/ Manual Release
Chicken					
Chicken (whole)	1Kg	-	28 minutes	High	Quick/ Manual Release
Chicken Breast	1Kg	-	5-6 minutes	High	Quick/ Manual Release
Chicken Thighs	-	-	9-12 minutes	High	Quick/ Manual Release
Chicken Leg	-	-	8-10 minutes	High	Quick/ Manual Release
Beef					
Beef Pot Roast	1.5Kg	-	35-40 minutes	High	Natural Release
Beef Shanks	-	-	25-30 minutes	High	Natural Release
Beef Stew	Per 500g	2cm cubes	10-14 minutes	High	Natural Release
Lamb					
Lamb Shanks	350g	-	25-30 minutes	High	Natural Release
Lamb Shoulder	-	5cm cubes	20-25 minutes	High	Natural Release
Veal					
Veal Shoulder	500g	-	10 minutes per shoulder	High	Natural Release
Veal Osso Bucco	-	-	40 minutes per shoulder	High	Natural Release
Pork					
Pork Chops	4	2-5cm	9-11 minutes	High	Quick/ Manual Release

Pork Ribs	1Kg	-	18-22 minutes	High	Quick/ Manual Release
Pork Roast	1.4Kg	-	40 minutes	High	Natural Release
Seafoods					
Scallops	Up to 500g	-	10-15 minutes	Low	Quick/ Manual Release
Fish Fillets	Up to 500g	Wrapped in a parcel	10-15 minutes	Low	Quick/ Manual Release
Whole fish	Up to 500g	Wrapped in a parcel	15-25 minutes	Low	Quick/ Manual Release
Rice					
Arborio/ Rissoto	1 cup rice to 3 cups of water. With 1 to 2 tbsp. of butter or oil.	-	6-8 minutes	High	Quick/ Manual Release
White (Yields 4 - 4 ½ cups of cooked long grain rice)	1 ½ cups of rice to 2 ¼ cups of water. With 1 tbsp. of butter or oil.	-	7-8 minutes	High	Natural Release
Wild	Max: 2 cups of rice to 6 ½ cups of water. With 1 to 2 tbsp. of butter or oil.	-	20-30 minutes	High	Natural Release
Brown	Max: 2 cups of rice to 6 ½ cups	-	10-20 minutes	High	Natural Release

	of water. With 1 to 2 tbsp. of butter or oil.				
--	--	--	--	--	--

Note: If recipes require the use of a trivet, riser (wire rack), foil or heat resistant/ pressure resistant oven-safe cookware, you may use the accessories provided with this unit. If you do not have a wire rack that will fit, simply use 3-4 mason jar lids or regular jar lids for a simple 1-inch riser.

CHANGING THE PLUG

Should the need arise to change the fitted plug, follow the instructions below.

This unit is designed to operate on the stated current only. Connecting to other power sources may damage the appliance. Connect a three-pin plug as follows:

The wires in this mains lead are coloured in accordance with the following code:

Green/Yellow = Earth
Blue = Neutral
Brown = Live

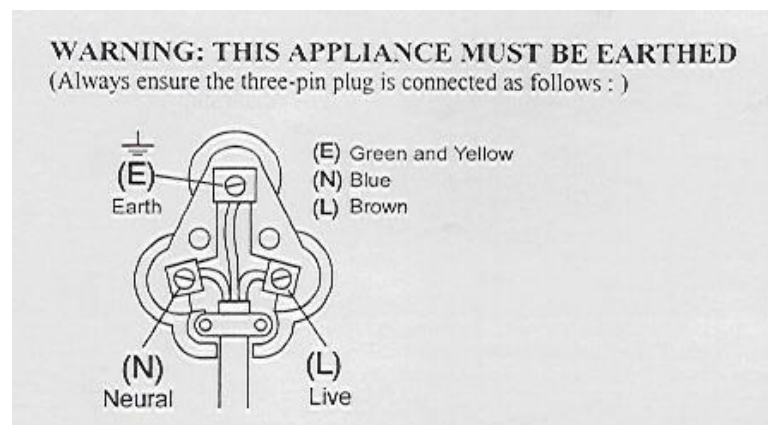

PLEASE AFFIX YOUR PROOF OF PURCHASE/RECEIPT HERE
IN THE EVENT OF A CLAIM UNDER WARRANTY THIS RECEIPT MUST BE PRODUCED.

W A R R A N T Y

1. Home of Living Brands (Pty) Limited (“Home of Living Brands”) warrants to the original purchaser of this product (“the customer”) that this product will be free of defects in quality and workmanship which under normal personal, family or household use and purpose may manifest within a period of 1 (one) year from the date of purchase (“warranty period”).
2. Where the customer has purchased a product and it breaks, is defective or does not work properly for the intended purpose, the customer must notify the supplier from whom the customer bought the product (“the supplier”) thereof within the warranty period. Any claim in terms of this warranty must be supported by a proof of purchase. If proof of purchase is not available, then repair, and/or service charges may be payable by the customer to the supplier.
3. The faulty product must be taken to the supplier's service centre to exercise the warranty.
4. The supplier will refund, repair or exchange the product in terms of this warranty subject to legislative requirements. This warranty shall be valid only where the customer has not broken the product himself, or used the product for something that it is not supposed to be used for. The warranty does not include and will not be construed to cover products damaged as a result of disaster, misuse, tamper, abuse or any unauthorised modification or repair of the product.
5. This warranty will extend only to the product provided at the date of the purchase and not to any expendables attached or installed by the customer.
6. If the customer requests that the supplier repairs the product and the product breaks or fails to work properly within 3 (three) months of the repair and not as a result of misuse, tampering or modification by or on behalf of the customer, then the supplier may replace the product or pay a refund to the customer.
7. The customer may be responsible for certain costs where products returned are not in the original packaging, or if the packaging is damaged. This will be deducted from any refund paid to the customer.

HOME OF LIVING BRANDS (PTY) LTD (JOHANNESBURG)

JOHANNESBURG

TEL NO. (011) 490-9600

CAPE TOWN

TEL NO. (021) 552-5161

DURBAN

TEL NO. (031) 792-6000

www.homeoflivingbrands.com

www.russellhobbs.co.za

www.facebook.com/RussellHobbsSA