

Russell Hobbs RHEO6501B-M Owner's Manual

[Shop genuine replacement parts for Russell Hobbs
RHEO6501B-M](#)

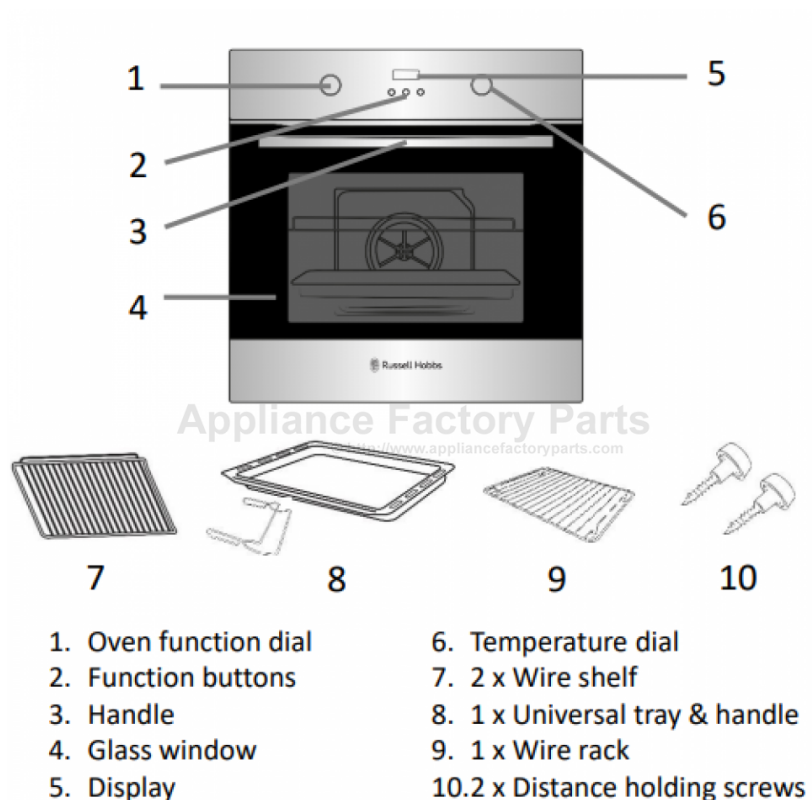

[Find Your Russell Hobbs Cooker Parts - Select From 29 Models](#)

----- Manual continues below -----



Russell Hobbs

Oven Instruction Manual

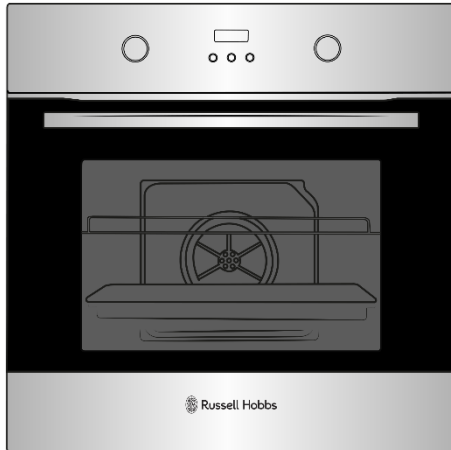

Model number(s):
RHEO6501B-M (SS-M)

For Customer Services & Spare Parts please call **0345 208 8750**
Opening times: Monday - Friday 8am – 8pm & Saturday 9am – 1pm
or visit us at www.productcare.co.uk

IMPORTANT:
RETAIN FOR FUTURE REFERENCE

Contents

Safety Instructions	3-5
Product Overview	6
Positioning	7
Installation	8-9
Usage	10-24
Cleaning & Maintenance	25-27
Trouble shooting	28
Guarantee	29
Technical specification	30
Notes	31



For Customer Services & Spare Parts please call **0345 208 8750**
Opening times: Monday - Friday 8am – 8pm & Saturday 9am – 1pm
or visit us at www.productcare.co.uk

Safety Instructions

Important note:

Please read this booklet before installing and switching on this appliance. The manufacturer assumes no responsibility for incorrect installation and usage as described in this booklet.

This appliance can be used by children aged from 8 years and above and persons with reduced physical, sensory or mental capabilities or lack of experience and knowledge if they have been given supervision or instruction concerning use of the appliance in a safe way and understand the hazards involved. Children shall not play with the appliance.

Electric ovens and hobs must be hard-wired to a suitably rated electrical cooker power point – it is recommended that you consult a qualified electrician. Failure to do so will invalidate your guarantee, liability claims and could lead to criminal prosecution

- Children should be supervised to ensure that they do not play with the appliance.
- If the supply lead is damaged it must be replaced by a qualified person using the correct lead, available from **0345 208 8750**.
- Packaging material is dangerous to children. Never allow children to play with packaging material.
- Check the appliance for damage after unpacking it. Do not connect the appliance if it has been damaged in transport.
- The appliance can only be used safely if it is correctly installed according to the safety instructions. The installer is responsible for ensuring that the appliance works correctly after installation.
- All operations relating to installation and regulation must be carried out by an authorised installation engineer, respecting applicable regulations, standards and the specifications of the local electricity providers.



For Customer Services & Spare Parts please call **0345 208 8750**
Opening times: Monday - Friday 8am – 8pm & Saturday 9am – 1pm
or visit us at www.productcare.co.uk

Safety Instructions

- This appliance can only be installed in a well-ventilated place in accordance with existing regulations and ventilation specifications.
- This appliance is intended for domestic use and the household environment only. The appliance is not intended for use outside.
- Do not tamper with the appliance's interior. If necessary, call our customer helpline
- Do not switch on the appliance if it is damaged in any way. Contact our customer helpline
- This appliance is only intended for cooking purposes, not as a heating system.
- Do not leave the appliance unattended during operation. The manufacturer is not liable for damage which is caused by improper use or incorrect operation.
- Combustible items stored in the cooking compartment may catch fire. Never store combustible items in the cooking compartment. Never open the appliance door if there is smoke inside. Switch off the appliance and unplug it from the mains or switch off the circuit breaker in the fuse box.
- A draught is created when the appliance door is opened. Greaseproof paper may come into contact with the heating element and catch fire. Do not place greaseproof paper loosely over accessories during preheating. Always weight down the greaseproof paper with a dish or a baking tin. Only cover the surface required with greaseproof paper. Greaseproof paper must not protrude over the accessories.
- Always slide accessories into the cooking compartment
- The appliance becomes very hot. Never touch the interior surfaces of the cooking compartment or the heating elements. Always allow the appliance to cool down. Keep children at a safe distance.
- Accessories and ovenware become very hot. Always use oven gloves to remove accessories or ovenware from the cooking compartment.
- Shelves and the universal tray only must be placed and used between the 5 side supports.
- The universal tray or any other kind of baking tray should not be placed on the bottom of the oven cavity.



For Customer Services & Spare Parts please call **0345 208 8750**
Opening times: Monday - Friday 8am – 8pm & Saturday 9am – 1pm
or visit us at www.productcare.co.uk

Safety Instructions

- Alcoholic vapours may catch fire in the hot cooking compartment. Never prepare food containing large quantities of drinks with a high alcohol content. Only use small quantities of drinks with a high alcohol content. Open the appliance door with care.
- The accessible parts become very hot when in operation. Never touch hot parts. Keep children at a safe distance.
- When you open the appliance door, hot steam may escape. Open the appliance door with care. Keep children at a safe distance.
- Water in a hot cooking compartment may create hot steam. Never pour water into the hot cooking compartment.
- Scratched glass in the appliance door may develop into a crack. Do not use a glass scraper, sharp or abrasive cleaning aids or detergents.
- The appliance gets hot. Do not keep combustible objects or aerosol cans in drawers directly underneath the appliance.
- A defective appliance may cause electric shock. Never switch on a defective appliance. Unplug the appliance from the mains or switch off the circuit breaker in the fuse box. Contact the customer services.
- The cable insulation on electrical appliances may melt when touching hot parts of the appliance. Never bring electrical appliance cables into contact with hot parts of the appliance.
- Penetrating moisture may cause an electric shock. Do not use any high pressure cleaners or steam cleaners.
- When replacing the cooking compartment bulb, the bulb socket contacts are live. Before replacing the bulb, unplug the appliance from the mains or switch off the circuit breaker in the fuse box.
- Incorrect repairs are dangerous. Repairs may only be carried out by a qualified electrician.
- Never use strong and abrasive cleaning agents as they will cause surface damage.
- In the event of a malfunction, turn off the appliance's electricity supply. For repairs, call customer services.
- Carrying the appliance: do not carry or hold the appliance by the door handle.



Russell Hobbs

For Customer Services & Spare Parts please call **0345 208 8750**
Opening times: Monday - Friday 8am – 8pm & Saturday 9am – 1pm
or visit us at www.productcare.co.uk

Product overview

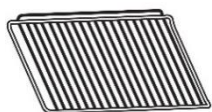
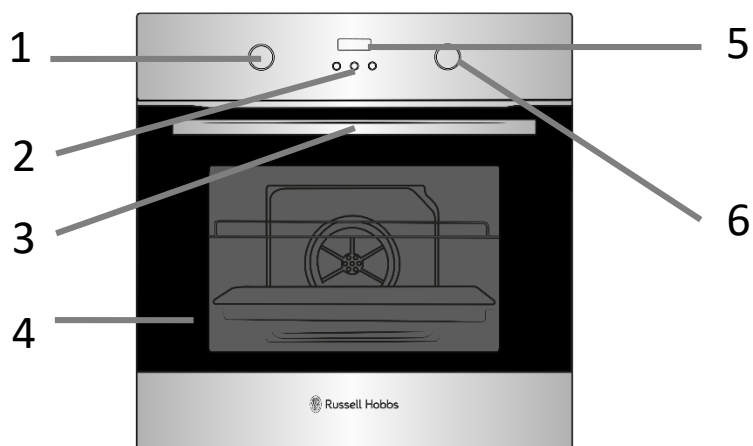

7

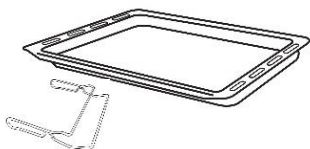

8

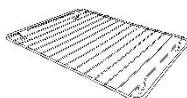

9

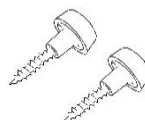

10

1. Oven function dial
2. Function buttons
3. Handle
4. Glass window
5. Display

6. Temperature dial
7. 2 x Wire shelf
8. 1 x Universal tray & handle
9. 1 x Wire rack
10. 2 x Distance holding screws

Unit & Spare Parts

If any of the above parts are missing please contact the customer service team on 0345 208 8750 or visit www.productcare.co.uk



For Customer Services & Spare Parts please call **0345 208 8750**
Opening times: Monday - Friday 8am – 8pm & Saturday 9am – 1pm
or visit us at www.productcare.co.uk

Positioning

- This appliance is to be installed under a counter top or in cabinets.
- Avoid damaging the product during installation.
- The appliance can only be used safely if it is correctly installed according to the safety instructions. The installer is responsible for ensuring that the appliance works correct when installed.
- **Electric ovens and hobs must be hard-wired to a suitably rated electrical cooker power point – it is recommended that you consult a qualified electrician. Failure to do so will invalidate your guarantee, liability claims and could lead to criminal prosecution.**
- The aperture size has to be (H)600 x (W)560 x (D)570mm (please note that the depth size is a minimum measure, the oven can be installed in an aperture that has a bigger depth).

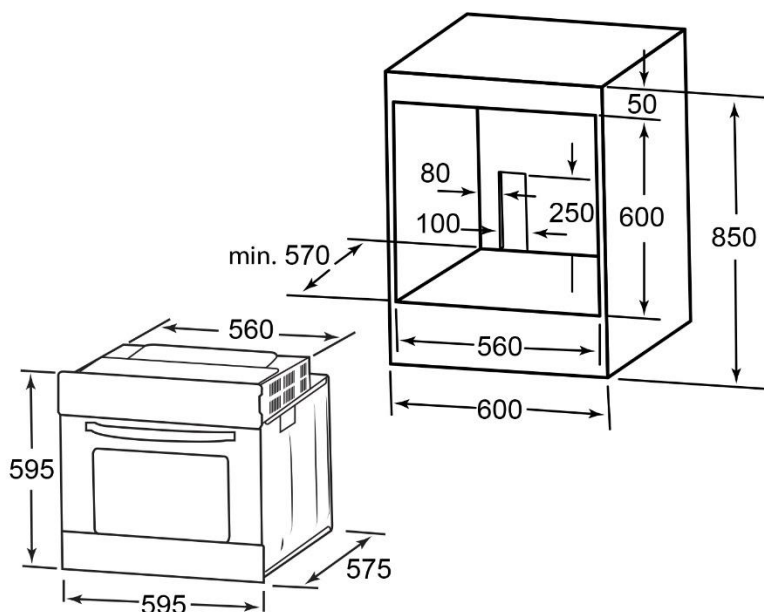

Note:

- **Select heat-resistant work surface material to avoid larger deformation caused by the heat radiation from the appliance.**
- **This oven has forced air ventilation.**

 **Russell Hobbs**

For Customer Services & Spare Parts please call **0345 208 8750**
Opening times: Monday - Friday 8am – 8pm & Saturday 9am – 1pm
or visit us at www.productcare.co.uk

Installation

Preparation & installation

Ensure that there are no electric wires, gas or water pipes in the area where holes are to be made.

Components of the appliance may have sharp edges. Wear protective gloves.

1. Ensure that there is an electrical power point within adequate distance of the oven after it has been installed.
2. Ensure the aperture measures (H)600 x (W)560 x (D)570mm, in accordance with the positioning instructions detailed on the previous page.
3. Carefully and gently put the oven into the aperture recess, making sure that power cable can still be accessed.
4. Connect the oven to the electrical power point before pushing the oven into the aperture fully.
5. Once this is done open the oven door and secure the oven to the kitchen cabinet with two distance holding screws which fit the holes in the oven frame.

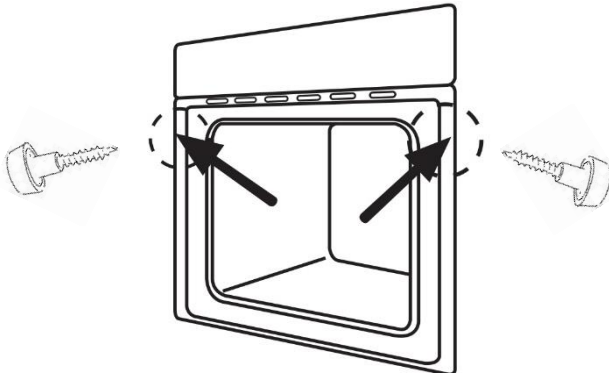

 **Russell Hobbs**

For Customer Services & Spare Parts please call **0345 208 8750**
Opening times: Monday - Friday 8am – 8pm & Saturday 9am – 1pm
or visit us at www.productcare.co.uk

Installation

Electrical connection

- **WARNING-** THIS APPLIANCE MUST BE EARTHED
- This appliance is designed to be connected to a 220-240V~50Hz AC electricity supply.
- Before proceeding with the electrical connection, verify that the current carrying capacity of the system and the isolator / main switch is adequate for the maximum power rating of the oven.
- Electrical installation of the residence and of the appliance's isolator must be earthed and conform with the required safety regulations.
- If there is no suitable circuit and a fused switch, they must be installed by a qualified electrician before the hob is connected.
- An isolator switch must be easily accessible once the oven has been installed.
- Do not use adaptors, multiple sockets and/or extension leads.
- A circuit breaker with a contact opening of at least 3 mm, rated 32A and delayed functioning type must be installed inside the supply circuit.
- During installation, please ensure that insulated cables are used. An incorrect connection might damage your appliance and will void the manufacturer's guarantee.
- All repairs must be carried out by an authorised service personal or a qualified electrician.
- Switch off/isolate your appliance before each maintenance.
- The GREEN/YELLOW wire is the EARTH and must be connected to the terminal which is marked with the letter E or by the earth symbol or coloured GREEN or GREEN/YELLOW.
- The BLUE wire is the NEUTRAL and must be connected to the terminal marked with the letter N or coloured BLACK.
- The BROWN wire is the LIVE wire and must be connected to the terminal marked with the letter L or coloured RED.



For Customer Services & Spare Parts please call **0345 208 8750**
Opening times: Monday - Friday 8am – 8pm & Saturday 9am – 1pm
or visit us at www.productcare.co.uk

Usage

Control panel

The appliance has an oven function dial, temperature dial, a display and function buttons, these are explained below:

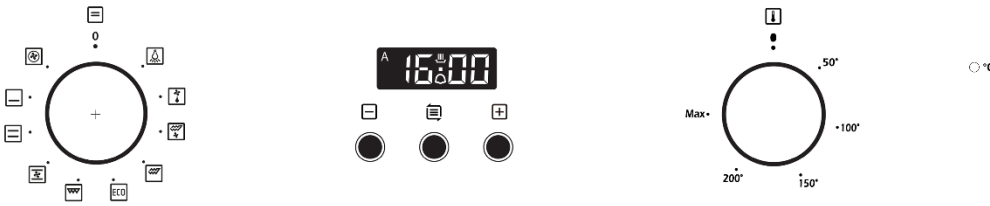



Oven function dial

The oven function dial allows you to set the oven function mode for the oven. The dial has to be pressed in for it to pop out, before it can then be rotated clockwise or anti-clockwise to set the required oven function.

When the required type of function is set, the oven light that is inside the oven lights up. The temperature dial will also need to be adjusted when using any of the oven functions except the oven lamp and defrost functions.







Note: The dial must be put in the off position after each use and depressed.

Note: Always pre-heat the oven to the required temperature before cooking.

Symbol	Function
	Oven Lamp: Turns on the oven lamp.
	Defrost: Circulates air in the oven at room temperature (without the use of any heat) enabling quicker thawing of frozen food. Use to defrost food only.





For Customer Services & Spare Parts please call **0345 208 8750**
Opening times: Monday - Friday 8am – 8pm & Saturday 9am – 1pm
or visit us at www.productcare.co.uk

Symbol	Function
	<p>Double grill with fan: The fan distributes the heated air around the food. The grill element and fan switch on and off alternately.</p> <p>Hot air grilling is particularly suitable for grilling fish, poultry and larger pieces of meat.</p>
	<p>Double grill: The whole area below the grill heating element becomes hot. The inner and outer grill elements are on.</p> <p>Can be used to grill a large number of burgers, sausages fish or bread.</p>
	<p>Eco: Energy-saving cooking mode where the fan distributes the heated air around the food that is emitted from the top, bottom and rear heating elements.</p> <p>Note: The oven light will not operate when this function is selected.</p> <p>Best suited for small amounts of food that are best cooked gently; bakes, meat dishes, vegetables, frozen pizza and biscuits. Not suitable for cakes and large amount of food.</p>
	<p>Single grill: Part of the area below the grill heating element becomes hot. The inner grill element is on.</p> <p>Can be used to grill a small number of burgers, sausages fish or bread.</p>
	<p>Convection heating with fan: The fan distributes the heated air around the food that is emitted by the top and bottom heating elements.</p> <p>Best suited for baking, roasting all meat, vegetables and pre-cooked meals.</p>
	<p>Top & bottom heating: Heat is emitted evenly from the top and bottom, which provides convectional cooking. The top and bottom elements work together to provide convectional cooking.</p> <p>Best suited for single items that are centred in the oven: cakes and pizzas on baking trays, and for lean joints of beef, etc.</p>



For Customer Services & Spare Parts please call **0345 208 8750**
 Opening times: Monday - Friday 8am – 8pm & Saturday 9am – 1pm
 or visit us at www.productcare.co.uk

Usage

Symbol	Function
	<p>Bottom heating: The temperature is emitted from below which provides heat to the base of food.</p> <p>Use bottom heating for baking and browning dishes from below, ideal for slow cooking dishes such as casseroles, stews, pastries and pizzas where a crispy base is desired.</p>
	<p>Convection heating: A fan with a ring heating element on the back of the oven ensures that the heated air is distributed evenly.</p> <p>You can bake cakes, pizza, biscuits, small cakes and puff pastry on two levels at the same time.</p>

Temperature dial

Use the temperature dial to set the required temperature for the oven. The dial has to be pressed in for it to pop out, before it can then be rotated clockwise to set the required temperature.

The temperature can set between 50°C and 250°C.

The small light next to the temperature dial will be lit when the oven is heating. It goes out during pauses in the heating. The oven function dial will also need to be adjusted; turning the temperature dial alone will not make the oven heat up.

Note: The dial must be put in the off position after each use and the dial depressed.

Display

This will show the time, icons and other values.



Oven on



Audible warning



Automatic mode set



For Customer Services & Spare Parts please call **0345 208 8750**
Opening times: Monday - Friday 8am – 8pm & Saturday 9am – 1pm
or visit us at www.productcare.co.uk

Usage

Function buttons

The buttons can be used to set additional functions.



Use this button to adjust the setting values downwards.



Use this button to set the different modes (press and hold for 3 seconds to turn the oven on: the symbol will appear on the display).



Use this button to adjust the setting values upwards.



The oven cavity

- The oven light is located in the cooking compartment. During oven operation, the oven light is on. By turning the function selector to any position, the oven light can also be switched on without the oven heating up.
- A cooling fan protects the oven from overheating.
- The cooling fan switches on and off as required. The hot air escapes above the door.
- So that the cooking compartment cools down more quickly after operation, the cooling fan continues to run for a certain period afterwards.
- There are supports either side of the compartment that accessories such as the wire shelf baking tray, etc. can be inserted in to.
- The coating of the oven cavity is enamel.
- Before you use the accessories for the first time, clean them with hot soapy water and a soft dish cloth.
- Clean all accessories by hand, do not clean in the dishwasher.



Russell Hobbs

For Customer Services & Spare Parts please call **0345 208 8750**
Opening times: Monday - Friday 8am – 8pm & Saturday 9am – 1pm
or visit us at www.productcare.co.uk

Usage

Warnings:

- When it is first used, it is normal for the oven to give off odours; this does not pose any risk and does not indicate a malfunction; they will disappear in time.



Setting the clock

When the oven is first connected to the electrical supply and powered on, the clock will need to be set. The display will automatically show the time as "12.30", there will be a single beep and the "." will flash.

Note: ensure the correct time is set before using the oven.

Note: the clock is a 24 hour clock, for example 2PM will be shown as 14.00.

To set the correct time of day

1. Press "+" or "-" button to adjust the hour setting.
2. Press the mode button  to confirm the hour setting.
3. Press "+" or "-" button to adjust the minute setting.
4. Press mode button  to confirm the minute setting and the timer will be go in to standby mode.

If the display does not flash, adjust the time by pressing and holding the "+" and "-" buttons at the same time for more than 3 seconds.





Russell Hobbs

For Customer Services & Spare Parts please call **0345 208 8750**
Opening times: Monday - Friday 8am – 8pm & Saturday 9am – 1pm
or visit us at www.productcare.co.uk

Usage



Modes

Important:

If the display does not show the  symbol the oven will not work or heat up. Only when the  symbol is visible will the oven function or heat up.

It is recommended that you run the oven for 15 minutes at 200 degrees to burn off any residue from their surfaces on first use.

Oven on and off

If the timer is in standby mode, press and hold the mode button  for more than 3 seconds. The timer will enter manual mode and the symbol  will light up on the display and will stay lit continuously (until turned off).

Time function setting

In manual mode, press the mode button  to access the time function settings. These are:

1. Manual mode - the cooking time is controlled by the user.

This mode is the default mode when the oven is taken out of standby.

2. Minute minder - you can set an audible warning for a completed time period.

Press the mode button once and a  symbol will be shown on the display (the oven will not turn off when the time period has finished).

3. Dur - you can set the oven so it will cook for a desired time range.

Press the mode button 2 times and “Dur” will be shown on the display.

4. End - you can set the oven so it will cook to a desired time

Press the mode button 3 times and “End” will be shown on the display.



Russell Hobbs

For Customer Services & Spare Parts please call **0345 208 8750**
Opening times: Monday - Friday 8am – 8pm & Saturday 9am – 1pm
or visit us at www.productcare.co.uk

Usage

Manual mode:

In manual mode, only the time and the symbol  will be shown on the display. The cooking duration has to be controlled by the user (the oven will run continuously until turned off).

To start cooking you need to **turn the oven function and temperature dials** to the required function and temperature. The oven light will turn on and the oven will start to heat up. Once the oven is preheated, carefully put the food that you wish to cook into the oven.

Note: In manual mode, if after 5 hours no button has been pressed the display on the oven will flash to warn you that it will turn off and automatically enter standby mode. After 10 hours the oven will automatically turn off and enter the standby mode. When the display is flashing in manual mode, press any button to continue using the oven. If you don't want to continue using the oven then turn the oven function and temperature dials to the off position. You can then if you wish put the oven in standby mode by pressing and holding the mode button  and the "+" buttons together for more than 3 seconds. The timer will now enter the standby mode.

Note: If you set 'Dur' or 'End' modes, then after cooking the oven will automatically turn off and enter the standby mode.











Russell Hobbs

For Customer Services & Spare Parts please call **0345 208 8750**
Opening times: Monday - Friday 8am – 8pm & Saturday 9am – 1pm
or visit us at www.productcare.co.uk

Usage

Minute minder (audible warning)

This function can be used to set an audible warning at the completion of the adjusted time period. Like the manual mode the cooking duration has to be controlled by the user (the oven will run continuously until turned off). To start cooking you need to **turn the oven function and temperature dials** to the required function and temperature. The oven light will turn on and the oven will start to heat up. Once the oven is preheated, carefully put the food that you wish to cook into the oven

1. To set the minute minder press the mode button  button once, the  symbol will then light up on the display and start to flash.
2. Press the " +" or "- " button and the hour figure will start to flash, to adjust the time press the " +" and "- " buttons.
3. Once the required hour time has been reached press the mode button  and the minute figures will start to flash, to adjust the time press the " +" and "- " buttons.
4. Once the required minute time has been reached press the mode button  to confirm the time and the  symbol will stop flashing and stay lit. The display will revert to clock time while the minute minder time counts down.
5. When the time is up, the timer will beep and the  symbol will flash on the display. Press and hold any button for 3 seconds to stop the beeping and the  symbol flashing.
6. The oven will continue to operate unless the oven function or temperature dials are turned to the off position or the oven is put in the standby mode (if you wish to put the oven in standby mode then press and hold the mode  and the "+" buttons together for more than 3 seconds).







For Customer Services & Spare Parts please call **0345 208 8750**
Opening times: Monday - Friday 8am – 8pm & Saturday 9am – 1pm
or visit us at www.productcare.co.uk

Usage

Dur (cook for a desired time period)

This function is used to cook for a desired time range (the maximum cooking period is 10 hours). To start cooking you need to **turn the oven function and temperature dials** to the required function and temperature. The food that is to be cooked needs to be put into the oven.

1. To set this mode, press the mode button  until "Dur" is shown on the display.
2. Press the "+" or "-" button and the hour figure and the "A" symbol will start to flash, to adjust the cooking time press the "+" and "-" buttons.
3. Once the required hour time has been reached press the mode button  and the minute figures will start to flash, to adjust the cooking time press the "+" and "-" buttons.
4. Once the required minute time has been reached press the mode button  to confirm the cooking time and the "A" symbol will stop flashing and stay lit. The oven will start to operate and the display will revert to clock time while time counts down.
5. When the cooking time has been reached, the oven will beep, the "A" symbol will flash on the display and the oven will automatically be turned off. Press and hold any button for 3 seconds to stop the beeping and the "A" symbol flashing.
6. If you wish to continue cooking then press and hold the mode button  for more than 3 seconds. The timer will enter manual mode and the symbol  will be shown on the display.
7. If you don't wish to continue cooking then turn the oven function and temperature dials to the off position.







Russell Hobbs

For Customer Services & Spare Parts please call **0345 208 8750**
Opening times: Monday - Friday 8am – 8pm & Saturday 9am – 1pm
or visit us at www.productcare.co.uk

Usage

End (cook to a desired time)

This function is used to cook according to a desired finishing time. To start cooking you need to **turn the oven function and temperature dials** to the required function and temperature. The food that is to be cooked needs to be put into the oven.

1. To set this mode, press the mode button  until "End" is shown on the display.
2. Press the "+" or "-" button and the hour figure and the "A" symbol will start to flash, to adjust the cooking time press the "+" and "-" buttons.
3. Once the required hour time has been reached press the mode button  and the minute figures will start to flash, to adjust the cooking time press the "+" and "-" buttons.
4. Once the required minute time has been reached press the mode button  to confirm the cooking time and the "A" symbol will stop flashing and stay lit. The oven will start to operate and the display will revert to clock time while time counts down.
5. When the cooking time has been reached, the oven will beep, the "A" symbol will flash on the display, and the oven will automatically turn off. Press and hold any button for 3 seconds to stop the beeping and the "A" symbol flashing.
6. If you wish to continue cooking then press and hold the mode button  for more than 3 seconds. The timer will enter manual mode and the symbol  will be shown on the display.
7. If you don't wish to continue cooking then turn the oven function and temperature dials to the off position.



Russell Hobbs

For Customer Services & Spare Parts please call **0345 208 8750**
Opening times: Monday - Friday 8am – 8pm & Saturday 9am – 1pm
or visit us at www.productcare.co.uk



Usage

Fully automatic programming (cook during a desired time range to a desired time)



This function is used to cook after a certain period of time, with a certain duration. To start cooking you need to **turn the oven function and temperature dials** to the required function and temperature.

The oven will start operating at the time calculated by deducting the cooking period from the set finishing time, and will stop at the set finishing time. For example if the current time is 13:00, the required cooking time is 1 hour and the required cooking end time is 18:00. The oven will start to operate 17:00 and end at 18:00.

Part 1

1. To set the cooking time period press the mode button  until "Dur" is shown on the display.
2. Press the "+" or "-" button and the hour figure will start to flash, to adjust the cooking time press the "+" and "-" buttons.
3. Once the required hour time has been reached press the mode button  and the minute figures will start to flash, to adjust the cooking time press the "+" and "-" buttons.
4. Once the required minute time has been reached press the mode button  to confirm the cooking time and the "A" symbol will stop flashing and stay lit.



Part 2

1. To set the cooking end time press the mode button  until "End" is shown on the display.
2. Press either the "+" or "-" button and the hour figure will start to flash, to adjust the cooking time press the "+" and "-" buttons.
3. Once the required hour time has been reached press the mode button  and the minute figures will start to flash, to adjust the cooking time press the "+" and "-" buttons.



For Customer Services & Spare Parts please call **0345 208 8750**
Opening times: Monday - Friday 8am – 8pm & Saturday 9am – 1pm
or visit us at www.productcare.co.uk

Usage

4. Once the required minute time has been reached press the mode button  to confirm the cooking time and the "A" symbol will stop flashing and stay lit. The  symbol will disappear from the display and the display will go to manual mode. The oven will start operating at the time calculated by deducting the cooking period from the set finishing time, and will stop at the set finishing time.
5. An audible warning will be given and the "A" symbol will begin to flash on the display when the set finishing time has been reached.
6. When the cooking time has been reached, the oven will beep, the "A" symbol will flash on the display and the oven will automatically be turned off. Press and hold any button for 3 seconds to stop the beeping and the "A" symbol flashing.
7. If you wish to continue cooking then press and hold the mode button  for more than 3 seconds. The timer will enter manual mode and the symbol will be shown on the display.
1. If you don't wish to continue cooking then turn the oven function and temperature dials to the off position.

Note: Once setting full-automatic mode, the time can only be changed by cancelling the programme and resetting it.





Russell Hobbs

For Customer Services & Spare Parts please call **0345 208 8750**
Opening times: Monday - Friday 8am – 8pm & Saturday 9am – 1pm
or visit us at www.productcare.co.uk

Usage

Tips

- Press the "+" or "-" buttons for more than 3 seconds to make the time rapidly increase or decrease.
- When setting the time for each function, if no button is pressed after 5 minutes then the oven will return to the manual mode
- When setting the time for each function, press the mode button  for more than 3 seconds will cancel the current setting and the oven will return to the manual mode.
- During time function setting, by pressing on the "+" and mode button  for more than 3 seconds the oven will beep, cancel the current function setting and be put into standby mode.

Energy saving

The following advice is to help you save energy:

- Only preheat the oven if this is specified in the recipe
- Open the oven door as infrequently as possible
- Use black enamelled baking trays, tins, etc. as they absorb the heat well.
- If you need to cook, bake or roast a number of different foods then it is best to do this one after the other. The oven will be at temperature, reducing the need to pre-heat the oven again.
- Cook more than 1 item at a time using the different accessories provided.



Russell Hobbs

For Customer Services & Spare Parts please call **0345 208 8750**
Opening times: Monday - Friday 8am – 8pm & Saturday 9am – 1pm
or visit us at www.productcare.co.uk

Usage

Accessories

Warning:

- **Correct placement of the shelves between the side supports is imperative. This will ensure that food does not fall off or slide out when in the oven or being carefully removed from the oven.**
- **Ensure that you always insert the accessories into the cooking compartment the right way round.**
- **Shelves and the universal tray only must be placed and used between the 5 side supports.**
- **The universal tray or any other kind of baking tray should not be placed on the bottom of the oven cavity.**

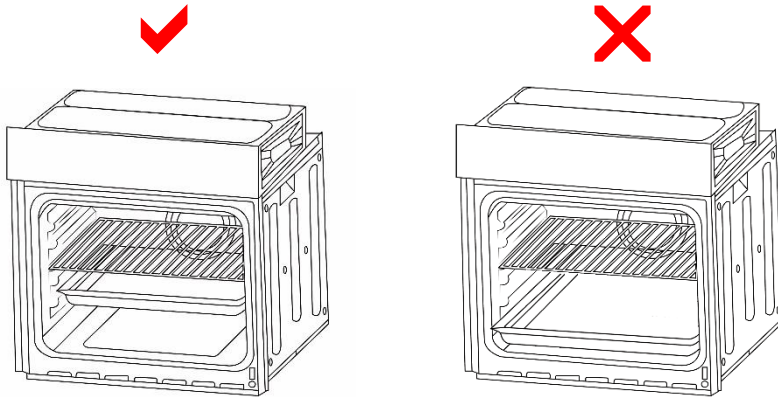

The accessories can be inserted in the oven at 5 different levels. Always insert the accessories as far as they can go to ensure that they do not touch the door glass.

Wire shelf - for ovenware, cake tins, roasts, grilling and frozen meals. Slide the wire rack into the oven with the raised part at the back and at the top.

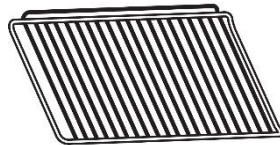

 **Russell Hobbs**

For Customer Services & Spare Parts please call **0345 208 8750**
Opening times: Monday - Friday 8am – 8pm & Saturday 9am – 1pm
or visit us at www.productcare.co.uk

Usage

Universal tray - for cooking large quantities of food such as cakes, pastries, frozen food, etc. Can also be used under the wire rack to catch fat when grilling. Slide the baking tray into the oven with the sloping edge facing towards the oven door.



Wire rack - for grilling and roasting. Place the wire insert in the universal tray with the legs facing downwards. This ensures that dripping fat and meat juices are collected.

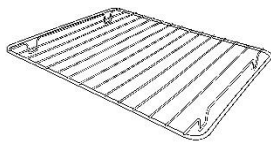

:



For Customer Services & Spare Parts please call **0345 208 8750**
Opening times: Monday - Friday 8am – 8pm & Saturday 9am – 1pm
or visit us at www.productcare.co.uk

Cleaning and Maintenance:

Important notes:

- The appliance will become hot during operation, allow the appliance to cool down before cleaning.
- Do not use any high-pressure cleaners or steam cleaners.
- Wash new sponge cloths thoroughly before use.
- Do not leave acidic substances (lemon juice, vinegar) on stainless steel parts.
- Follow all instructions and warnings included with the cleaning agents.

How to clean

Observe the information in the table below to ensure that the different surfaces are not damaged by using the wrong type of cleaning agent. **Do not use:**

- Harsh or abrasive cleaning agents,
- Cleaning agents with a high concentration of alcohol,
- Hard scouring pads or sponges,
- High-pressure cleaners or steam cleaners.
- Clean all accessories by hand, do not clean in the dishwasher.

Surface type	How to clean
Stainless Steel	Hot soapy water: Clean with a dish cloth and dry with a soft cloth. Clean stainless steel surfaces in the direction of the grain only. Special stainless steel cleaning products are available from specialist retailers. Apply a very thin layer of the cleaning product with a soft cloth.
Painted surfaces	Hot soapy water: Clean using a damp dish cloth and dry with a soft cloth/towel. Do not use any stainless steel cleaners.
Aluminium and plastic	Glass cleaner: Clean with a soft cloth.
Glass	Glass cleaner: Clean with a soft cloth. Do not use a glass scraper.
Enamel	Clean with some washing-up liquid and a damp cloth. Dry with a soft cloth.



For Customer Services & Spare Parts please call **0345 208 8750**
Opening times: Monday - Friday 8am – 8pm & Saturday 9am – 1pm
or visit us at www.productcare.co.uk

Cleaning and Maintenance:

How to clean:

- After each use, clean all surfaces once they have cooled down. If any residue is left (baked-on food, drops of grease etc.), however little, will become stuck to the surface and more difficult to remove later.
- Always clean off any liquid as soon as it is spilt: you will save yourself any unnecessary effort.
- Where possible, do not allow salt to come into contact with the surfaces of the appliance.

Causes of damage:

- **Accessories, foil, greaseproof paper or ovenware on the cooking compartment floor:** Do not place accessories on the cooking compartment floor. Do not cover the cooking compartment floor with any sort of foil or greaseproof paper. Do not place ovenware on the cooking compartment floor if a temperature of over 50°C has been set. This will cause heat to accumulate. The baking and roasting times will no longer be correct and the enamel will be damaged.
- **Water in a hot cooking compartment:** Do not pour water into the cooking compartment when it is hot. This will cause steam. The temperature change can cause damage to the enamel.
- **Moist food:** Do not store moist food in the cooking compartment when it is closed for prolonged periods. This will damage the enamel.
- **Fruit juice:** When baking particularly juicy fruit pies, do not pack the baking tray too generously. Fruit juice dripping from the baking tray leaves stains that cannot be removed. If possible, use the deeper universal pan.
- **Cooling with the appliance door open:** Only allow the cooking compartment to cool when it is closed. Even if the appliance door is only open a little, front panels of adjacent units could be damaged over time.



For Customer Services & Spare Parts please call **0345 208 8750**
Opening times: Monday - Friday 8am – 8pm & Saturday 9am – 1pm
or visit us at www.productcare.co.uk

Cleaning and Maintenance:

- **Very dirty door seal:** If the door seal is very dirty, the appliance door will no longer close properly when the appliance is in use. The fronts of adjacent units could be damaged. Always keep the door seal clean.
- **Never use the appliance door as a seat, shelf or worktop:** Do not sit on the appliance door, or place or hang anything on it. Do not place any cookware or accessories on the appliance door.
- **Inserting accessories:** accessories can scratch the door panel when closing the appliance door. Always insert the accessories into the cooking compartment as far as they will go.

Changing the bulb

If the bulb in the oven light fails, it must be replaced with a heat resistant 25 watt bulbs only. To replace the bulb follow the below steps:

Note: the oven lamp is located at the top right on the back of the oven.

1. Switch off the circuit breaker of the unit's mains outlet or fuse box.
2. Place a tea towel in the oven when it is cold to prevent damage.
3. Unscrew the glass cover by turning it anti-clockwise.
4. Replace the bulb with one of the same type.
5. Screw the glass cover back in.
6. Remove the tea towel and switch on the circuit breaker.

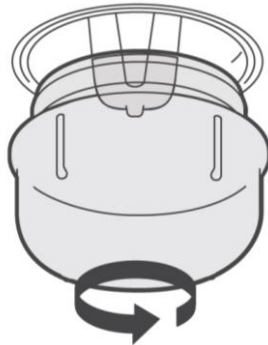

Russell Hobbs

For Customer Services & Spare Parts please call **0345 208 8750**
Opening times: Monday - Friday 8am – 8pm & Saturday 9am – 1pm
or visit us at www.productcare.co.uk

Trouble Shooting:

Problem	Solution
No power	The circuit break is defective or turned off check circuit breaker is in working order and that it is not switched off
	Power cut or faulty fuse Check whether other kitchen appliances are working or check in the fuse box to make sure that the fuse for the appliance is working
Functions are none responsive when turning the dials	The oven doesn't heat up Check the oven function and temperature dials have both been set
	The oven doesn't heat up Turn the control dials several times, as there may be dust between the connections
The clock flashes	There has been a power cut Reset the clock
Food is being burnt	Location of the shelves are incorrect or the cooking function that has been selected is incorrect Adjust the shelf locations and/or the cooking function that is being used



Russell Hobbs

For Customer Services & Spare Parts please call **0345 208 8750**
Opening times: Monday - Friday 8am – 8pm & Saturday 9am – 1pm
or visit us at www.productcare.co.uk

Guarantee

This product is guaranteed for 12 months from the date of the original purchase. If any defect arises due to faulty materials or workmanship you must contact Product Care with the original proof of purchase so a replacement or refund can be arranged.

Refund or replacement is at the discretion of Product Care.

The following conditions apply:

- Product Care will require a valid proof of purchase at the point of replacement or refund.
- The product must be installed and used in accordance with the instructions contained in this instruction guide and any other instructions for use which has been supplied.
- It must be used for domestic purposes only and for its intended use.
- This guarantee does not cover wear and tear, damage, misuse or consumable parts.

This does not affect your statutory rights.

Imported by
G2S LIMITED
WIGAN
WN2 4AY



For Customer Services & Spare Parts please call **0345 208 8750**
Opening times: Monday - Friday 8am – 8pm & Saturday 9am – 1pm
or visit us at www.productcare.co.uk

Technical Specification

Model number	RHEO6501B-M (SS-M)
Rated Voltage	220V – 240V ~ 50Hz
External Dimensions(HxWxD)	595mm x 595mm x 575mm



For Customer Services & Spare Parts please call **0345 208 8750**
Opening times: Monday - Friday 8am – 8pm & Saturday 9am – 1pm
or visit us at www.productcare.co.uk

Notes



For Customer Services & Spare Parts please call **0345 208 8750**
Opening times: Monday - Friday 8am – 8pm & Saturday 9am – 1pm
or visit us at www.productcare.co.uk

For Customer Services &
Spare Parts please call

0345 208 8750

Opening times:

Monday – Friday

8am – 8pm

&

Saturday

9am – 1pm

or visit us at

www.productcare.co.uk

CE



This symbol is known as the 'Crossed-out wheeie bin Symbol'. When this symbol is marked on a product/batteries, it means that the product/batteries should not be disposed of with your general household waste. Only discard electrical/electronic/battery items in separate collection schemes, which cater for the recovery and recycling of materials contained within. Your co-operation is vital to make sure the success of these schemes and for the protection of the environment. For your nearest disposal facility, visit www.recycle-more.co.uk or ask in store for details.

We reserve the right due to possible changes to design to alter the instruction manual without prior notice.

 **Russell Hobbs**

Revision 1