

Russell Hobbs RH50ETCEH2001B Owner's Manual

[Shop genuine replacement parts for Russell Hobbs
RH50ETCEH2001B](#)

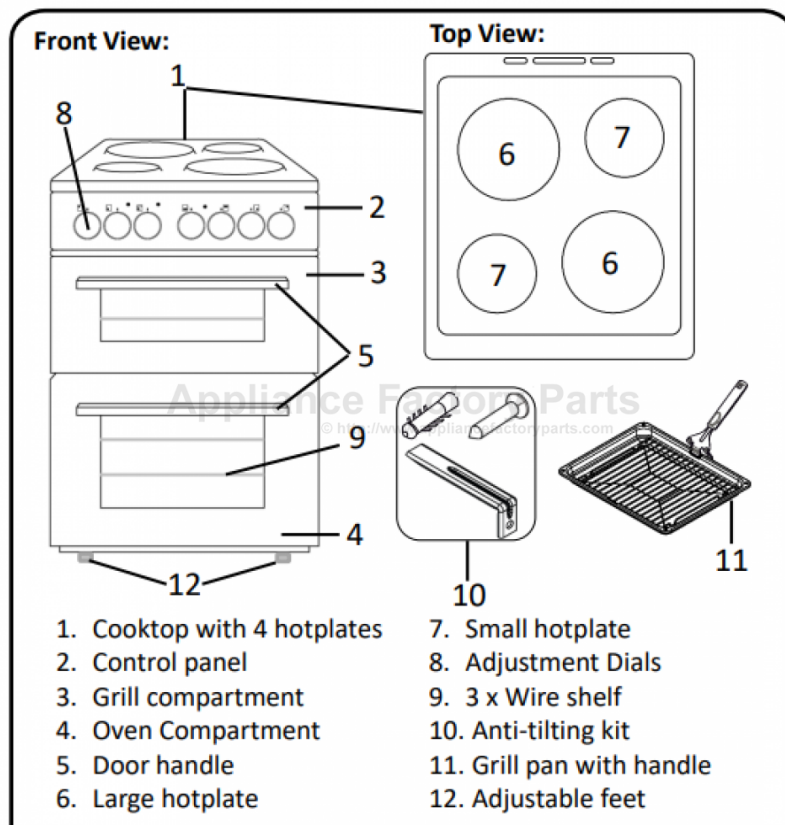

[Find Your Russell Hobbs Cooker Parts - Select From 29 Models](#)

----- Manual continues below -----



Russell Hobbs

At the heart of your home

Multifunction Electric Fan Double Oven Instruction Manual

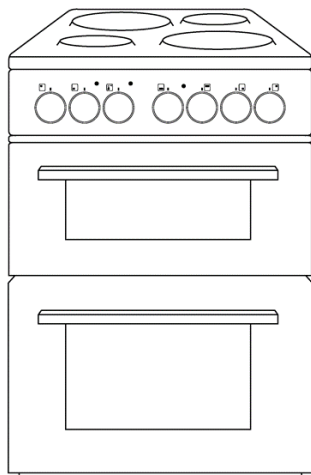

**Model number:
RH50ETCEH2001B**

For Customer Services & Spare Parts please call **0345 208 8750**
or visit us at <https://mda.russellhobbs.com>

**IMPORTANT:
RETAIN FOR FUTURE REFERENCE**

CONTENTS

	Page(s)
Safety instructions	3-7
Installation & Positioning	8-13
Product Overview	14
How To Use Your Oven	15-22
Cleaning & Maintenance	23-28
Trouble shooting	29-30
Guarantee	31
Product Information	32
Disposal information	32
Notes	33
Customer Service Information	34

SAFETY INSTRUCTIONS

Important Note:

Please read this booklet before installing and switching on this appliance. The manufacturer assumes no responsibility for incorrect installation and usage as described in this booklet.

This appliance can be used by children aged from 8 years and above and persons with reduced physical, sensory or mental capabilities or lack of experience and knowledge if they have been given supervision or instruction concerning use of the appliance in a safe way and understand the hazards involved. Children shall not play with the appliance.

Electric ovens and hobs must be hard-wired to a suitably rated electrical cooker power point – it is recommended that you consult a qualified electrician. Failure to do so will invalidate your guarantee, liability claims, and could lead to criminal prosecution.

- Children should be supervised to ensure that they do not play with the appliance. Please keep children and animals away from this appliance.
- If the supply lead is damaged it must be replaced by a qualified person using the correct lead, which is available from our customer helpline on **0345 208 8750**.
- Packaging material is dangerous to children. Never allow children to play with packaging material.
- Check the appliance for damage after unpacking it. Do not connect the appliance if it has been damaged in transport.
- The appliance can only be used safely if it is correctly installed according to the safety instructions. The installer is responsible for ensuring that the appliance works correctly after installation.
- All operations relating to installation and regulation must be carried out by an authorised installation engineer, respecting applicable regulations, standards and the specifications of the local electricity providers.

SAFETY INSTRUCTIONS

- This appliance can only be installed in a well-ventilated place in accordance with existing regulations and ventilation specifications.
- This appliance is intended for domestic use and the household environment only. The appliance is not intended for use outside.
- Do not tamper with the appliance's interior. If necessary, call our customer helpline.
- Do not switch on the appliance if it is damaged in any way. Contact our customer helpline at the number on the front of the booklet.
- This appliance is only intended for cooking purposes, not as a heating system.
- The manufacturer is not liable for damage which is caused by improper use or incorrect operation.
- Combustible items stored in or on top of the appliance may catch fire. Never store combustible items in or on top of the appliance. Never open the appliance doors if there is smoke inside. Switch off the appliance and unplug it from the mains or switch off the circuit breaker in the fuse box.
- A draught is created when the appliance doors are opened. Greaseproof paper may come into contact with the heating element and catch fire. Do not place greaseproof paper loosely over accessories during preheating. Always weigh down greaseproof paper with a dish or a baking tin. Only cover the surface required with greaseproof paper. Greaseproof paper must not protrude over the accessories.
- Always slide accessories into the cooking compartment.
- The appliance and its accessible parts become very hot when in operation. Never touch the interior surfaces of the cooking compartments or the heating elements while hot. Always allow the appliance to cool down first. Keep children at a safe distance.
- Accessories and ovenware become very hot. Always use oven gloves to remove accessories or ovenware from the cooking compartment.
- Shelves must only be placed and used between the side supports.
- The grill pan must only be placed on the shelves.

SAFETY INSTRUCTIONS

- The grill pan or any other kind of baking tray should not be placed on the bottom of the oven cavities.
- Alcoholic vapours may catch fire in the hot cooking compartments. Never prepare food containing large quantities of drinks with a high alcohol content. Only use small quantities of drinks with a high alcohol content. Open the appliance doors with care.
- When you open the appliance doors, hot steam may escape. Open the appliance doors with care. Keep children at a safe distance.
- Water in a hot cooking compartment may create hot steam. Never pour water into the hot cooking compartments.
- Scratched glass in the appliance doors may develop into a crack. Do not use a glass scraper, sharp or abrasive cleaning aids or detergents when cleaning your appliance. Never use strong and abrasive cleaning agents as they will cause surface damage.
- The appliance gets hot. Do not keep combustible objects or aerosol cans in drawers and cupboards directly besides the appliance.
- A defective appliance may cause electric shock. Never switch on a defective appliance. Disconnect the appliance from the mains or switch off the circuit breaker in the fuse box. Contact the customer services.
- The cable insulation on electrical appliances may melt when touching hot parts of the appliance. Never bring electrical appliance cables into contact with hot parts of the appliance.
- Penetrating moisture may cause an electric shock. Do not use any high pressure cleaners or steam cleaners.
- When replacing the cooking compartment bulb, the bulb socket contacts are live. Before replacing the bulb, disconnect the appliance from the mains or switch off the circuit breaker in the fuse box.
- Incorrect repairs are dangerous. Repairs may only be carried out by a qualified electrician.
- In the event of a malfunction, turn off the appliance's electricity supply. For repairs, call customer services.
- Carrying the appliance: do not carry or hold the appliance by the door handles. Please use the handles present on the side casing.

SAFETY INSTRUCTIONS

- This cooker is intended for heating food and beverages only. The drying of food or clothing, and heating of warming pads, wheat bags, slippers, sponges, damp cloths and similar is extremely dangerous & may lead to risk of injury, ignition or fire.
- **Never** put objects into the openings on the outer case.
- Food containing a mixture of fat and water (e.g. stock), should stand for 30 to 60 seconds in the oven after it has been turned off. This is to allow the mixture to settle and to prevent it from bubbling when a spoon is placed in it, or a stock cube is added.
- When heating or cooking food or liquid, remember that there are certain foods (such as jam, Christmas pudding, and mincemeat), which heat up very quickly.
- Do not cook any food surrounded by a membrane in the oven cavities, such as egg yolks, potatoes, chicken livers,sausages, ready meals and so on without piercing them several times with a fork.
- Do not overcook food.
- When heating food in plastic or paper containers, keep an eye on the oven due to the possibility of ignition.
- If materials inside the oven smoke or catch fire, keep the oven doors closed to stifle the flames, and turn the oven off at the wall switch or shut the power off at the fuse or circuit-breaker panel. If smoke is emitted , switch off or unplug the appliance and keep the doors closed in order to stifle any flames.
- Please remember that as food or liquids heat up, they will release steam or may be spitting. Never cover any container fully, always leave a gap for steam to escape.
- Do **not** use plastic containers when heating or cooking foods that contain a lot of fat or sugar.
- When using the shelves and baking tray, be aware that these will become HOT during cooking as they aren't heatproof. Please use suitable oven gloves when removing these.
- **WARNING:** Danger of fire - Do not store items on the cooking surfaces.

SAFETY INSTRUCTIONS

WARNING: The appliance and its accessible parts become hot during use. Care should be taken to avoid touching heating elements. Keep children less than 8 years of age away unless they are continually supervised.

WARNING: Unattended cooking on a hob with fat or oil can be dangerous and may result in fire. **NEVER** try to extinguish such a fire with water. Instead, switch off the appliance and cover the flame with a lid or a fire blanket.

WARNING: If the hob surface is cracked, switch off the appliance to avoid the possibility of electric shock.

- Do not operate the appliance with an external timer or separate remote-control system.
- Under no circumstances should the oven be lined with aluminium foil as overheating may occur.
- Always position pans over the centre of the cooking zone, and turn the handles to a safe position so they cannot be knocked.
- Make sure the appliance control knobs are always in the "0" (stop) position when the appliance is not in use.
- The trays incline when pulled out. Take care not to spill or drop hot food when removing it from the oven.
- Do not remove the control knobs to clean the control panel.
- To maintain the efficiency and safety of your appliance, we recommend you always use original spare parts and to call our authorised service agents when needed.

WARNING: To prevent the appliance tipping, the stabilising brackets must be installed. (For detailed information refer to the anti-tilting kit set guide.)

- Before connecting your appliance, make sure that the local distribution conditions (electricity voltage and frequency) and the specifications of the appliance are compatible. The specifications for this appliance are stated on the label.

INSTALLATION & POSITIONING

Preparation & Installation

WARNING : This appliance must be installed by an authorised service person or qualified technician, according to the instructions in this guide and in compliance with the current local regulations.

WARNING : Ensure that there are no electric wires, gas or water pipes in the area where holes are to be made.

WARNING : Components of the appliance may have sharp edges. Wear protective gloves.

Preparing for installation:

- After removing the packaging material from the appliance and its accessories, ensure that the appliance is not damaged. If you suspect any damage, do not use it and contact an authorised service person or qualified technician immediately.
- Make sure that there are no flammable or combustible materials in the close vicinity, such as curtains, oil, cloth etc. which may catch fire.
- The worktop and furniture surrounding the appliance must be made of materials resistant to temperatures above 100°C.
- The appliance should not be installed directly above a dishwasher, fridge, freezer, washing machine or clothes dryer.
- The appliance can be placed close to other furniture on condition that, in the area where the appliance is set up, the furniture's height does not exceed the height of the cooktop.

Electrical Connection Instructions:

WARNING : This appliance must be installed by an authorised service person or qualified technician, according to the instructions in this guide and in compliance with the current local regulations.

INSTALLATION & POSITIONING

WARNING : THIS APPLIANCE MUST BE EARTHED.

- Before connecting the appliance to the power supply, the voltage rating of the appliance (marked on the rating label) must be checked for correspondence to the available mains supply voltage, and the mains electric wiring should be capable of handling the appliance's power rating (also marked on the rating label).
- During installation, please ensure that isolated cables are used. An incorrect connection could damage your appliance. If the mains cable is damaged and needs to be replaced this should be done by a qualified personnel.
- Do not use adaptors, multiple sockets and/or extension leads.
- The supply cord should be kept away from hot parts of the appliance and must not be bent or compressed. Otherwise the cord may be damaged, causing a short circuit.
- If the appliance is not connected to the mains with a plug, an all-pole disconnecter (with at least 3 mm contact spacing), must be used in order to meet the safety regulations.
- The appliance is designed for a power supply of 220-240 Vac. If your supply is different, contact the authorized service personnel or qualified electrician.
- The power cable (H05VV-F) must be long enough to be connected to the appliance.
- The fused switch must be easily accessible once the appliance has been installed.
- Ensure all connections are adequately tightened.
- Fix the supply cable in the cable clamp and then close the cover.
- The terminal box connection is placed on the terminal box.

ENSURE THE WIRES ARE CONNECTED ACCORDING TO BELOW:

Green/Yellow (Earth) wire to the terminal marked "PE".
Brown (Live) wire to the terminal marked "L".
Blue (Neutral) wire to the terminal marked "N".

- For this connection, a 'Twin and Earth 6242Y' type cable should be used.

INSTALLATION & POSITIONING

WARNING : THIS APPLIANCE MUST BE EARTHED.

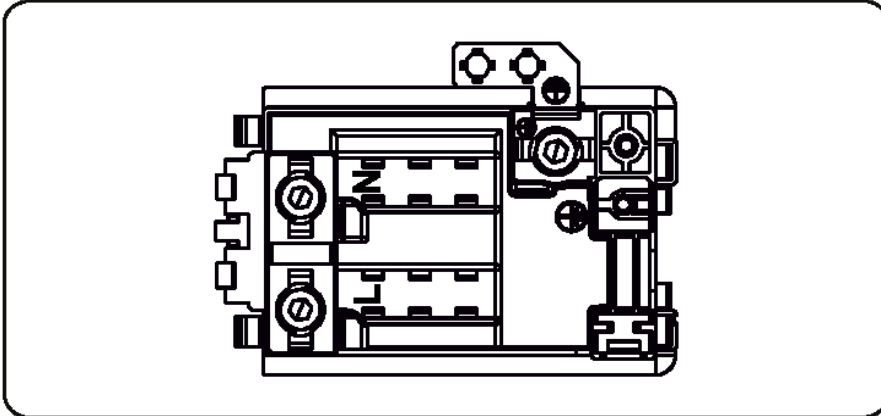

Green/Yellow (Earth) wire to the terminal marked "PE".

Brown (Live) wire to the terminal marked "L".

Blue (Neutral) wire to the terminal marked "N".

INSTALLATION

Installing the appliance:

1. Ensure that there will be an electrical power point within adequate distance of the oven after it has been installed.
2. Ensure the space where the appliance will be situated measures at least (W)495 x (D)650mm, and is in compliance with the instructions on the previous page.
3. Install the anti-tilting bracket to the wall following the directions given on the next page, and then carefully and gently put the oven into the space, making sure that the power cable can still be accessed.
4. Connect the oven to the electrical power point before attaching the oven to the anti-tilting bracket fully. Your oven is now installed.

NOTE:

- If the kitchen furniture is higher than the cooktop, the kitchen furniture must be at least 10 cm away from the sides of appliance for air circulation.
- If a cooker hood or cupboard is to be installed above the appliance, the safety distance between cooktop and any cupboard/cooker hood should be as shown below.

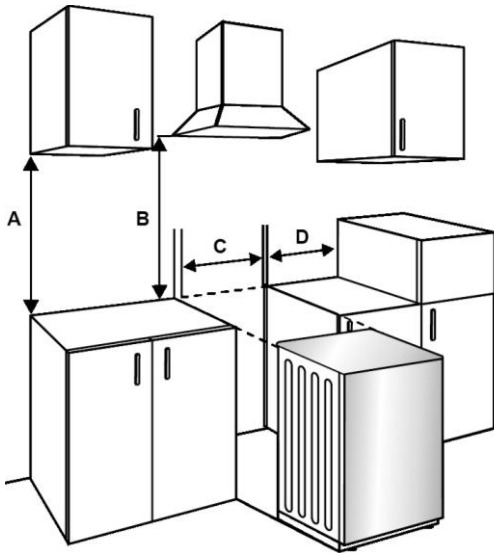

A (mm) Cupboard	420
B (mm) Cooker Hood	650/700
C (mm) Product Width	495
D (mm)	50

INSTALLATION & POSITIONING

Anti-Tilting Kit:

- The appliance comes with an anti-tilting kit in the document bag.
- This is to ensure that the oven is secure and will not fall over due to poor balance.
- Loosely attach the anti-tilting bracket (1) to the wall using the screw (2) and wall plug (3), following the measurements and directions shown below.

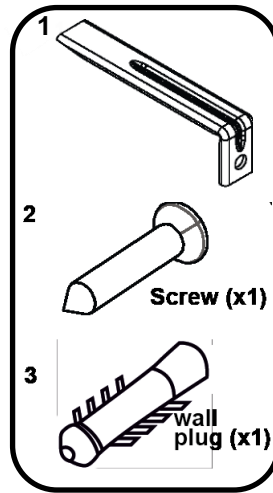

Directions:

1. Adjust the height of the anti-tilting bracket so that it lines up with the slot on the cooker and tighten the screw.
2. Push the appliance towards the wall making sure that the anti-tilting bracket is inserted into the slot on the rear of the appliance.

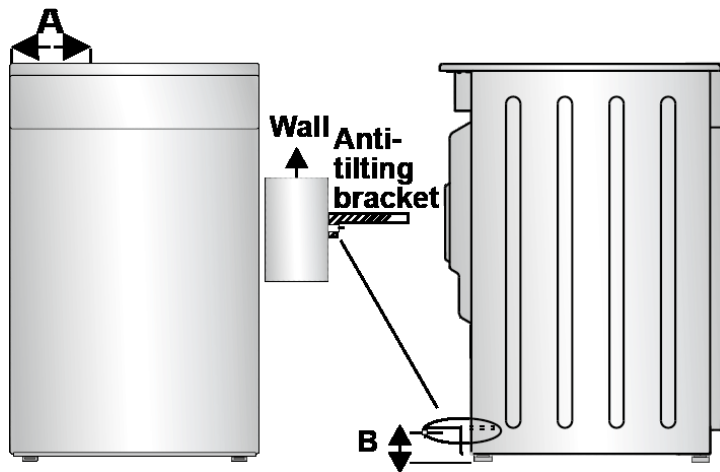

A (mm)	247.5
B (mm)	52

INSTALLATION & POSITIONING

Adjusting the Feet:

- Your product stands on four adjustable feet.
- For safe operation, it is important that your appliance is correctly balanced.
- Make sure the appliance is level prior to cooking.
- To increase the height of the appliance, turn the feet anti-clockwise. To decrease the height of the appliance, turn the feet clockwise (as seen in the diagram below).

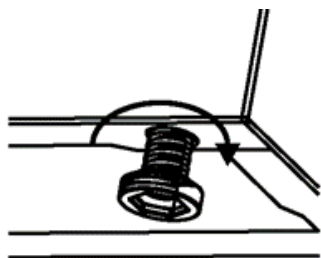

- It is possible to raise the height of the appliance up to 30 mm by adjusting the feet.
- The appliance is heavy and we recommend that a minimum of 2 people lift it.
- Never drag the appliance.

PRODUCT OVERVIEW

Front View:

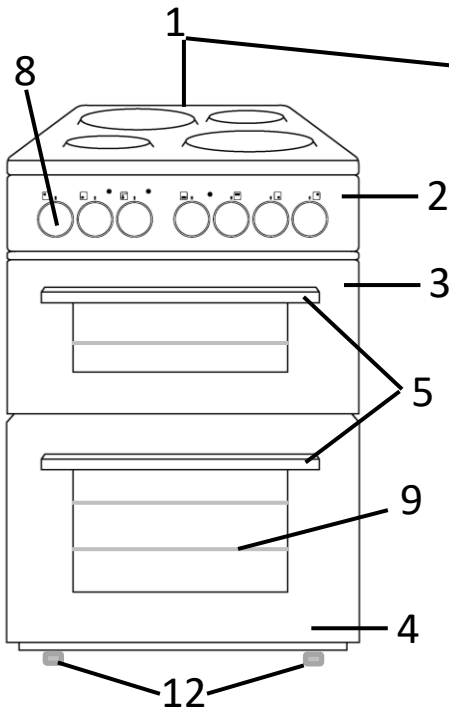

Top View:

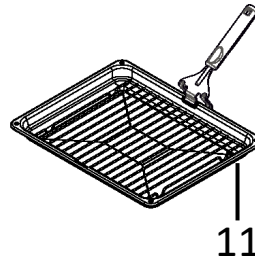
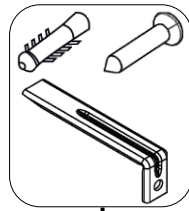
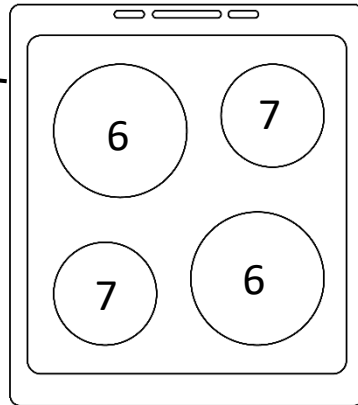

- | | |
|-----------------------------|---------------------------|
| 1. Cooktop with 4 hotplates | 7. Small hotplate |
| 2. Control panel | 8. Adjustment Dials |
| 3. Grill compartment | 9. 3 x Wire shelf |
| 4. Oven Compartment | 10. Anti-tilting kit |
| 5. Door handle | 11. Grill pan with handle |
| 6. Large hotplate | 12. Adjustable feet |

Unit & Spare Parts









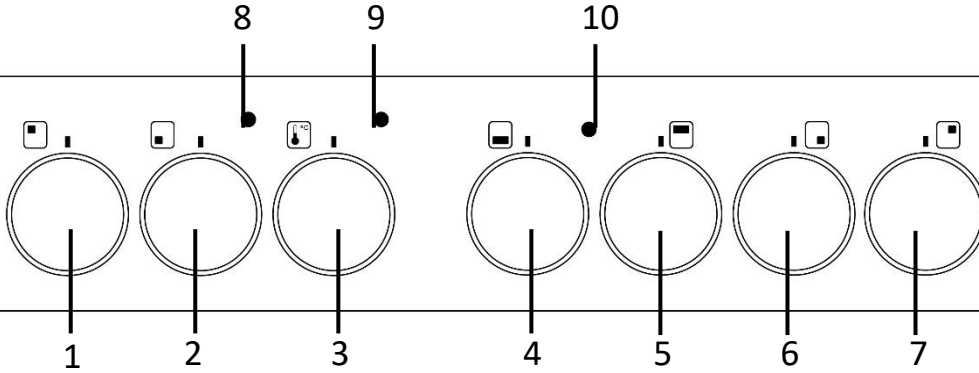

If any of the above parts are missing please contact the customer service team on 0345 208 8750 or visit <https://mda.russellhobbs.com>

HOW TO USE YOUR OVEN

Control Panel

The appliance has seven dials. See explanations below:



1	 Top Left Hotplate Dial	Turn to change the temperature of the hotplate
2	 Bottom Left Hotplate Dial	Turn to change the temperature of the hotplate
3	 Oven Temperature Dial	Dial to alter the temperature of the oven
4	 Oven Function Dial	Dial to change the function of the oven
5	 Grill Cavity Dial	Turn to change the grill temperature
6	 Bottom Right Hotplate Dial	Turn to change the temperature of the hotplate
7	 Top Right Hotplate Dial	Turn to change the temperature of the hotplate
8	 Hotplate Warning Light	This will be lit whenever any of the hotplates are switched on, or if they are still hot after use
9	 Oven Cavity Warning Light	Light will be on when function and temperature has been set
10	 Grill Cavity Warning Light	Light will be on when the grill is on

HOW TO USE YOUR OVEN

Hotplates

- The hotplates are controlled by dials with 6 positions, and can be operated by switching a control dial to one of these positions.
- Near each hob control dial, there is a small symbol that shows which hotplate is controlled by that dial.
- Please follow the chart below to advise what position to turn a dial to for cooking different foods:

Knob Position	Function
0	Off position
1	To melt butter etc. and to warm small quantities of liquid
2	To warm bigger quantities of liquid & to prepare creams and sauces
3	To defrost food for cooking
4	To cook delicate meat and fish
5	To roast meat and steak
6	To boil big quantities of liquid or to fry

WARNING: When operating the hotplate for the first time, or after it has not been used for a prolonged period of time, it is necessary to eliminate any humidity which may have accumulated around the electrical elements of the plate. To do this, operate the hotplate on its lowest setting for about 20 minutes.

WARNING: Never operate a hotplate without pans on. Otherwise, form defects may occur on the cooktop.

WARNING: Only use flat-bottomed pans with thick bases.

WARNING: Make sure the bottom of the pan is dry before placing it on a hotplate.

HOW TO USE YOUR OVEN

WARNING: When a hotplate is in operation, make sure that the pan is centred correctly on it.

- Never use a pan with a smaller or larger diameter than that of the hotplate as this will waste energy.
- If possible, always place lids on the pans to avoid heat loss.
- The temperature of accessible parts may become high while the appliance is operating. It is imperative to keep children and animals well away from the hob during use and until it has fully cooled after use.

WARNING: If you notice a crack on the cooktop, it must be immediately switched off and replaced by an authorized service personnel or technician.

WARNING: When it is first used, the oven may give off odours; this does not pose any risk and does not indicate a malfunction. They will disappear in time. This is perfectly normal and is caused by the insulation materials on the heating elements. We suggest that, before using your oven for the first time, you leave it empty and set it at maximum temperature for 45 minutes. Make sure that the environment in which the product is installed is well ventilated.

Top Oven Cavity

- The top oven cavity is the grill compartment, and is controlled by the dial labelled 5 (page 14).
- This compartment can be used to grill bacon, sausages, or bread etc.
- The dial goes from 0 (off position), to 6 (highest grilling temperature).
- **NOTE:** The top oven door must be fully open when this function is selected.
- When the grill is on, the warning light labelled 10 (page 14), will be switched on.
- This cavity does not contain an internal oven light.
- There are side rack supports either side of the compartment that accessories such as the wire shelves, grill tray, etc. can be inserted in to.
- The coating of the oven cavity is enamel.
- Before you use the oven and the accessories for the first time, clean them with hot soapy water and a soft dish cloth. Clean all accessories by hand, do not clean in the dishwasher.

HOW TO USE YOUR OVEN

Bottom Oven Cavity

- The bottom oven cavity has 3 different functions available, which are listed and explained in table on the next page. These can be set by turning the dial labelled 4 (page 14).
- Once the function has been selected, you can alter the temperature using the dial labelled 3 (page 14).
- Once a mode and its relative temperature have been selected, the warning light labelled 9 (page 14), will be switched on.
- The oven will start to heat up and the light will turn off when the temperature inside has reached the temperature that has been selected.
- Depending on what function is selected, the oven has a different temperature range e.g. the defrost function has a set temperature in order to not cook your food, but with the fan function, the temperature can be amended to your preference.
- An oven light is located in the cooking compartment. The light turns on automatically when an oven function has been selected.
- A cooling fan protects the oven from overheating. The cooling fan switches on and off as required.
- So that the cooking compartment cools down quickly after operation, the cooling fan continues to run for a certain period afterwards.

Note: Always pre-heat the oven to the required temperature before cooking.

Making Changes During Cooking

- It is possible to change the heating mode and temperature during cooking. Simply turn the oven function dial to change the programme, or turn the temperature adjustment dial to change the temperature. After the changes have been made, the oven will cook at the changed function and temperature. However in order to have the best cooking results, we recommend to choose the right settings at the beginning, prior to cooking.

HOW TO USE YOUR OVEN



Types of Heating Modes

This oven has a number of modes. Below is an overview to enable you to find the suitable heat settings required for certain dishes/cooking.

Top Oven Cavity:

Symbol	Temperature Range	Function
	Dial goes from 1 to 6	<p>Grill: The whole area below the grill heating element becomes hot. Top oven door must be fully open for this function to work.</p> <p>This function can be used to grill burgers, bacon, sausages, fish or bread.</p>

Bottom Oven Cavity:

Symbol	Temperature Range	Function
	50°C - 220°C	<p>Convection Heating: Turn the bottom oven control dial past the defrost symbol to use this function. The fan distributes the heated air that is emitted by the rear heating elements around the food. Preheating the oven for 10 minutes is recommended.</p> <p>This function is best suited for baking, roasting all meat, vegetables, and pre-cooked meals.</p>
	-	<p>Defrost: Turn the bottom oven control dial to the defrost symbol. This function circulates air in the oven at room temperature (without the use of any heat) enabling quicker thawing of frozen food. Place your frozen food on a shelf in the middle of the oven. Place an oven tray under your defrosting food to catch the accumulated water.</p> <p>Use this to defrost food only.</p>

HOW TO USE YOUR OVEN

Accessories

WARNING:

- **Correct placement of the shelves between the side supports is imperative. This will ensure that food does not fall off or slide out when in the oven or being carefully removed from the oven.**
- **Ensure that you always insert the accessories into the cooking compartment the right way round.**
- **Shelves and the grill pan must only be placed and used between the side supports.**
- **The grill pan or any other kind of baking tray should not be placed on the bottom of the oven cavity.**

The accessories can be inserted in the oven at 5 different levels, and in the grill cavity at 2 different levels. Always make sure that the accessories are inserted properly, orientated correctly, and are not touching the oven door.

Wire Shelf – Use for ovenware, cake tins, roasts, grilling, and frozen meals. Slide the wire rack into the oven with the raised part at the back and at the top.



HOW TO USE YOUR OVEN

The wire shelves can be pulled out halfway until they are locked in place. The locking function prevents the shelves from tilting when they are pulled out. The wire shelves must be inserted into the cavity correctly to avoid tilting. When inserting the wire rack, please make sure the wire rack is as shown on the illustration below.

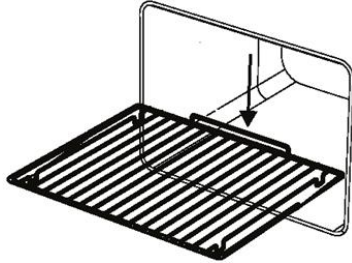

Grill Pan and Handle – Use for grilling steaks and similar foods, such as bacon and sausages. You can also use this for toasting bread, and broiling dishes to brown the top of them e.g. pasta bake, cheese on toast etc. The grill pan can also be used under the wire racks in the oven to catch fat from food while cooking.

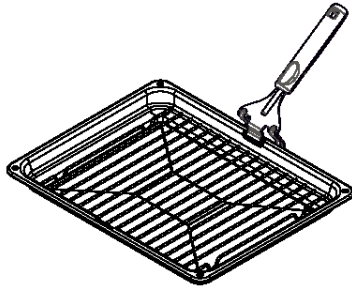

WARNING:

- **DO NOT** place the grill pan on the bottom of the oven cavities. Always place the grill pan on top of a wire rack to use.
- The grill pan has a detachable handle. Make sure that when using the grill pan handle that it is centralised and secure, as shown in the figure above. **DO NOT** leave the handle in position while grilling is in operation.

HOW TO USE YOUR OVEN

Energy Saving

The following advice is to help you save energy.

When using your oven:

- Only preheat the oven if this is specified in the recipe.
- Keep the pre-heating time short.
- Open the oven door as infrequently as possible.
- Use black enamelled baking trays, tins etc., as they absorb the heat well.
- If you need to cook, bake, or roast a number of different foods then it is best to do this one after the other. The oven will be at temperature, reducing the need to pre-heat the oven again.
- Cook more than 1 item at a time using the different accessories provided.
- Do not overcook your food; it only elongates your cooking time.
- Remember to turn off the oven at the end of cooking.

When using your hob:

- Use cookware that has a flat base, as this distributes heat to your food quickly and more evenly.
- Use the appropriate size hob ring for the size of your pan e.g. do not use the large hob ring for a small pan. This only wastes energy.
- Use a lid on your cookware to keep in heat.
- Minimise the amount of liquid or fat in your cooking.
- If you're heating liquids on the hob, once the liquid starts to boil, reduce the heat setting.

CLEANING & MAINTENANCE

Important Notes:

- The appliance will become hot during operation, so allow the appliance to cool down before cleaning.
- Do not use any high-pressure cleaners or steam cleaners.
- Wash new sponge cloths thoroughly before use.
- Do not leave acidic substances (e.g. lemon juice, vinegar), on stainless steel parts.
- Do not clean the stainless steel parts while they are still hot from cooking.
- Do not use cleaners that contain particles, as they may scratch the glass, enamelled and/or painted parts of your appliance.
- Follow all instructions and warnings included with the cleaning agents.

How to Clean

Observe the information in the table below to ensure that the different surfaces are not damaged by using the wrong type of cleaning agent. Clean all accessories by hand, do not clean in the dishwasher.

Do not use:

- Harsh or abrasive cleaning agents.
- Cleaning agents with a high concentration of alcohol.
- Hard scouring pads or sponges.
- High-pressure cleaners or steam cleaners.
- Cream or liquid cleaners that contain particles.

Surface Type	How to Clean
Stainless Steel	Use hot water and clean with a dish cloth and dry with a soft cloth. Clean stainless steel surfaces in the direction of the grain only. Special stainless steel cleaning products are available from specialist retailers. Apply a very thin layer of the cleaning product with a soft cloth.
Painted Surfaces	Use hot soapy water and clean using a damp dish cloth and dry with a soft cloth/towel. Do not use any stainless steel cleaners.
Aluminium and Plastic	Use glass cleaner and clean with a soft cloth.
Glass	Use glass cleaner and clean with a soft cloth. Do not use a glass scraper.
Enamel	Clean with some washing-up liquid and a damp cloth. Dry with a soft cloth.

CLEANING & MAINTENANCE

How to Clean:

- To clean the hotplates, wait until they have cooled. Then, wipe the hotplate with a soft cloth soaked in water, and then run the hotplate for a short time to dry it completely.
- After each use, clean all surfaces once they have cooled down. If any residue is left (baked-on food, drops of grease etc.), however little, it will become stuck to the surface and more difficult to remove later.
- Always clean off any liquid as soon as it is spilt. You will save yourself any unnecessary effort.
- Where possible, do not allow salt to come into contact with the surfaces of the appliance.

Causes of Damage:

- **Accessories, foil, greaseproof paper or ovenware on the cooking compartment floor:** Do not place accessories on the cooking compartment floors. Do not cover the cooking compartment floors with any sort of foil or greaseproof paper. Do not place ovenware on the cooking compartment floors if a temperature of over 50°C has been set. This will cause heat to accumulate. The baking and roasting times will no longer be correct and the enamel will be damaged.
- **Water in a hot cooking compartment:** Do not pour water into the cooking compartments when they are hot. This will cause steam. The temperature change can cause damage to the enamel.
- **Moist food:** Do not store moist food in the cooking compartments when it is closed for prolonged periods. This will damage the enamel.
- **Fruit juice:** When baking particularly juicy fruit pies, do not pack the baking tray too generously. Fruit juice dripping from the baking tray leaves stains that cannot be removed. If possible, use the deeper universal pan.
- **Cooling with the appliance door open:** Only allow the cooking compartments to cool when it is closed. Even if the appliance doors are only open a little, front panels of adjacent units could be damaged over time.

CLEANING & MAINTENANCE

- **Very dirty door seal:** If the door seals are very dirty, the appliance doors will no longer close properly when the appliance is in use. The fronts of adjacent units could be damaged. Always keep the door seals clean.
- **Never use the appliance hob as a seat, shelf, or worktop:** Do not sit on the hob, or store anything on it when it is not in use.
- **Never use the appliance door as a seat, shelf, or worktop:** Do not sit on the appliance door, or place or hang anything on it. Do not place any cookware or accessories on the appliance door.
- **Inserting accessories:** Accessories can scratch the door panels when closing the appliance doors. Always insert the accessories into the cooking compartments as far as they will go.

Changing the Bulb

WARNING: The maintenance of this appliance should be carried out by an authorised service person or qualified technician **ONLY**.

WARNING: Switch off the appliance and allow to cool before any maintenance is performed on the appliance.

- Ensure that the oven is turned off at the mains prior to changing the bulb.
- The replacement bulb must be resistant to at least 300 °C, (Specification: 230 V, 15-25 Watt, Type E14).
- Remove the glass lens, then remove the bulb.
- Insert the new bulb to replace the bulb that you removed.
- Replace the glass lens, and your oven is ready for use.

Important Note: The lamp is designed specifically for use in household cooking appliances. It is not suitable for household room illumination.

CLEANING & MAINTENANCE

Removing the Door

Before you can deep clean the oven glass door, you must remove the oven door by following the steps below.

1. Open the door fully, you will see the door hinges on either side of the door. The hinges have locking levers which will be in the closed position.

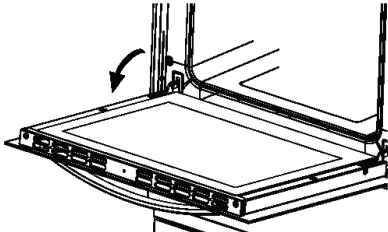

2. Open the locking catch (a) with the aid of a screwdriver. Open it up to the end position.

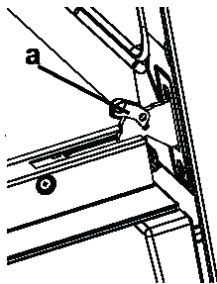

3. Still supporting the door, partly close the door until you feel resistance. Then holding the door on both sides, pull it up and outwards to detach the door from the oven.

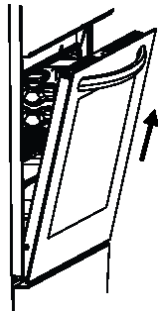

CLEANING & MAINTENANCE

Door Assembly

To reattach the door, please follow the below steps:

1. When installing the door, you must make sure that both hinges at the bottom of the oven door are aligned and fully inserted with the 2 small holes at the bottom of the front panel on the oven.
2. Once the door hinges are inserted, check if the door can be opened and closed fully, and the door is aligned correctly with the control panel. If not, please check if the hinges are inserted fully and in the correct position.
3. Once the door has been reattached correctly then reattach the locking catch on the hinges on both sides.

Removing Glass from Door

1. Push the glass towards the top of the oven door (direction of B), and release from the location bracket (X).
2. Then pull the glass up and away from the oven (in the direction of A).

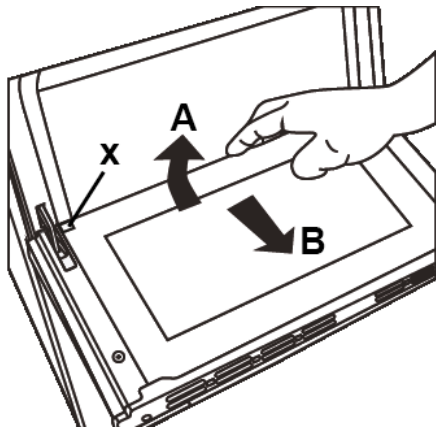

CLEANING & MAINTENANCE

To replace the inner glass:

1. Push the glass towards and under the location bracket (y), in the direction of B.

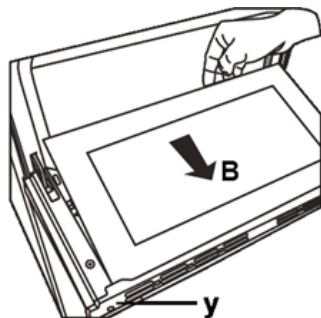

2. Place the glass under the location bracket (X) in the direction of C.

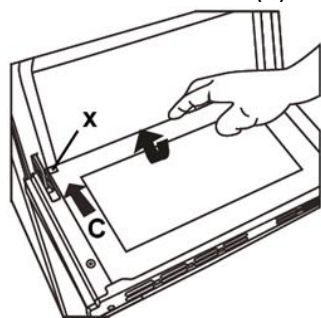

If the oven door is a triple glass oven door, the third glass layer can be removed the same way as the second glass layer.

TROUBLE SHOOTING

Problem	Possible Cause	Solution
The hob or oven cavities can't be switched on	The circuit breaker is defective or turned off	Check circuit breaker is in working order and that it is not switched off
	Power cut or faulty fuse	Check whether other kitchen appliances are working or check in the fuse box to make sure that the fuse for the appliance is working
The hob produces an odour during the first cooking sessions	The appliance is new	Heat a saucepan full of water on each cooking zone for 30 minutes
The oven doesn't heat up	The oven temperature control is incorrectly set	Check the oven temperature dial has been set correctly
Oven light does not work	Electrical supply has disconnected or switched off	Check circuit breaker is in working order and that it is not switched off
	The light is faulty or has been damaged	Replace the light according to the instructions featured earlier in this instruction manual

TROUBLE SHOOTING

Problem	Possible Cause	Solution
Cooking is uneven within the oven or food is being burnt	Location of the shelves are incorrect	Check that the temperature has been set correctly and/or adjust the shelf positions Do not frequently open the door unless you are cooking things that need to be turned. Opening the oven door often means the oven temperature can drop, possibly affecting the result of your cooking
The oven fan is noisy	Oven shelves are vibrating	Check that the oven is level Check that the shelves and cookware being used in the oven are not vibrating or in contact with the oven back panel

GUARANTEE

This product is guaranteed for 12 months from the date of the original purchase. If any defect arises due to faulty materials or workmanship you must contact Customer Services with the original proof of purchase so a replacement or refund can be arranged.

Refund or replacement is at the discretion of Customer Services.

The following conditions apply:

- Customer Services will require a valid proof of purchase at the point of replacement or refund.
- The product must be installed and used in accordance with the instructions contained within this instruction guide and any other instructions for use which have been supplied.
- It must be used for domestic purposes only and for its intended use.
- This guarantee does not cover wear and tear, damage, misuse or consumable parts.

This does not affect your statutory rights.

PRODUCT INFORMATION

Model Number	RH50ETCEH2001B
Rated Voltage	230V ~ 50Hz
External Dimensions(HxWxD)	895m x 495mm x 650mm

Disposal of your old machine

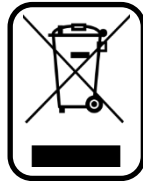

- This symbol on the product or on its packaging indicates that this product should not be treated as household waste. Instead it should be handed over to the applicable collection point for the recycling of electrical and electronic equipment.
- By ensuring this product is disposed of correctly, you will help prevent potential negative consequences for the environment and human health, which could otherwise be caused by inappropriate waste handling of this product.
- For more detailed information about recycling of this product, please contact your local city office, your household waste disposal service or the retailer who you purchased this product from.

Imported by
G2S LIMITED
WIGAN
WN2 4AY

NOTES

A large, empty rectangular box with rounded corners, intended for taking notes.

For Customer Services & Spare
Parts please call **0345 208 8750**
or visit us at
<https://mda.russellhobbs.com>

Revision 1.4



This symbol is known as the 'Crossed-Out Wheeie Bin Symbol'. When this symbol is marked on a product/batteries, it means that the product/batteries should not be disposed of with your general household waste. Only discard electrical/electronic/battery items in separate collection schemes, which cater for the recovery and recycling of materials contained within. Your co-operation is vital to make sure the success of these schemes and for the protection of the environment. For your nearest disposal facility, visit www.recycle-more.co.uk or ask in store for details.

We reserve the right due to possible changes to design, to alter the instruction manual without prior notice.