

This Owner's Manual is provided and hosted by [Appliance Factory Parts](#).



# Russell Hobbs RHE07201DS Owner's Manual

[Shop genuine replacement parts for Russell Hobbs  
RHE07201DS](#)



[Find Your Russell Hobbs Cooker Parts - Select From 29 Models](#)

----- Manual continues below -----



# Russell Hobbs

## Multifunctional Electric Fan Oven Instruction Manual

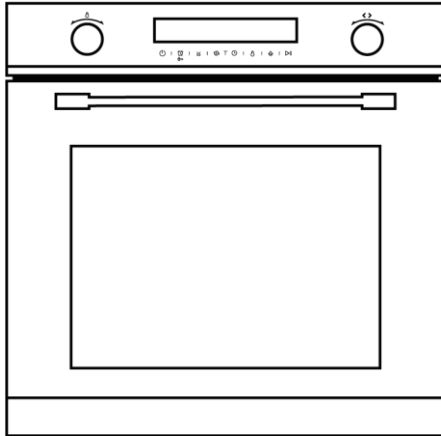

**Model number:  
RHE07201DS**

For Customer Services & Spare Parts please call **0345 208 8750**  
or visit us at [mda.russellhobbs.com](http://mda.russellhobbs.com)

**IMPORTANT:  
RETAIN FOR FUTURE REFERENCE**

# CONTENTS

	<b>Page(s)</b>
Safety instructions	<b>3-5</b>
Product Overview	<b>6</b>
Positioning	<b>7</b>
Installation	<b>8-9</b>
How To Use Your Oven	<b>10-22</b>
Cleaning & Maintenance	<b>23-29</b>
Trouble shooting	<b>30</b>
Guarantee	<b>31</b>
Product Information	<b>32</b>
Notes	<b>33-35</b>
Disposal information	<b>36</b>

# SAFETY INSTRUCTIONS

## **Important Note:**

Please read this booklet before installing and switching on this appliance. The manufacturer assumes no responsibility for incorrect installation and usage as described in this booklet.

**This appliance can be used by children aged from 8 years and above and persons with reduced physical, sensory or mental capabilities or lack of experience and knowledge if they have been given supervision or instruction concerning use of the appliance in a safe way and understand the hazards involved. Children shall not play with the appliance.**

**Electric ovens and hobs must be hard-wired to a suitably rated electrical cooker power point – it is recommended that you consult a qualified electrician. Failure to do so will invalidate your guarantee, liability claims, and could lead to criminal prosecution.**

- Children should be supervised to ensure that they do not play with the appliance.
- If the supply lead is damaged it must be replaced by a qualified person using the correct lead, which is available from our customer helpline on **0345 208 8750**.
- Packaging material is dangerous to children. Never allow children to play with packaging material.
- Check the appliance for damage after unpacking it. Do not connect the appliance if it has been damaged in transport.
- The appliance can only be used safely if it is correctly installed according to the safety instructions. The installer is responsible for ensuring that the appliance works correctly after installation.
- All operations relating to installation and regulation must be carried out by an authorised installation engineer, respecting applicable regulations, standards and the specifications of the local electricity providers.

# SAFETY INSTRUCTIONS

- This appliance can only be installed in a well-ventilated place in accordance with existing regulations and ventilation specifications.
- This appliance is intended for domestic use and the household environment only. The appliance is not intended for use outside.
- Do not tamper with the appliance's interior. If necessary, call our customer helpline.
- Do not switch on the appliance if it is damaged in any way. Contact our customer helpline at the number on the front of the booklet.
- This appliance is only intended for cooking purposes, not as a heating system.
- The manufacturer is not liable for damage which is caused by improper use or incorrect operation.
- Combustible items stored in the cooking compartment may catch fire. Never store combustible items in the cooking compartment. Never open the appliance door if there is smoke inside. Switch off the appliance and unplug it from the mains or switch off the circuit breaker in the fuse box.
- A draught is created when the appliance door is opened. Greaseproof paper may come into contact with the heating element and catch fire. Do not place greaseproof paper loosely over accessories during preheating. Always weigh down greaseproof paper with a dish or a baking tin. Only cover the surface required with greaseproof paper. Greaseproof paper must not protrude over the accessories.
- Always slide accessories into the cooking compartment.
- The appliance and its accessible parts become very hot when in operation. Never touch the interior surfaces of the cooking compartment or the heating elements while hot. Always allow the appliance to cool down first. Keep children at a safe distance.
- Accessories and ovenware become very hot. Always use oven gloves to remove accessories or ovenware from the cooking compartment.
- Shelves and the universal tray must only be placed and used between the 5 side supports.

# SAFETY INSTRUCTIONS

- The universal tray or any other kind of baking tray should not be placed on the bottom of the oven cavity.
- Alcoholic vapours may catch fire in the hot cooking compartment. Never prepare food containing large quantities of drinks with a high alcohol content. Only use small quantities of drinks with a high alcohol content. Open the appliance door with care.
- When you open the appliance door, hot steam may escape. Open the appliance door with care. Keep children at a safe distance.
- Water in a hot cooking compartment may create hot steam. Never pour water into the hot cooking compartment.
- Scratched glass in the appliance door may develop into a crack. Do not use a glass scraper, sharp or abrasive cleaning aids or detergents when cleaning your appliance. Never use strong and abrasive cleaning agents as they will cause surface damage.
- The appliance gets hot. Do not keep combustible objects or aerosol cans in drawers directly underneath the appliance.
- A defective appliance may cause electric shock. Never switch on a defective appliance. Disconnect the appliance from the mains or switch off the circuit breaker in the fuse box. Contact the customer services.
- The cable insulation on electrical appliances may melt when touching hot parts of the appliance. Never bring electrical appliance cables into contact with hot parts of the appliance.
- Penetrating moisture may cause an electric shock. Do not use any high pressure cleaners or steam cleaners.
- When replacing the cooking compartment bulb, the bulb socket contacts are live. Before replacing the bulb, disconnect the appliance from the mains or switch off the circuit breaker in the fuse box.
- Incorrect repairs are dangerous. Repairs may only be carried out by a qualified electrician.
- In the event of a malfunction, turn off the appliance's electricity supply. For repairs, call customer services.
- Carrying the appliance: do not carry or hold the appliance by the door handle. Please use the handles present on the side casing.

# PRODUCT OVERVIEW

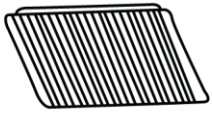
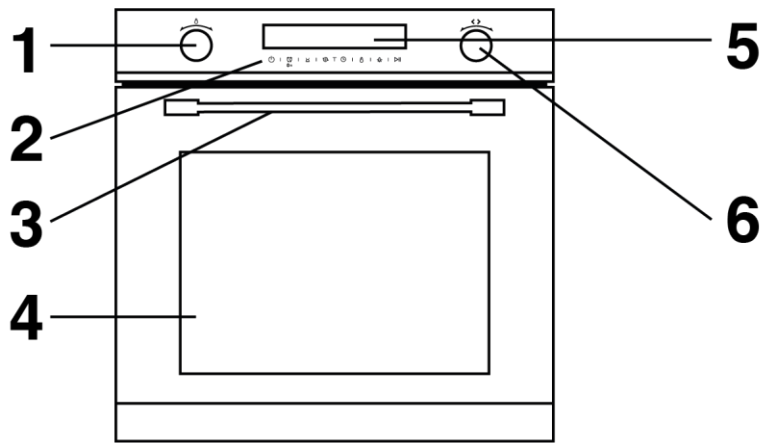

7

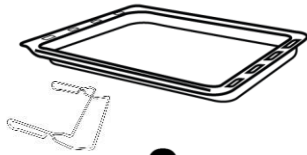

8



9

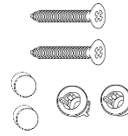

10

- |                           |                                |
|---------------------------|--------------------------------|
| 1. Oven function dial     | 6. Adjustment dial             |
| 2. Function touch control | 7. 2 x Wire shelf              |
| 3. Handle                 | 8. 1 x Universal tray & handle |
| 4. Glass window           | 9. 1 x Wire rack               |
| 5. Display                | 10. 2 x Fixing screws          |

## Unit & Spare Parts

If any of the above parts are missing please contact the customer service team on 0345 208 8750 or visit [mda.russellhobbs.com](http://mda.russellhobbs.com)

# POSITIONING

- This appliance is to be installed under a countertop or in cabinets.
- Avoid damaging the product during installation.
- The appliance can only be used safely if it is correctly installed according to the safety instructions. The installer is responsible for ensuring that the appliance works correctly when installed.
- **Electric ovens and hobs must be hard-wired to a suitably rated electrical cooker power point – it is recommended that you consult a qualified electrician. Failure to do so will invalidate your guarantee, liability claims, and could lead to criminal prosecution.**
- The aperture size must be (H)590 x (W)560 x (D)550mm (please note that the depth size is a minimum measure, and that the oven can be installed in an aperture that has a bigger depth).

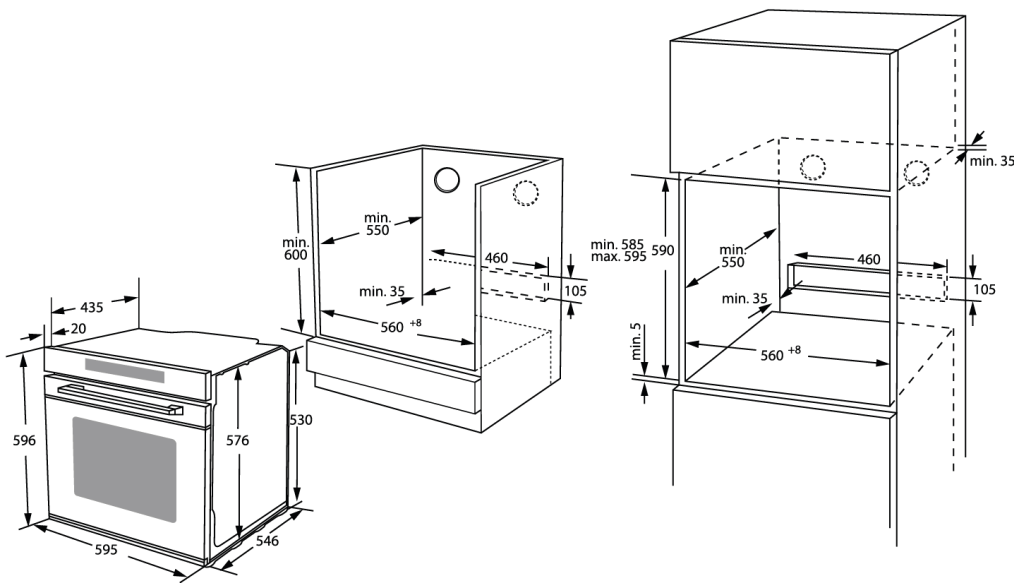

## Note:

- **Select heat-resistant work surface material to avoid larger deformation caused by the heat radiation from the appliance.**
- **This oven has forced air ventilation.**

# INSTALLATION

## Preparation & Installation

Ensure that there are no electric wires, gas or water pipes in the area where holes are to be made.

Components of the appliance may have sharp edges. Wear protective gloves.

1. Ensure that there will be an electrical power point within adequate distance of the oven after it has been installed.
2. Ensure the aperture measures (H)590 x (W)560 x (D)550mm, in accordance with the positioning instructions detailed on the previous page.
3. Carefully and gently put the oven into the aperture recess, making sure that the power cable can still be accessed.
4. Connect the oven to the electrical power point before pushing the oven into the aperture fully.
5. Once this is done, open the oven door and secure the oven to the kitchen cabinet with 2 distance holding screws, which fit the holes in the oven frame on either side (near the top):

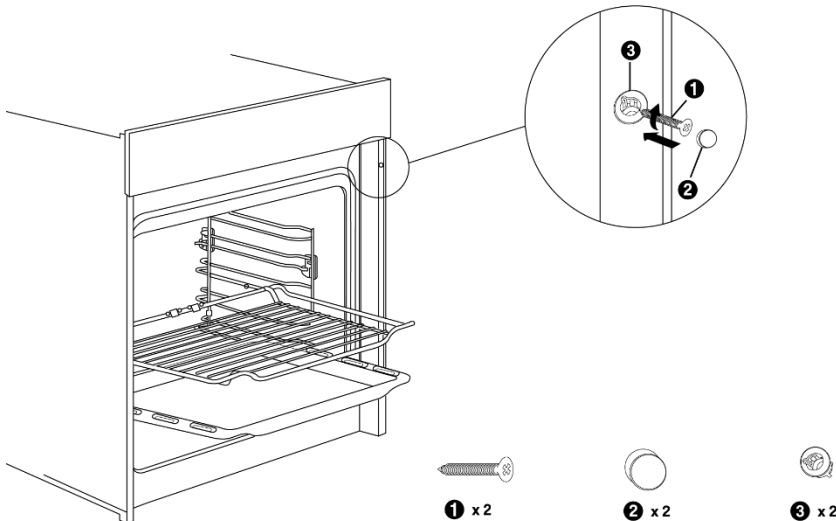

# INSTALLATION

## Electrical Connection









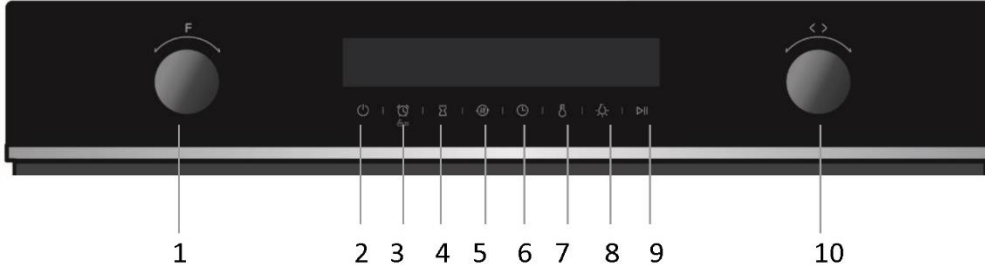

- **WARNING - THIS APPLIANCE MUST BE EARTHED**
- This appliance is designed to be connected to a 220-240V~50Hz AC electricity supply.
- Before proceeding with the electrical connection, verify that the current carrying capacity of the system and the isolator / main switch is adequate for the maximum power rating of the oven.
- Electrical installation of the residence and of the appliance's isolator must be earthed and conform with the required safety regulations.
- If there is no suitable circuit and a fused switch, they must be installed by a qualified electrician before the appliance is connected.
- An isolator switch must be easily accessible once the oven has been installed.
- Do not use adaptors, multiple sockets and/or extension leads.
- A circuit breaker with a contact opening of at least 3 mm, rated 32A and delayed functioning type must be installed inside the supply circuit.
- During installation, please ensure that insulated cables are used. An incorrect connection might damage your appliance and will void the manufacturer's guarantee.
- All repairs must be carried out by an authorised service personnel or a qualified electrician.
- Switch off/isolate your appliance before each maintenance.
- The GREEN/YELLOW wire is the EARTH and must be connected to the terminal which is marked with the letter E or by the earth symbol or coloured GREEN or GREEN/YELLOW.
- The BLUE wire is the NEUTRAL and must be connected to the terminal marked with the letter N or coloured BLACK.
- The BROWN wire is the LIVE wire and must be connected to the terminal marked with the letter L or coloured RED.

# HOW TO USE YOUR OVEN

## Control Panel

The appliance has an oven function dial, adjustment dial, a display, and function buttons. See explanations below:



1	 Oven function dial	Turn to change the oven function
2	 On / Off	Powers the oven on and off
3	 Timer / Child lock	Timer function / Child lock (touch & hold for 3 secs)
4	 Cooking end time	Set cooking end time
5	 Quick pre-heat	Quick pre-heat function
6	 Cooking duration & clock setting	Cooking duration time & clock setting (standby mode)
7	 Temperature setting	Temperature setting function
8	 Light on / off	Turns light on and off
9	 Start / Pause	Starts and pauses the cooking program
10	 Adjustment dial	Turn to adjust

# HOW TO USE YOUR OVEN



## Display

This will show the time, function icons, and other information.



## Oven Function Dial

The oven function dial allows you to set the oven function mode for the oven. The dial can be turned clockwise or anti-clockwise to set the required oven function.

When the required type of function is selected, touch the  symbol, the lights inside the oven will light up. The temperature can be set before or after the  symbol is touched.

The oven will start to heat up and the lines on the display will increase as the temperature inside the oven increases. All lines will be shown when the temperature inside has reached the temperature that has been selected.

**Note: Always pre-heat the oven to the required temperature before cooking.**

## Adjustment Dial

Use the adjustment dial to set the required temperature and time for the oven. The dial can be rotated clockwise and anti-clockwise to set the required temperature/time.

The temperature can be set between 30°C and 250°C. The temperature range will differ by function.

# HOW TO USE YOUR OVEN

## The Oven Cavity

- The oven light is located in the cooking compartment. During oven operation, the oven light is on (unless turned off manually using the light on/off button), except for the ECO oven function. The light will go off 5 seconds after the ECO function has been started.
- The light turns on automatically when an oven function has been selected and the  symbol is touched. The oven light can also be switched on without the oven heating up, by manually touching the light on/off symbol.
- A cooling fan protects the oven from overheating. The cooling fan switches on and off as required. The hot air escapes above the door.
- So that the cooking compartment cools down quickly after operation, the cooling fan continues to run for a certain period afterwards.
- There are side rack supports either side of the compartment that accessories such as the wire shelf, baking tray, etc. can be inserted in to.
- The coating of the oven cavity is enamel.
- Before you use the oven and the accessories for the first time, clean them with hot soapy water and a soft dish cloth.
- Clean all accessories by hand, do not clean in the dishwasher.

### WARNING:

- **When it is first used, it is normal for the oven to give off odours; this does not pose any risk and does not indicate a malfunction. They will disappear in time.**

# HOW TO USE YOUR OVEN



## Setting the Clock

When the oven is first connected to the electrical supply and powered on, the clock will need to be set. The display will automatically show the time as “00:00” and there will be a single beep.

**Note:** Ensure the correct time is set before using the oven.

**Note:** The clock is a 24-hour clock, for example 2.20PM will be shown as 14:20.





To set the correct time:

1. Touch the  symbol and then turn the '</>' adjustment dial to set the hour.
2. Touch the  symbol to confirm the hour setting.
3. Turn the '</>' adjustment dial to set the minutes.
4. Touch the  symbol to confirm the minute setting and the clock will go into standby mode.







# HOW TO USE YOUR OVEN

## Types of Heating Modes

This oven has a number of modes. Below is an overview to enable you to find the suitable heat settings required for certain dishes/cooking.

Symbol	Temperature Range	Function
	30°C - 250°C	<p><b>Top &amp; Bottom Heating:</b> Heat is emitted evenly from the top and bottom elements, which work together to provide convectional cooking.</p> <p>This function is best suited for single items that are centred in the oven i.e. cakes and pizzas on baking trays, lean joints of beef, etc.</p>
	50°C - 250°C	<p><b>Convection Heating:</b> A fan with a ring heating element on the back of the oven ensures that the heated air is distributed evenly.</p> <p>You can bake cakes, pizza's, biscuits, small cakes and puff pastry on two shelves at the same time.</p>
	140°C - 240°C	<p><b>Eco:</b> An energy-saving cooking mode where the fan distributes the heated air that is emitted from the bottom and rear heating elements around the food. <b>Note: The oven light will only operate for the first 5 seconds when this function is selected.</b></p> <p>This function is best suited for small amounts of food that are best cooked gently i.e. bakes, meat dishes, vegetables, frozen pizza, and biscuits. This function is not suitable for cakes and large amount of food.</p>
	50°C - 250°C	<p><b>Convection Heating with Fan:</b> The fan distributes the heated air that is emitted by the top and bottom heating elements around the food.</p> <p>This function is best suited for baking, roasting all meat, vegetables, and pre-cooked meals.</p>
	150°C - 250°C	<p><b>Single Grill:</b> Part of the area below the grill heating element becomes hot. The inner grill element is on.</p> <p>This function can be used to grill a small number of burgers, sausages, fish or bread.</p>

# HOW TO USE YOUR OVEN





Symbol	Temperature Range	Function
	50°C - 250°C	<p><b>Double Grill with Fan:</b> The fan distributes the heated air around the food. The grill element and fan switch on and off alternately.</p> <p>Hot air grilling is particularly suitable for grilling fish, poultry and larger pieces of meat.</p>
	150°C - 250°C	<p><b>Double Grill:</b> The whole area below the grill heating element becomes hot. The inner and outer grill elements are on.</p> <p>This function can be used to grill a large number of burgers, sausages, fish or bread.</p>
	50°C - 250°C	<p><b>Convection with Bottom Heating (Pizza Function):</b> The fan distributes the heated air that is emitted from the bottom and rear heating elements around the food.</p> <p>Best suited for pizzas and other foods/dishes that need a lot of heat from underneath.</p>
	30°C - 220°C	<p><b>Bottom Heating:</b> The temperature is emitted from below which provides heat to the base of food.</p> <p>Use bottom heating for baking and browning dishes from below. It is also ideal for slow cooking dishes such as casseroles, stews, and pastries and pizzas where a crispy base is desired.</p>
	-	<p><b>Defrost:</b> Circulates air in the oven at room temperature (without the use of any heat) enabling quicker thawing of frozen food.</p> <p>Use this to defrost food only.</p>
	30°C - 45°C	<p><b>Dough Proving:</b> Low temperature heat is produced to help prove and culture yeast when making yeast dough and sourdough.</p>

# HOW TO USE YOUR OVEN

## Note:

- If the oven door is opened in the middle of a cooking program, the program will not be paused. Please be careful with the high temperature.
- Do not cover the ventilation slots to avoid the oven to overheating.
- When the oven is switched off, the cooling fan may continue to run for a while to help the oven cool down quickly.

## Start Cooking with the Oven



1. When the oven is powered on, turn the oven function dial to select the programme you need. Turn the '</>' adjustment dial to set the temperature.
2. Touch the  symbol to start the cooking. If the  symbol is not touched, the oven will go back to stand by mode after 5 minutes. During the cooking process, simply touch  to cancel the programme if needed.
3. After the temperature is set, touch the  symbol to select the cooking duration required, and adjust it by turning the '</>' adjustment dial.

## Making Changes During Cooking





- It is possible to change the heating mode, time and temperature during cooking. Simply turn the oven function dial to change the programme, or turn the '</>' adjustment dial to change the temperature. After the changes have been made, the oven will cook at the changed function, temperature and/or time. However in order to have the best cooking results, we recommend to choose the right setting at the beginning, prior to cooking.
- During the cooking process, you can touch the  symbol to cancel it.

# HOW TO USE YOUR OVEN



## Quick Pre-Heat

1. This oven comes with a quick preheat function to enable the preheat time to be shortened. This function can only be used when an oven function and temperature have been selected first.
2. Turn the function dial to select an oven function, then turn the '</>' adjustment dial to select the required temperature. Then touch the  symbol. Note, the quick preheat function cannot be enabled if the  symbol is touched after selecting the oven function and temperature.
3. The  quick pre-heat icon will be shown on the display. There will be a beep and the icon will disappear when the oven has reached the required temperature.
4. The quick pre-heat function is not available for all functions, i.e. defrost.

## Timer

- Touch the  symbol, and then turn the '</>' adjustment dial to select the hour, touch the  symbol again to confirm and turn the '</>' adjustment dial again to select the minutes, and touch the  symbol to confirm.
- The timer can only be set before or during the cooking.
- Once the set time is up, the oven will beep 10 times.
- To cancel touch the  symbol.







## Child Lock

- The child lock function is to stop children from altering cooking times or turning on the oven. No buttons will function in this mode.
- The child lock can be set whether the oven is operating or not.
- To set the lock, touch the  symbol for 3 seconds. There will then be a padlock symbol shown on the display as the lock activates.
- The lock is now functional.
- To cancel the lock, touch the  symbol for 3 seconds. The lock symbol will disappear signalling that the lock is cancelled.

# HOW TO USE YOUR OVEN

## Cooking Duration Time









This function is used when you want to cook for a desired time range. The maximum cooking period is 9 hours. The food that is to be cooked needs to be put into the oven.

1. Turn the function dial to select a programme.
2. Turn the adjustment dial to select the temperature.
3. Touch the  symbol and the time '00:00hr' will flash on the display 7 times. You will need to set the time while the time is flashing. If you don't, then you will need to touch the  symbol again.
4. Turn the '</>' adjustment dial clock-wise to select the cooking duration that you require, the time will flash on the display and will then stay.
5. Touch the  symbol to start the program. The time will be shown and will count down. If you want to set a cooking end time then do not touch the  symbol and do not follow the remaining steps on this page. To set the cooking end time you will need to touch the  symbol and follow the steps on the next page (do not follow the remaining steps on this page).
6. The oven will beep and 'End' will be shown on the display when the cooking duration time has been reached.
7. To amend the cooking duration time, touch  the symbol and the time on the display will flash. Turn the '</>' adjustment dial and select the new cooking duration time you require. Don't touch any button and the new time will be set when the time on the display has stopped flashing
8. To cancel the cooking duration function touch the  symbol.

# HOW TO USE YOUR OVEN

## Cooking End Time

This function is used to cook according to a desired finishing time. The food that is to be cooked needs to be put into the oven.

1. Set the cooking duration time by following the instructions laid out on the previous page. However, touch the  symbol instead of the  symbol in step 5.
2. When the  symbol is touched, the time will show on the display and the hour time will flash.
3. Turn the '</>' adjustment dial clock-wise to select the hour time you require the cooking programme to end. Touch the  symbol to confirm and the minute time will flash.
5. Turn the '</>' adjustment dial clock-wise to select the minute time you require the cooking programme to end. Touch the  symbol. The cooking end time has now been set.
6. Touch the  symbol to start the program. The  symbol will flash on the display.
7. The oven will beep 5 times when the cooking end time has been reached.
8. To cancel the cooking duration function touch the  symbol.

## Oven Lights

- The oven light can be manually turned on and off by touching the  symbol. The oven light can be turned on and off when the oven is in use or in standby mode.

# HOW TO USE YOUR OVEN

## **Energy Saving**

The following advice is to help you save energy:

- Only preheat the oven if this is specified in the recipe.
- Open the oven door as infrequently as possible.
- Use black enamelled baking trays, tins etc., as they absorb the heat well.
- If you need to cook, bake, or roast a number of different foods then it is best to do this one after the other. The oven will be at temperature, reducing the need to pre-heat the oven again.
- Cook more than 1 item at a time using the different accessories provided.

# HOW TO USE YOUR OVEN

## Accessories

### WARNING:

- Correct placement of the shelves between the side supports is imperative. This will ensure that food does not fall off or slide out when in the oven or being carefully removed from the oven.
- Ensure that you always insert the accessories into the cooking compartment the right way round.
- Shelves and the universal tray must only be placed and used between the 5 side supports.
- The universal tray or any other kind of baking tray should not be placed on the bottom of the oven cavity.

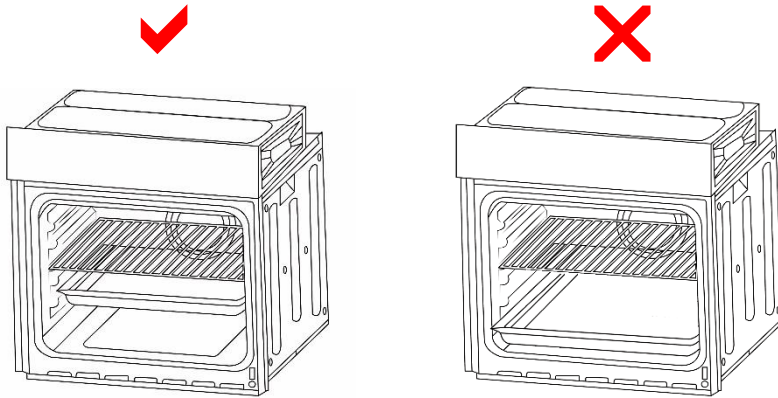

The accessories can be inserted in the oven at 5 different levels. Always insert the accessories as far as they can go to ensure that they do not touch the door glass.

**Wire Shelf** – Use for ovenware, cake tins, roasts, grilling, and frozen meals. Slide the wire rack into the oven with the raised part at the back and at the top.

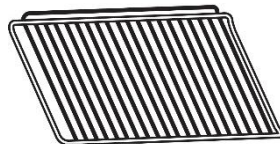

# HOW TO USE YOUR OVEN

**Universal Tray** – Use for cooking large quantities of food such as cakes, pastries, frozen food, etc. Can also be used under the wire rack to catch fat when grilling. Slide the baking tray into the oven with the sloping edge facing towards the oven door.

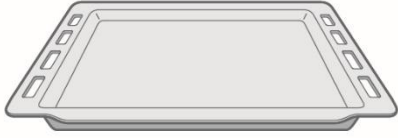

**Wire Rack** – Use for grilling and roasting. Place the wire insert into the universal tray with the legs facing downwards. This ensures that dripping fat and meat juices are collected.

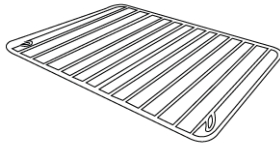

**Note:**

The cavity has five shelf positions. Ensure that the tray and rack are always inserted properly, orientated correctly, and are not touching the oven door.

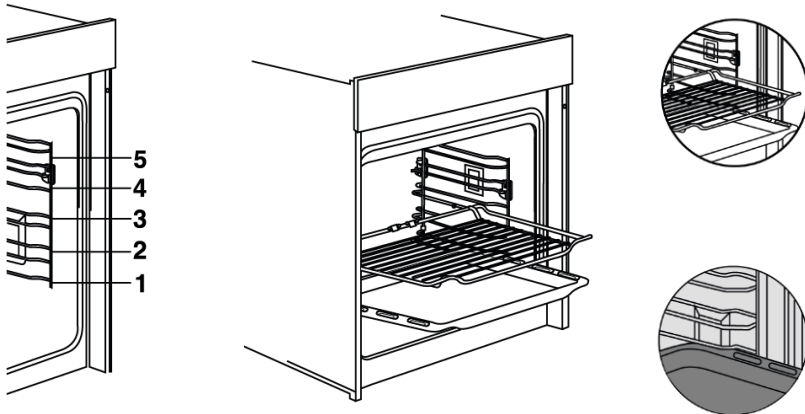

# CLEANING & MAINTENANCE

## Important Notes:

- The appliance will become hot during operation, so allow the appliance to cool down before cleaning.
- Do not use any high-pressure cleaners or steam cleaners.
- Wash new sponge cloths thoroughly before use.
- Do not leave acidic substances (e.g. lemon juice, vinegar), on stainless steel parts.
- Follow all instructions and warnings included with the cleaning agents.

## How to Clean

Observe the information in the table below to ensure that the different surfaces are not damaged by using the wrong type of cleaning agent. Clean all accessories by hand, do not clean in the dishwasher.

### Do not use:

- Harsh or abrasive cleaning agents.
- Cleaning agents with a high concentration of alcohol.
- Hard scouring pads or sponges.
- High-pressure cleaners or steam cleaners.

Surface Type	How to Clean
Stainless Steel	Use hot soapy water and clean with a dish cloth and dry with a soft cloth. Clean stainless steel surfaces in the direction of the grain only. Special stainless steel cleaning products are available from specialist retailers. Apply a very thin layer of the cleaning product with a soft cloth.
Painted Surfaces	Use hot soapy water and clean using a damp dish cloth and dry with a soft cloth/towel. Do not use any stainless steel cleaners.
Aluminium and Plastic	Use glass cleaner and clean with a soft cloth.
Glass	Use glass cleaner and clean with a soft cloth. Do not use a glass scraper.
Enamel	Clean with some washing-up liquid and a damp cloth. Dry with a soft cloth.

# CLEANING & MAINTENANCE

## How to Clean:

- After each use, clean all surfaces once they have cooled down. If any residue is left (baked-on food, drops of grease etc.), however little, it will become stuck to the surface and more difficult to remove later.
- Always clean off any liquid as soon as it is spilt. You will save yourself any unnecessary effort.
- Where possible, do not allow salt to come into contact with the surfaces of the appliance.

## Causes of Damage:

- **Accessories, foil, greaseproof paper or ovenware on the cooking compartment floor:** Do not place accessories on the cooking compartment floor. Do not cover the cooking compartment floor with any sort of foil or greaseproof paper. Do not place ovenware on the cooking compartment floor if a temperature of over 50°C has been set. This will cause heat to accumulate. The baking and roasting times will no longer be correct and the enamel will be damaged.
- **Water in a hot cooking compartment:** Do not pour water into the cooking compartment when it is hot. This will cause steam. The temperature change can cause damage to the enamel.
- **Moist food:** Do not store moist food in the cooking compartment when it is closed for prolonged periods. This will damage the enamel.
- **Fruit juice:** When baking particularly juicy fruit pies, do not pack the baking tray too generously. Fruit juice dripping from the baking tray leaves stains that cannot be removed. If possible, use the deeper universal pan.
- **Cooling with the appliance door open:** Only allow the cooking compartment to cool when it is closed. Even if the appliance door is only open a little, front panels of adjacent units could be damaged over time.

# CLEANING & MAINTENANCE

- **Very dirty door seal:** If the door seal is very dirty, the appliance door will no longer close properly when the appliance is in use. The fronts of adjacent units could be damaged. Always keep the door seal clean.
- **Never use the appliance door as a seat, shelf, or worktop:** Do not sit on the appliance door, or place or hang anything on it. Do not place any cookware or accessories on the appliance door.
- **Inserting accessories:** Accessories can scratch the door panel when closing the appliance door. Always insert the accessories into the cooking compartment as far as they will go.

## Changing the Bulb

If the bulb(s) in the oven light(s) fail, it must be replaced with a heat resistant 25 watt bulb only. To replace the bulb follow the below steps:

**Note:** 1 oven lamp is located at the top left corner of the oven. The other is located on the right side of the cavity wall.

1. Switch off the circuit breaker of the unit's mains outlet or fuse box.
2. Place a tea towel in the oven when it is cold to prevent damage.
3. For the corner light unscrew the glass cover by turning it anti-clockwise.
4. For the side light unclip the glass cover.
5. Replace the bulb with one of the same type.
6. Screw the glass cover back in.
7. Remove the tea towel and switch on the circuit breaker.

Corner light

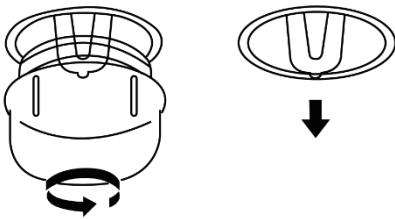

Side light

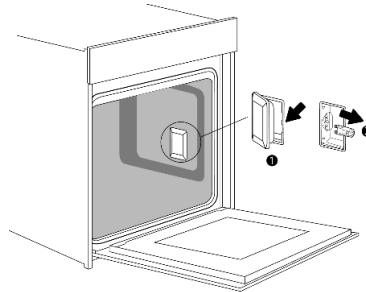

# CLEANING & MAINTENANCE

## Removing the Door

Please remove the door by following the below steps:

1. Open the door fully, you will see the door hinges on either side of the door. The hinges have locking levers which will be in the closed position.
2. While carefully supporting the door, lift up and away the locking levers on both sides.
3. Still supporting the door, fully close the door gently. Then holding the door on both sides, pull it out and upwards to detach the door from the oven.

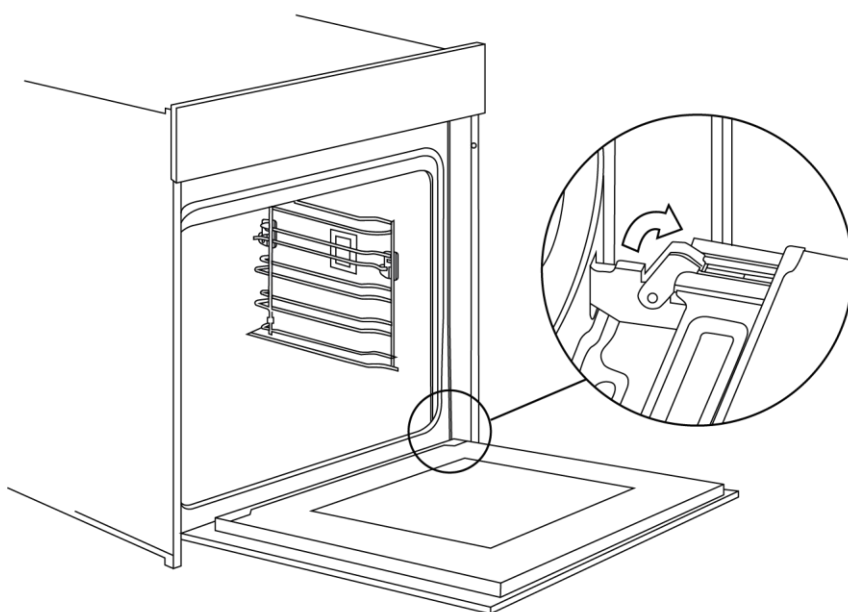

# CLEANING & MAINTENANCE

## Door Assembly

To reattach the door, please follow the below steps:

1. When installing the door, you must make sure that both hinges at the bottom of the oven door are aligned and fully inserted with the 2 small holes at the bottom of the front panel on the oven.
2. Once the door hinges are inserted, check if the door can be opened and closed fully, and the door is aligned correctly with the control panel. If not, please check if the hinges are inserted fully and in the correct position.
3. Once the door has been reattached correctly then reattach the lock on the hinges on both sides

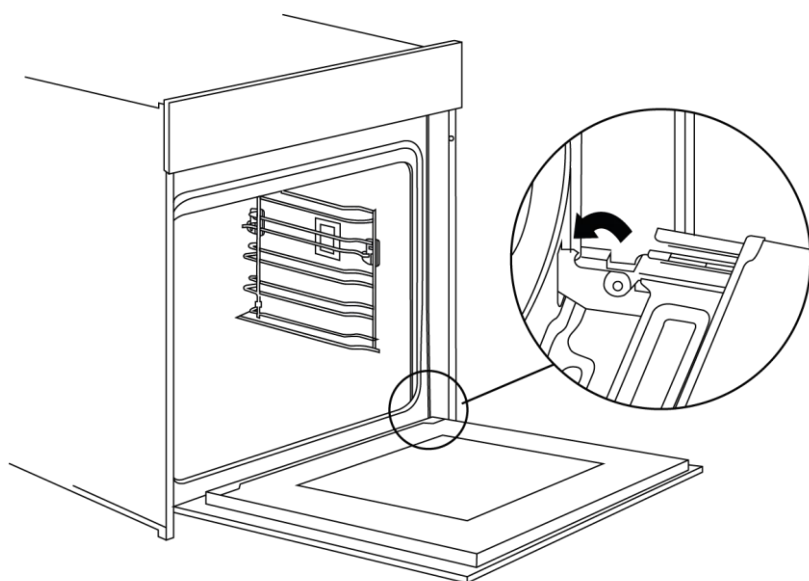

# CLEANING & MAINTENANCE

## Dismantling the Door

The door can be disassembled for cleaning. Please follow the below steps:

1. Hold the door and press in the release buttons on both sides. Pull the top cover out.
2. Once the top cover is removed, the glass panels can be removed and cleaned. Care needs to be taken when removing and handling the pieces of glass as they could break.
3. Clean the glass/door in accordance with the cleaning instructions and guidelines provided in this instruction manual and the cleaning products suggested.
4. When the glass panels have been cleaned and are dry, they must be replaced in the same locations/order as they were removed.
5. When the glass panels are in place, put the top cover back on the top of glass/door ensuring the guides at the side are aligned correctly and push down to click in position.

### Note:

- When the top cover on the door is removed, the glass panel on the door will be loose. Please handle with caution to avoid any damages or injury.
- After removing the top cover of the door, the hinges will become loose. Keep your hands away the hinges to avoid any injuries.

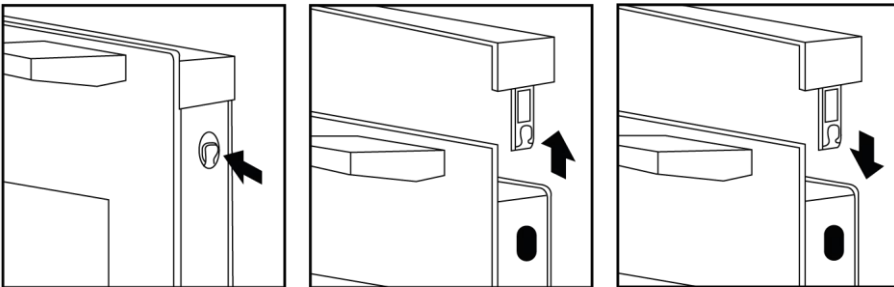

# CLEANING & MAINTENANCE

## Removing the Side Racks

The side racks in the oven cavity can be removed for deep cleaning. Follow the below steps (ensure the oven & side racks are cold and not hot):

1. Carefully hold the side rack at its front (near where it is inserted into the oven cavity) and pull it away from the cavity.
2. The rack will still be attached to the oven cavity at the back and to remove it fully from the oven cavity simply pull it out and away from where it is inserted in to the cavity.
3. Clean the rack(s) and allow to fully dry before reinserting them by reversing steps 1 & 2.

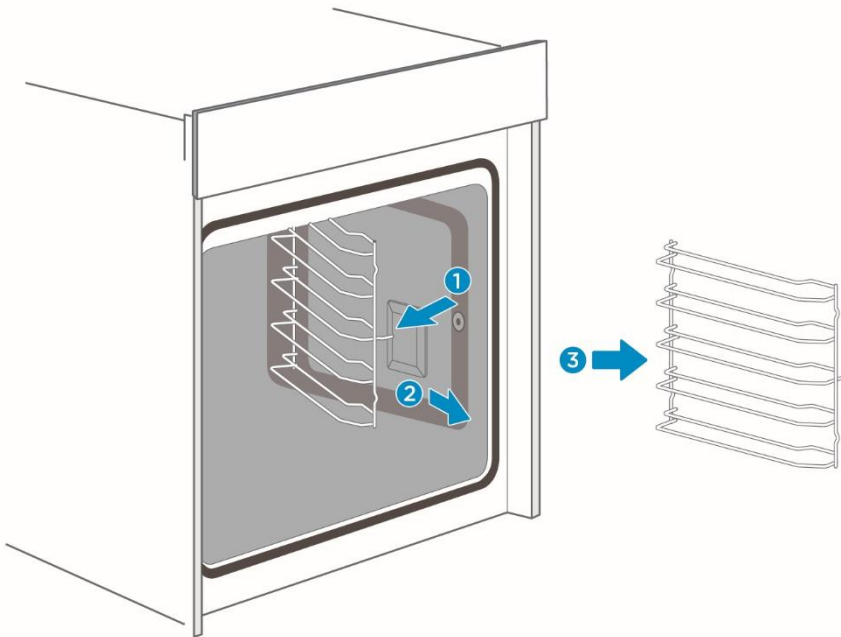

# TROUBLE SHOOTING

Problem	Possible Cause	Solution
No power	The circuit break is defective or turned off	Check circuit breaker is in working order and that it is not switched off
	Power cut or faulty fuse	Check whether other kitchen appliances are working or check in the fuse box to make sure that the fuse for the appliance is working
Functions are none responsive when turning the dials	There may be dust between the connections or the child lock is on	Turn the control dials several times to attempt to remove the dust.  Remove the child lock function by touching and holding the clock icon for 3 secs
The oven doesn't heat up	One or both dials has not been set, or the start button has not been touched	Check the oven function and temperature dials have both been set, and that you have started the programme
The clock flashes	There has been a power cut	Reset the clock
Food is being burnt	Location of the shelves are incorrect or the cooking function that has been selected is incorrect	Adjust the shelf locations and/or the cooking function that is being used

# GUARANTEE

This product is guaranteed for 12 months from the date of the original purchase. If any defect arises due to faulty materials or workmanship you must contact Customer Services with the original proof of purchase so a replacement or refund can be arranged.

Refund or replacement is at the discretion of Customer Services.

**The following conditions apply:**

- Customer Services will require a valid proof of purchase at the point of replacement or refund.
- The product must be installed and used in accordance with the instructions contained within this instruction guide and any other instructions for use which have been supplied.
- It must be used for domestic purposes only and for its intended use.
- This guarantee does not cover wear and tear, damage, misuse or consumable parts.

**This does not affect your statutory rights.**

# PRODUCT INFORMATION

<b>Model Number</b>	<b>RHEO7201DS</b>
<b>Rated Voltage</b>	<b>220V – 240V ~ 50Hz - 60Hz</b>
<b>External Dimensions (HxWxD)</b>	<b>596mm x 595mm x 546mm</b>

# Notes

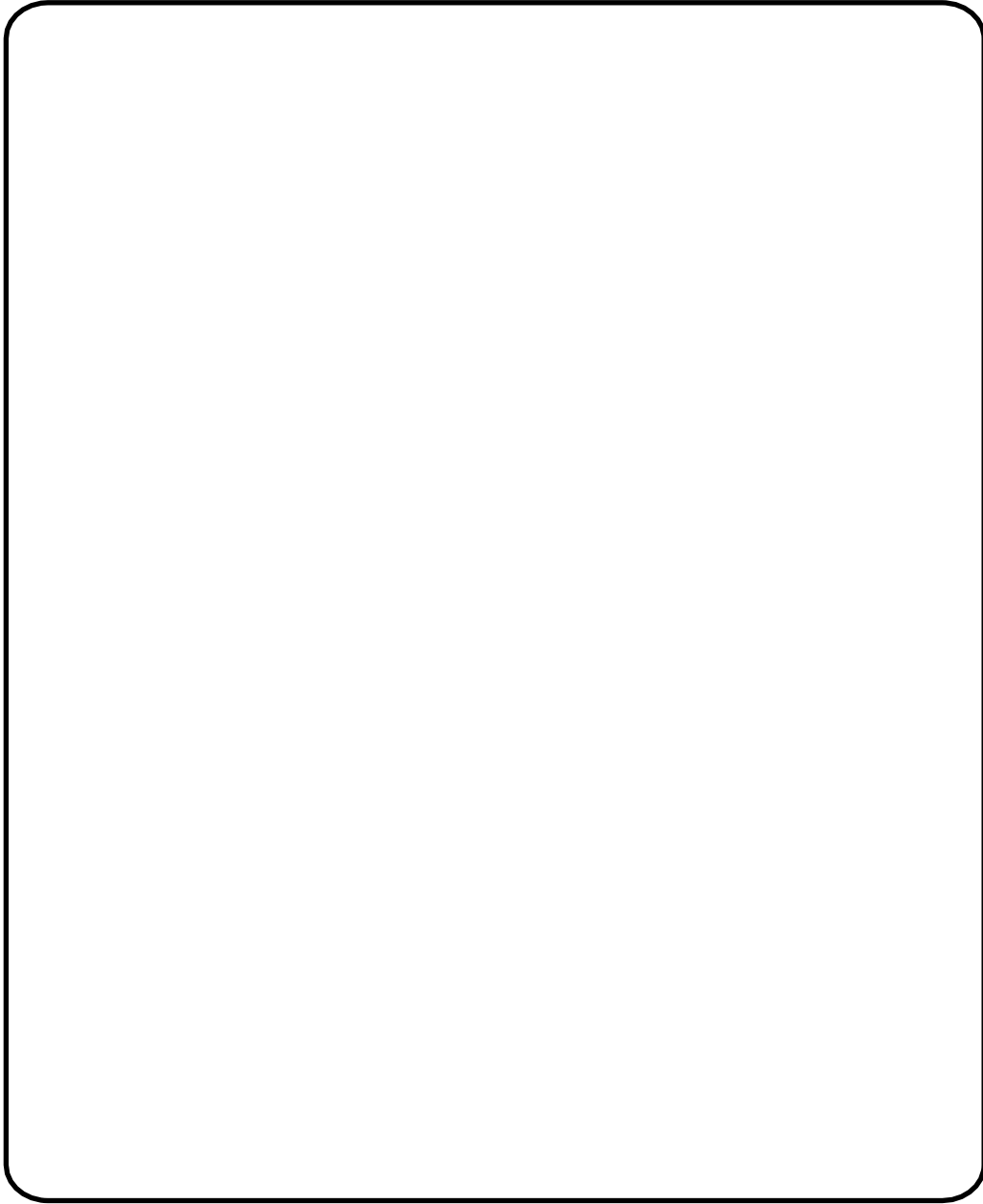

# Notes

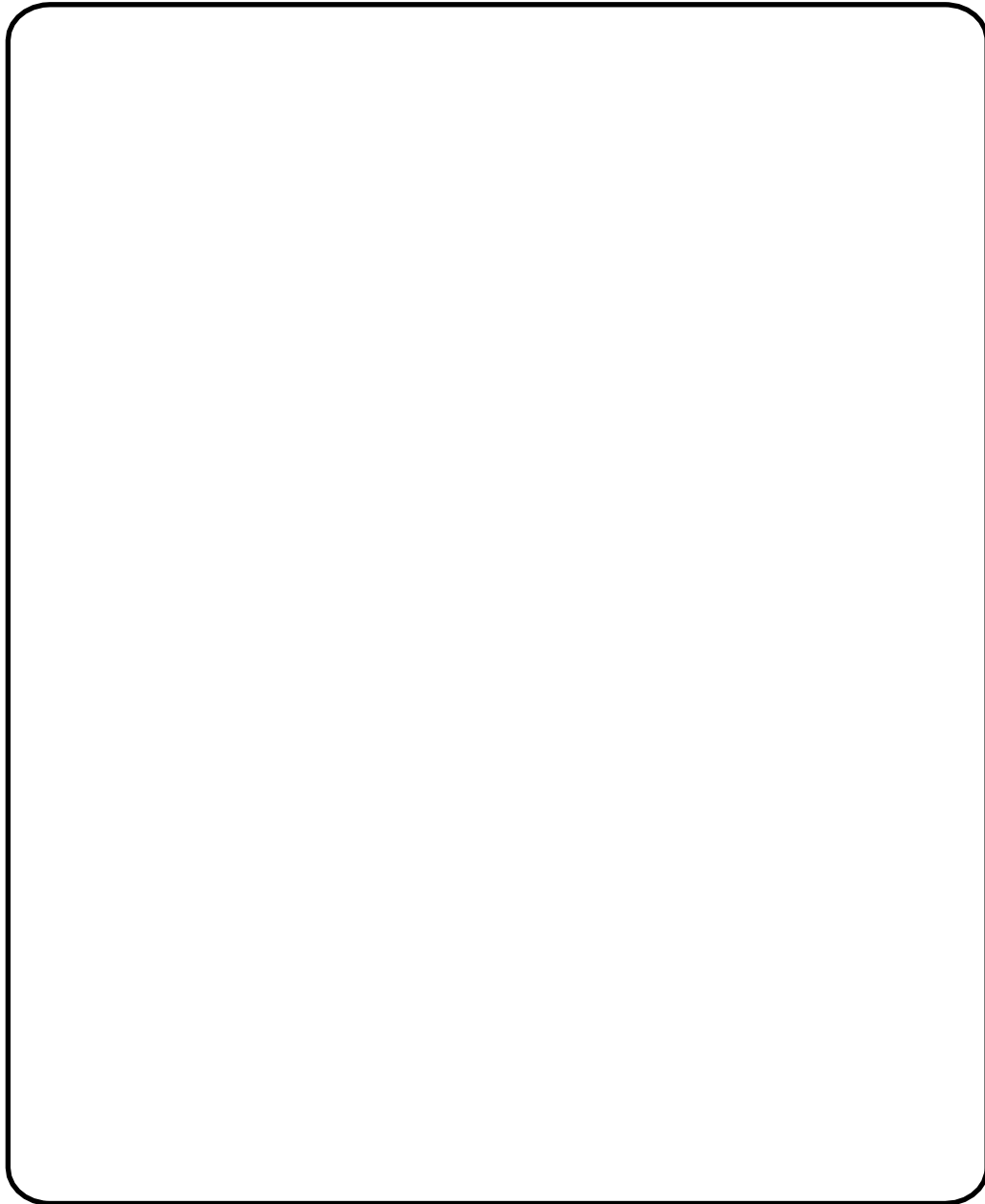

# Notes

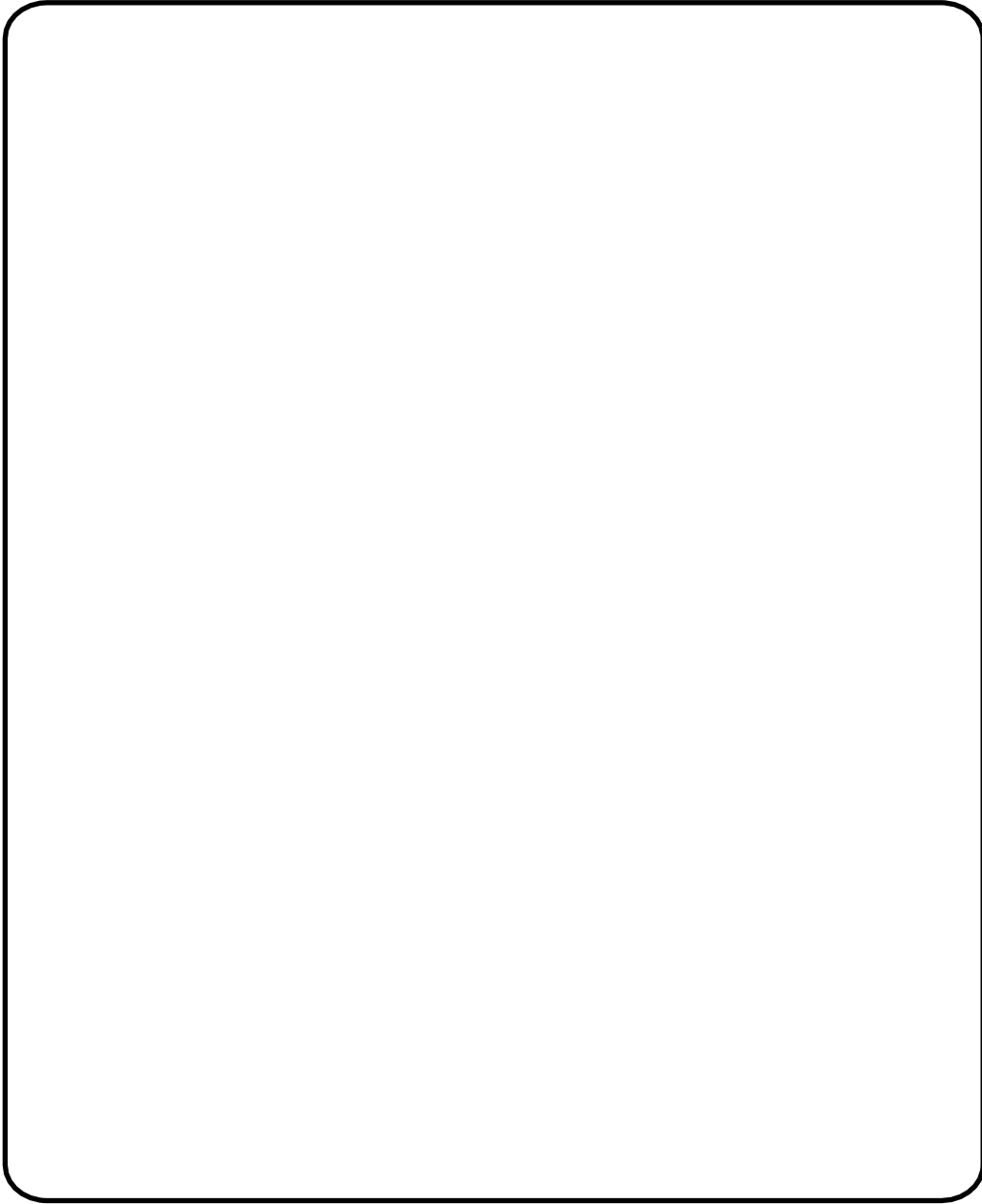



# Russell Hobbs

Russell Hobbs is a registered trademark used under license from Spectrum Brands (UK) Ltd. Made under license by G2S Limited, Wigan, WN2 4AY/G2S (NI) Ltd, Belfast, BT5 5AD.

Russell Hobbs Support: call **0345 208 8750** or visit: [mda.russellhobbs.com](http://mda.russellhobbs.com)

**UK  
CA**

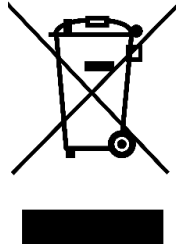

The 'wheelee bin' symbol is known as the 'Crossed-out wheelee bin Symbol'. When this symbol is marked on a product/batteries, it means that the product/batteries should not be disposed of with your general household waste. Only discard electrical/electronic/battery items in separate collection schemes, which cater for the recovery and recycling of materials contained within. Your co-operation is vital to ensure the success of these schemes and for the protection of the environment. For your nearest disposal facility, visit [www.recycle-more.co.uk](http://www.recycle-more.co.uk) or ask in store for details.

SEDEX – Connecting businesses and their global suppliers to share ethical data and enabling improvement in ethical performance. Visit [www.sedex.org.uk](http://www.sedex.org.uk) for further information.

We reserve the right, due to possible changes to design, to alter the instruction manual without prior notice.

Revision 3