

This Owner's Manual is provided and hosted by [Appliance Factory Parts](#).



Russell Hobbs RH77IH501B Owner's Manual

[Shop genuine replacement parts for Russell Hobbs
RH77IH501B](#)



[Find Your Russell Hobbs Cooker Parts - Select From 29 Models](#)

----- Manual continues below -----



Russell Hobbs

Electric Induction Hob Instruction Manual

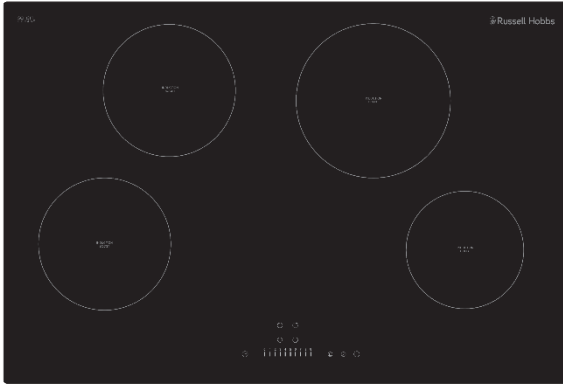

Model number(s):
RH77IH501B

For Customer Services & Spare Parts please call **0345 208 8750**
or visit us at mda.russellhobbs.com

IMPORTANT:
RETAIN FOR FUTURE REFERENCE

Contents

Safety Instructions	3-5
Product Overview	6
Positioning	7-8
Installation	9-10
Induction Introduction	11
Pans & Energy Saving	12-13
Usage	14-31
Cleaning & Maintenance	32-34
Trouble shooting	35
Fault codes	36
Guarantee	37
Technical specification	38
Notes	39

Safety Instructions

Important note:

Please read this booklet before installing and switching on this appliance. The manufacturer assumes no responsibility for incorrect installation and usage as described in this booklet.

This appliance can be used by children aged from 8 years and above and persons with reduced physical, sensory or mental capabilities or lack of experience and knowledge if they have been given supervision or instruction concerning use of the appliance in a safe way and understand the hazards involved. Children shall not play with the appliance.

Electric ovens and hobs must be hard-wired to a suitably rated electrical cooker power point – it is recommended that you consult a qualified electrician. Failure to do so will invalidate your guarantee, liability claims and could lead to criminal prosecution

- Children should be supervised to ensure that they do not play with the appliance.
- If the supply lead is damaged it must be replaced by a qualified person using the correct lead, available from **0345 208 8750**.
- Packaging material is dangerous to children. Never allow children to play with packaging material.
- Check the appliance for damage after unpacking it. Do not connect the appliance if it has been damaged in transport.
- The appliance can only be used safely if it is correctly installed according to the safety instructions. The installer is responsible for ensuring that the appliance works correctly after installation.
- All operations relating to installation and regulation must be carried out by an authorised installation engineer, respecting applicable regulations, standards and the specifications of the local electricity providers.

Safety Instructions

- This appliance can only be installed in a well-ventilated place.
- This appliance is intended for domestic use and the household environment only. The appliance is not intended for use outside.
- Do not tamper with the appliance's interior. If necessary, call our customer helpline.
- Do not switch on the appliance if it is damaged in any way. Contact our customer helpline.
- This appliance is only intended for cooking purposes, not as a heating system.
- Do not leave the appliance unattended during operation. The manufacturer is not liable for damage which is caused by improper use or incorrect operation.
- Hot oil and fat can ignite very quickly. Never leave hot fat or oil unattended. Never use water to put out burning oil or fat, switch off the appliance. Extinguish flames carefully using a lid, fire blanket or something similar.
- Operating several cooking zones at the same time gives rise to a great deal of heat.
- The accessible parts become very hot when in operation. Never touch hot parts. Keep children at a safe distance.
- Do not use covers. These can cause accidents, due to overheating, catching fire or materials shattering, for example.
- Do not use inappropriate child safety shields or hob guards. These can cause accidents.
- The hob will become very hot. Never place combustible items on the hob. Never place objects other than cookware on the hob.
- The appliance gets hot. Do not keep combustible objects or aerosol cans in drawers directly underneath the hob.
- A defective appliance may cause electric shock. Never switch on a defective appliance. Switch off the circuit breaker in the fuse box and contact customer services.

Safety Instructions

- Cracks or fractures in the glass ceramic may cause electric shocks. Switch off the circuit breaker in the fuse box. Contact customer services.
- Parts and components on the appliance may have sharp edges. Wear protective gloves.
- Saucepans may suddenly move due to liquid between the pan base and the hotplate. Always keep the hotplate and saucepan bases dry.
- Incorrect repairs are dangerous. Repairs may only be carried out by a qualified electrician.
- Do not use any high-pressure cleaners or steam cleaners, which can result in an electric shock.
- Never use strong and abrasive cleaning agents as they will cause surface damage.
- In the event of a malfunction, turn off the appliance's electricity supply. For repairs, call customer services.
- This appliance complies with electromagnetic safety standards. However, persons with cardiac pacemakers or other electrical implants (such as insulin pumps) must consult with their doctor or implant manufacturer before using this appliance to make sure that their implants will not be affected by the electromagnetic field. Failure to follow this advice may result in death.
- Do not place or leave any magnetisable objects (e.g. credit cards, memory cards, etc.) or electronic devices (e.g. computers, MP3 players, etc.) near the appliance, as they may be affected by its electromagnetic field.

Product overview

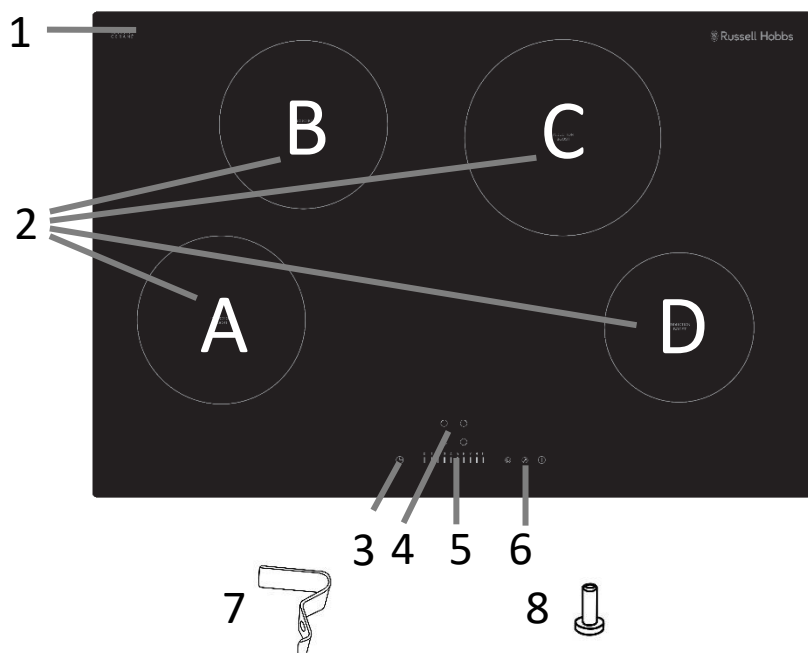

- | | |
|--|---|
| 1. Hob | 5. Power level controls |
| 2. Cooking zones | 6. Boost function control, child lock control & ON/OFF button |
| A. 1800W/2300W (max) | 7. 2 x Brackets |
| B. 1800W/2300W (max) | 8. 2 x Screws |
| C. 2200W/2600W (max) | |
| D. 1200W/1500W (max) | |
| 3. Timer indicator & control | |
| 4. Zone indicator controls & power level indicator | |

Unit & Spare Parts

If any of the above parts are missing please contact the customer service team on 0345 208 8750 or visit mda.russellhobbs.com

Positioning

- This appliance is to be installed in a counter top.
- Ensure no occurs to the appliance during installation.
- The appliance can only be used safely if it is correctly installed according to the safety instructions. The installer is responsible for ensuring that the appliance works correct when installed.
- **Electric ovens and hobs must be hard-wired to a suitably rated electrical cooker power point – it is recommended that you consult a qualified electrician. Failure to do so will invalidate your guarantee, liability claims and could lead to criminal prosecution.**
- The edges of the hob must be a minimum of 50mm from a side or rear wall.
- The highest point of the hob must be a minimum of 760mm from the underside of any surface **directly** above it.
- The highest point of the hob must be a minimum of 400mm from the underside of any surface **either side** of the hob. If any surface **either side** of the hob is lower than 400mm, then it must be at least 50mm from the outer edges of the hob.
- There must be a minimum of 50mm of clearance around the hob and any combustible materials.

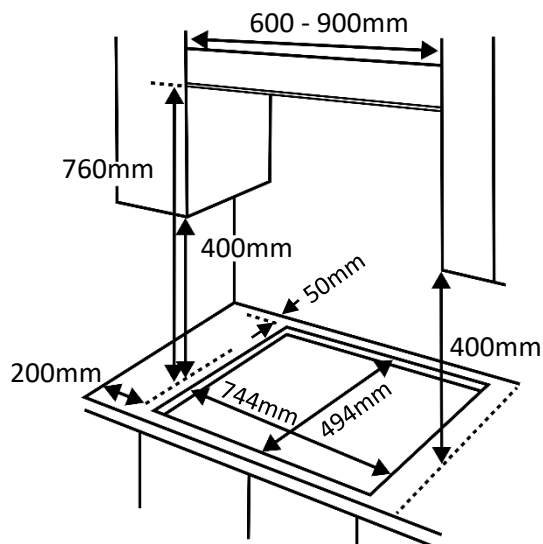

Positioning

- Be sure the thickness of the work surface is at least 30mm
- You must have a gap of a minimum gap of 25mm between the underside of the appliance and any surface below it.

Note:

- **Select heat-resistant work surface material to avoid larger deformation caused by the heat radiation from the appliance.**
- **To install a hob above an oven, the oven must have forced ventilation.**
- **Check the dimensions of the oven when being installed with the hob**

Installation

Preparation & installation

Ensure that there are no electric wires, gas or water pipes in the area where holes are to be made.

Components of the appliance may have sharp edges. Wear protective gloves.

1. Ensure that there is an electrical connection within adequate distance of the hob after it has been installed.
2. Cut out the aperture that measure 744mm by 494mm deep, in accordance with the positioning instructions detailed on the previous page.
3. Carefully and gently lower the hob into the aperture hole that you have cut out.
4. Fix the hob on the work surface by screwing the 2 brackets on to the underside of hob after installation:

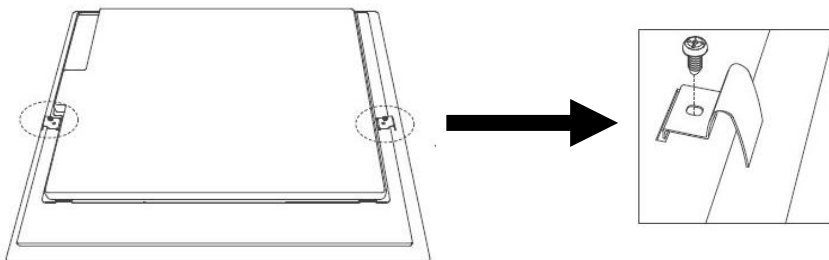

5. The brackets position can be adjusted to suit different thickness of work surfaces:

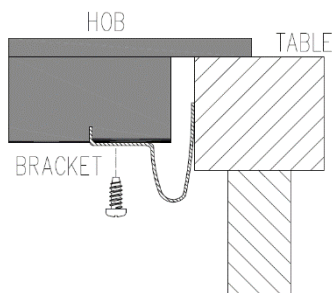

Installation

Electrical connection

- **WARNING-** THIS APPLIANCE MUST BE EARTHED
- This appliance is designed to be connected to a 220-240V~50Hz AC electricity supply.
- Before proceeding with the electrical connection, verify that the current carrying capacity of the system and the isolator / main switch is adequate for the maximum power rating of the hob.
- Electrical installation of the residence and of the appliance's isolator must be earthed and conform with the required safety regulations.
- If there is no suitable circuit and a fused switch, they must be installed by a qualified electrician before the hob is connected.
- An isolator switch must be easily accessible once the hob has been installed.
- Do not use adaptors, multiple sockets and/or extension leads.
- A circuit breaker with a contact opening of at least 3 mm, rated 32A and delayed functioning type must be installed inside the supply circuit.
- During installation, please ensure that insulated cables are used. An incorrect connection might damage your appliance and will void the manufacturer's guarantee.
- All repairs must be carried out by an authorised service personal or a qualified electrician.
- Switch off/isolate your appliance before each maintenance.
- Wiring diagram is below:

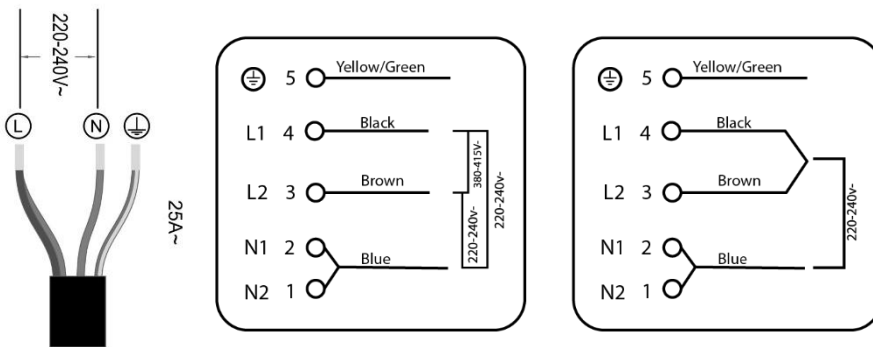

Induction introduction

Induction hobs only heat the pan rather than the cooking surface heating up like a standard electric hob. They do this by creating a magnetic field between the pan base and an element underneath the glass top; this makes induction hobs safer and cheaper to run as they use only the precise amount of energy you need.

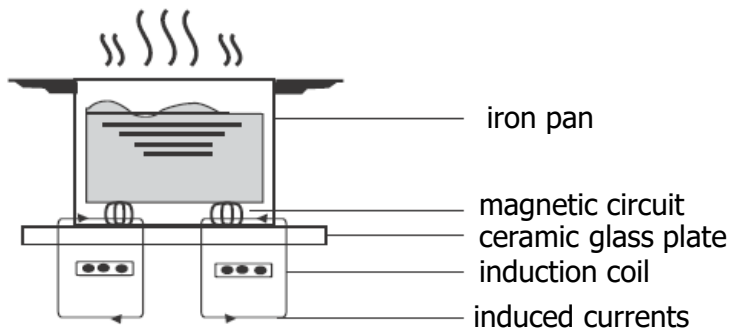

Because induction hobs create a magnetic field, pans need to either be made from a magnet metal such as cast iron or steel, or have a magnetic base. You can check whether your existing cookware is suitable by carrying out a magnet test: move a magnet towards the base of the pan. If it is attracted, the pan is suitable for induction. If you do not have a magnet then you can put some water in the pan you want to check, if the $\equiv \cup \leq$ symbol does not flash in the cooking zone indicator and the water is heating, the pan is suitable.

If your current cookware isn't suitable, then when purchasing new cookware you must ensure the packaging says they are compatible with induction hobs or that they pass the magnetic test detailed above. Please note cookware made from the following materials is not suitable: pure stainless steel, aluminum or copper without a magnetic base, glass, wood, porcelain, ceramic, and earthenware.

Note:

- **Because of the powerful electromagnetic field, induction may not be suitable if you have a pacemaker fitted**
- **The glass of an induction hob only becomes hot because the pan eventually warms it up**

Pans & Energy Saving

- Only use cookware with a base suitable for induction cooking. Look for the induction symbol on the packaging or on the bottom of the pan.
- You can check whether your cookware is suitable by carrying out a magnet test. Move a magnet towards the base of the pan. If it is attracted, the pan is suitable for induction.

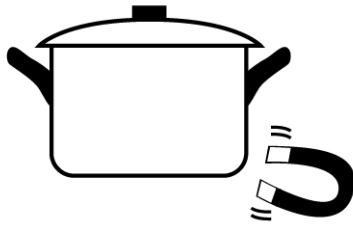





- If you do not have a magnet:
 - Put some water in the pan you want to check.
 - Follow the steps under 'To start cooking'.
 - If it does not flash in the display and the water is heating, the pan is suitable.
 - Cookware made from the following materials is not suitable: pure stainless steel, aluminium or copper without a magnetic base, glass, wood, porcelain, ceramic, and earthenware

The following advice is to prevent damage to pans and help you save energy:

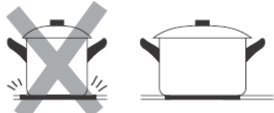
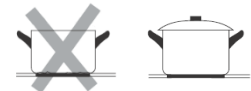
Zones	Suitable pan sizes (diameter)
1200W/1500W (max)	160mm
1800W/2300W (max)	180mm
1800W/2300W (max)	180mm
2200W/2600W (max)	210mm

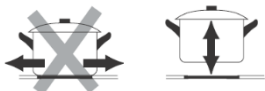
Pans & Energy Saving

X		✓
Do not use small pans on large zones		Always use pans that are the right size for each zone
Do not cook without a lid or with the lid half off, as this wastes energy		Place a lid on pans
Do not use damaged pans, which do not sit evenly on the hob: pans may tip over.		Only use pans with a thick, flat bottom
Do not use large pans on zones near the controls, as they may be damaged by the high temperatures		Always place pans centrally over the burners not to one side
Do not slide, or they may scratch the glass		Always lift pans off the hob
Do not use excessive weight or strike the hob with heavy objects		Be careful when handling pans when they are on the hob or have just been taken away from the burner

Usage

Controls

The appliance has 4 cooking zones and these are controlled by the touch controls at the bottom of the hob. Just above the cooking zone power controls there are the cooking zone selection controls and to the left of the cooking zone controls is the timer indicator:

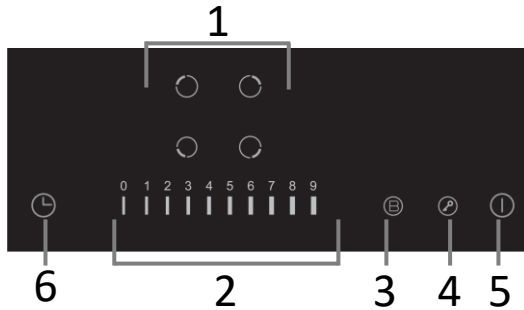

The function of each touch control and the meaning of each icon is explained below:



1 - Cooking zone selection controls and power level indicator



2 - Power level adjustment down and up



- Minimum power level: 0
- Maximum power level: 9



3 - Boost function



4 - Child lock



5 - Power on/off



6 - Timer indicator & control

Usage

Using the touch controls

The controls respond to touch, so you don't need to apply pressure to them. Below are tips on how to use the controls:

- Use the ball of your finger, not its tip.
- You will hear a beep each time a touch is registered.
- Make sure the controls are always clean, dry, and that there is no object (e.g. a utensil or a cloth) covering them. Even a thin film of water may make the controls difficult to operate.

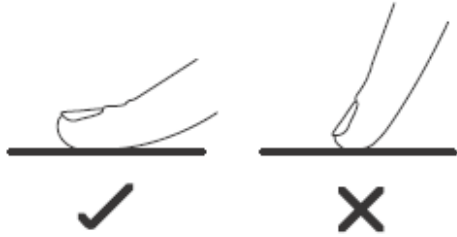

Indicators

Cooking zone indicators

The cooking zone indicators are next to the cooking zone controls. The indicator will show the power level of the zone, if a zone has any residual heat after operation and if it is being used with the timer.



Timer indicator

The timer indicator is located to the left of the power level controls. It will show the time that has been set for the minute minder and if one cooking zone is to be turned off after a period of time (maximum of 99 minutes).



Usage

Power levels

The settings below are guidelines only, the exact setting you will require will depend on several factors, including your cookware and the amount you are cooking. Experiment with the hob to find the settings that best suit you.

Heat setting	Suitability
1-2	Delicate warming for small amounts of food
	Melting chocolate, butter, and foods that burn quickly
	Gentle simmering
	Slow warming
3-4	Reheating
	Rapid simmering
	Cooking rice
5-6	Pancakes
7-8	Sautéing
	Cooking pasta
9	Stir-frying
	Searing
	Bringing soup to the boil
	Boiling water

Usage

To use a cooking zone

Note:

- When you touch a symbol, the respective function is activated.
- Always keep the controls dry. Moisture reduces their effectiveness.
- Do not pull pans close to the displays and sensors. The electronics could overheat.

Warnings:

- When it is first used, it is normal for the cooking zone to give off odours; this does not pose any risk and does not indicate a malfunction; they will disappear in time.
 - The kitchen will become hot and humid when this appliance is used. You must therefore ensure that the kitchen is well ventilated: either keep the natural ventilation apertures open, or install a ventilation system (extractor hood).
 - If using the appliance intensively for prolonged periods, you may require additional ventilation (e.g. by opening a window) or more effective ventilation (e.g. by increasing the hob's ventilation, if possible).
1. Turn on the appliance at the circuit, the appliance will beep and all indication lights will flash and then go out.
 2. Touch the power on/off control , all indicators will display a '-' symbol.
 3. Place a suitable pan on the cooking zone that you wish to use.
 1. Make sure the bottom of the pan and the surface of the cooking zone are clean and dry.

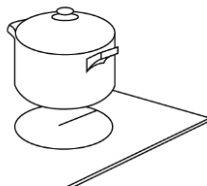

Usage

4. Select the cooking zone you want by touching the required cooking zone control and the indicator of the zone you have selected will flash.

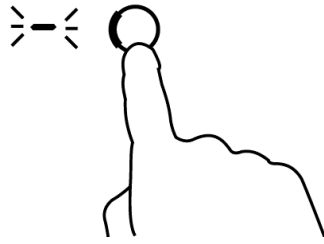

5. Use the power level controls to select the required power, this will be shown on the cooking zone indicator of the cooking zone that is being used.

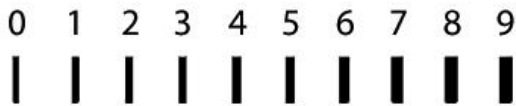

6. Please note that if a power level is not selected within 5 seconds of touching the required cooking zone control it will be deselected. You will need to retouch the required cooking zone again and select the power level you require. If a cooking zone and power level is not selected within 1 minute of powering on the hob, the hob will automatically switch off. If this happens then you will need to start again from step 2.

Note: If a cooking zone indicator flashes with the $\geq \cup \leq$ symbol, this means:

- i. You have not placed a pan on the correct cooking zone
- ii. The pan you're using is not suitable for induction cooking
- iii. The pan is too small or not properly centred on the cooking zone.

No heating takes place unless there is a suitable pan on the cooking zone. The display will automatically turn off after 1 minute if no suitable pan is placed on it.

Usage

7. To switch the cooking zone off, you can either touch the 0 power level indicator line (after touching/selecting the required cooking zone control) and ensure '0' is shown in the cooking zone indicator. Alternatively you touch the power  control and turn the hob off completely.

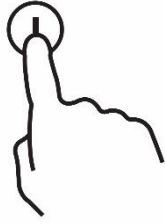

9. The 'H' symbol will be shown on the indicator of the cooking zone that have just been used to show that there is residual heat on that cooking zone. The 'H' symbol will stay lit until the cooking zone has cooled down sufficiently. It can also be used as an energy saving function if you want to heat an additional pan or keep the contents of a pan warm, use the zone that is still hot.



Usage

Boost function

The function is available on all cooking zones and will increase the power of the selected zone to its maximum power.

1. Follow steps 1 – 5 from pages 17 and 18.
2. Touch the cooking zone control you want to apply the boost function (maximum power) to. The power level indicator will flash.
3. Touch the Boost control 'ⓑ', the cooking zone indicator will show a "b" and the power of the cooking zone will be set to its maximum level for 5 minutes before reverting back to its original setting.



4. To deactivate the Boost function, touch the cooking zone that the Boost function is applied to on the cooking zone selection control.



5. Touch the "ⓑ" control and the Boost function will be cancelled, the cooking zone will revert back to its original setting and the power level indicator will flash.



Usage

- The Boost function can work in any cooking zone
- The Boost function can be set to 2 cooking zones at the same time if required. 1 of cooking zones A or B can be set and 1 cooking zone from C or D can be set
Note that this will mean that the maximum power level setting of the other 2 zones can be setting 2 if they are in use or powered on.
- The cooking zone returns to its original setting after 5 minutes.
- If the original heat setting equals 2, it will return to setting 2 after 5 minutes (when the boost function stops).



Locking the controls

You can lock the controls to prevent unintended use (for example children accidentally turning the cooking zones on).

To lock the controls touch the child lock  control, the timer indicator will show 'Lo'.

Note: When the controls are locked, all the controls except the Power on/off control are disabled. If the hob is turned off when the controls have been locked you will have to unlock the controls when the hob is powered on.

To unlock the controls touch and hold the  control for at least 3 seconds. All controls can now be unlocked and can be used.

When the hob is in the lock mode, all the controls are disabled except the ON/OFF  , you can always turn the induction hob off with the ON/OFF  control in an emergency, but you shall unlock the hob first in the next Operation.

Usage

Using the Timer

You can use the timer in two different ways:

1. As a minute minder - in this case, the timer will not turn any cooking zone off when the set time is up.
2. To turn one cooking zone off after the set time is up.

Note: You can set the timer for up to 99 minutes.

Using the Timer as a Minute Minder

To use the minute minder, the hob must be working (so at least 1 cooking zone is working). If you're not selecting any cooking zone, the hob will automatically switch off after 1 minute.

1. Select a cooking zone and select the required power level that is required. Then wait at least 5 seconds before moving to step 2.
2. Touch the timer controls/indicator , "10" will show on the timer display and the "0" will start flashing



3. Set the time by touching power controls.



3. Touch the timer controls/indicator again. The "1" will flash.



Usage

4. Set the time by touching power controls. Once you have selected your required time do not press another button and the timer will be set.



5. When the time is set, it will begin to count down immediately. The display will show the remaining time and the timer indicator will flash for 5 seconds.



6. When the time has counted down the hob will beep for 30 seconds and the timer indicator will show '- -'. Please note if you want to change the time after the timer is set, you have to cancel the timer function and start from step 1.



7. If you want to cancel the timer at any point you can do this by touching the power  control. The timer will be cancelled.

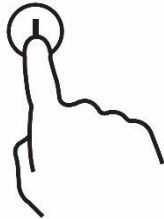

Usage

Setting the timer to turn one cooking zone off

Make sure the hob is turned on and that a suitable pan has been placed on the zone you wish to use. Make sure the bottom of the pan and the surface of the pan support are clean and dry.

1. Select required cooking zone by touching the required cooking zone control and the indicator of the zone you have selected will flash.
2. Use the power level controls to select the required power, this will be shown on the cooking zone indicator of the cooking zone that is being used.
3. Touch the timer controls/indicator within 5 seconds (if it is touched after 5 seconds the timer will not be set, the minute minder will be set), "10" will show on the indicator and the "0" will flash.



4. Set the time by touching the power controls.



5. Touch the timer controls/indicator again, the "1" on the timer indicator will flash.



Usage

6. Set the time by touching power controls.



7. When the time is set, it will begin to count down immediately. Please note that the red dot next to power level indicator will illuminate indicating that zone is selected. The display will show the remaining time and the timer indicator will flash for 5 seconds.



8. When the time has counted down the hob will beep once, the timer indicator will show '- -' and the cooking zone will turn off. Please note if you want to change the time after the timer is set, you have to cancel the timer function and start from step 1.



9. If you want to cancel the timer at any point you can do this by touching the power  control. The timer will be cancelled.

Usage

If the timer is set on more than one zone

1. When you set the time for multiple cooking zones simultaneously, the dots of the relevant cooking zones are on. The minute display shows the time of the lowest time that has been set. Touch the cooking zone that has a timer set on cooking zone selection control, the corresponding timer will be shown in the timer indicator.

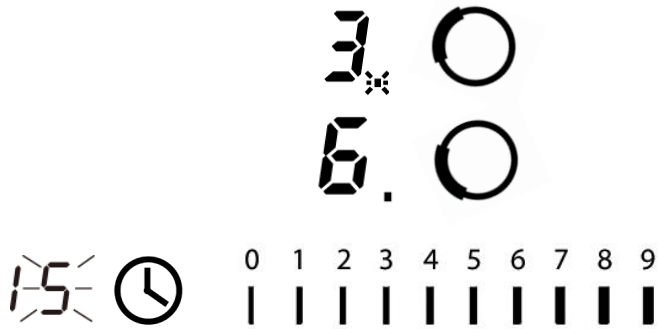

2. Once the countdown timer expires, the corresponding zone will switch off. Then it will show the new min. timer and the dot of corresponding zone will be lit.

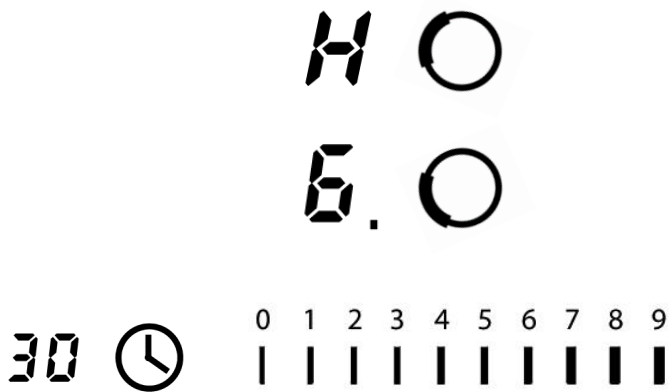

Usage

Cancel the timer

1. Touching the heating zone selection control that you want to cancel the timer

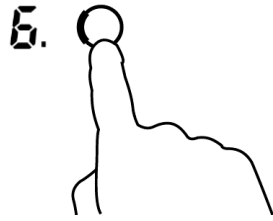

2. Touching the timer control, the indicator flash

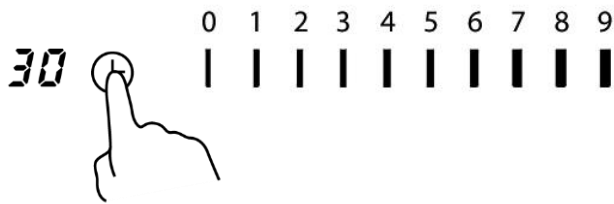

3. Touch the slider control to set the timer to "00", the timer is cancelled

Usage

Residual heat warning

When the hob has been operated there will be some residual heat. The display of controls of which ever cooking zone has been used will show a 'H' symbol to warn you of the residual heat and to keep away from it.

The 'H' symbol will stay lit until the cooking zone has cooled down sufficiently.

Over heat protection

The hob is fitted with a temperature sensor which can monitor the temperature inside the induction hob. If an excessive temperature is detected then the hob will stop operation automatically and switch itself off.

Auto shutdown

Another safety feature of the hob is an auto shutdown, this occurs if you ever forget to switch off a cooking zone and certain time has passed. The shutdown times are shown in the table below:

Power level	1	2	3	4	5	6	7	8	9
Default working timer (hour)	8	8	8	4	4	4	2	2	2

Cooking zone wattages and sizes

Zones	Suitable pan sizes (diameter)
1200W/1500W (max)	160mm
1800W/2300W (max)	180mm
1800W/2300W (max)	180mm
2200W/2600W (max)	210mm

Usage

Cooking recommendations:

The following advice is to help you get the best cooking performance/results:

Zone	Very high, High	Medium	Low
1800W - 2600W (max)	Boiling, steaming, griddling, toasting, paellas, Asian food (wok).	Reheating and keeping things hot: cooked and pre-cooked dishes.	
	Escalopes, steaks, omelettes, frying.	Rice, white sauce and ragout.	Steaming: fish, vegetables.
1200W - 1500W (max)	Steamed potatoes, fresh vegetables, stews, pasta, etc.	Reheating and keeping things hot: pre-cooked dishes and delicate casseroles.	
	Casseroles, rice pudding and caramels.	Defrosting and slow cooking: vegetables, fruits and frozen products.	Melting: butter, chocolate, gelatine

Usage

Cooking guidelines:

Cooking Tips

- When food comes to the boil, reduce the temperature setting.
- Using a lid will reduce cooking times and save energy by retaining the heat.
- Minimise the amount of liquid or fat to reduce cooking times.
- Start cooking on a high setting and reduce the setting when the food has heated through.

Simmering, cooking rice

- Simmering occurs below boiling point, at around 85°C, when bubbles are just rising occasionally to the surface of the cooking liquid. It is the key to delicious soups and tender stews because the flavours develop without overcooking the food. You should also cook egg-based and flour thickened sauces below boiling point.
- Some tasks, including cooking rice by the absorption method, may require a setting higher than the lowest setting to ensure the food is cooked properly in the time recommended.

Searing steak

1. Stand the meat at room temperature for about 20 minutes before cooking.
2. Heat up a heavy-based frying pan.
3. Brush both sides of the steak with oil. Drizzle a small amount of oil into the hot pan and then lower the meat onto the hot pan.
4. Turn the steak only once during cooking. The exact cooking time will depend on the thickness of the steak and how cooked you want it. Times may vary from about 2 – 8 minutes per side. Press the steak to gauge how cooked it is – the firmer it feels the more 'well done' it will be.
5. Leave the steak to rest on a warm plate for a few minutes to allow it to relax and become tender before serving.

Usage

For stir-frying

1. Choose an induction compatible flat-based wok or a large frying pan.
2. Have all the ingredients and equipment ready. Stir-frying should be quick. If cooking large quantities, cook the food in several smaller batches.
3. Preheat the pan briefly and add two tablespoons of oil.
4. Cook any meat first, put it aside and keep warm.
5. Stir-fry the vegetables. When they are hot but still crisp, turn the cooking zone to a lower setting, return the meat to the pan and add your sauce.
6. Stir the ingredients gently to make sure they are heated through.
7. Serve immediately.

Cleaning and Maintenance:

Important notes:

- The appliance will become hot during operation, allow the appliance to cool down before cleaning.
- Do not use any high-pressure cleaners or steam cleaners.
- Wash new sponge cloths thoroughly before use.
- Follow all instructions and warnings included with the cleaning agents.

How to clean

Observe the information below to ensure the surfaces are not damaged by using the wrong type of cleaning agent. Do not use:

- Harsh or abrasive cleaning agents,
- Cleaning agents with a high concentration of alcohol,
- Hard scouring pads or sponges,
- High-pressure cleaners or steam cleaners.

Surface type	How to clean
Glass	Glass cleaner: Clean with a soft cloth. Do not use a glass scraper.

- After each use, clean the surface of each zone once they have cooled down. If any residue is left (baked-on food, drops of grease etc.), however little, it will become stuck to the surface and more difficult to remove later.
- Always clean off any liquid as soon as it is spilt: you will save yourself any unnecessary effort.
- Do not leave acidic liquids (e.g. lemon juice, vinegar, etc.) on the hob.
- Where possible, do not allow salt to come into contact with the surface of the electric hob.

Cleaning and Maintenance:

<p>Everyday soiling on glass (fingerprints, marks, stains left by food or non-sugary spillovers on the glass)</p>	<ol style="list-style-type: none"> 1. Switch the power off the hob 2. Apply a hob cleaner while the glass is still warm (but not hot!) 3. Rinse and wipe dry with a clean cloth or paper towel. 4. Switch the power on the hob. 	<ul style="list-style-type: none"> • When the power to the hob is switched off, there will be no 'hot surface' indication but the cooking zone may still be hot! Take extreme care. • Heavy-duty scourers, some nylon scourers and harsh/abrasive cleaning agents may scratch the glass. Always read the label to check if your cleaner or scourer is suitable. • Never leave cleaning residue on the cooktop: the glass may become stained.
<p>Boil overs, melts and hot sugary spills on the glass</p>	<p>Remove these immediately but beware of hot cooking zone surfaces:</p> <ol style="list-style-type: none"> 1. Switch the power to the cooktop off at the wall. 2. Hold the blade or utensil at a 30° angle and scrape the soiling or spill to a cool area of the cooktop. 3. Clean the soiling or spill up with a dish cloth or paper towel. 4. Follow steps 2 to 4 for 'Everyday soiling on glass' above. 	<ul style="list-style-type: none"> • Remove stains left by boil overs, melts and sugary food as soon as possible. If left to cool on the glass, they may be difficult to remove or even permanently damage the glass surface. • Cut hazard: when the safety cover is retracted, the blade in a scraper is razor-sharp. Use with extreme care and always store safely and out of reach of children.
<p>Spillovers on the touch controls</p>	<ol style="list-style-type: none"> 1. Switch the power to the cooktop off. 2. Soak up the spill 3. Wipe the touch control area with a clean damp sponge or cloth. 4. Wipe the area completely dry with a paper towel. 5. Switch the power to the cooktop back on. 	<ul style="list-style-type: none"> • The cooktop may beep and turn itself off, and the touch controls may not function while there is liquid on them. • Make sure you wipe the touch control area dry before turning the cooktop back on.

Cleaning and Maintenance:

Causes of damage:

- Rough pot and pan bases scratch the ceramic.
- Avoid boiling pots dry. This may cause damage.
- Sugar can cause the surface to blister if not removed immediately
- Never place hot pots or pans on the control panel, the display area or the surround. This may cause damage.
- Damage can occur if hard or pointed objects fall on the hob.
- Aluminium foil and plastic containers melt on hot hotplates.
- Oven protective foil is not suitable for your hob.
- Unsuitable cleaning agents can cause discolouration and/or stains.
- Spillages can cause discolouration if not removed/cleaned immediately.
- Dragging or scraping pans across the hob can cause discolouration, pans should be lifted when moving them

Trouble Shooting:

Problem	Solution
No power	The circuit breaker is defective or turned off check circuit breaker is in working order and that it is not switched off.
	Power cut or faulty fuse Check whether other kitchen appliances are working or check in the fuse box to make sure that the fuse for the appliance is working
Controls aren't working	The child lock/control lock is operational Unlock the child lock/control lock
Scratches, discolouration or blistering	Sliding or dragging pans may scratch the glass Always lift pans off the hob
	Rough pot and pan bases scratch the ceramic Replace cookware
	Spillages can cause discolouration Remove/clean all spillages immediately
	Sugar can cause the surface to blister Remove/clean all spillages immediately
Cookware is damaged	Cookware can become deformed if boiled dry Never boil pans dry

Fault codes:

The hob is equipped with a self diagnostic function and the table below shows the fault codes and the actions that should be taken.

Failure code	Problem	Solution
Auto-Recovery		
E1	Supply voltage is above the rated voltage.	Please inspect whether power supply is normal.
E2	Supply voltage is below the rated voltage.	Power on after the power supply is normal.
E3	High temperature of ceramic plate sensor	Wait for the temperature of ceramic plate return to normal. Touch "ON/OFF" button to restart unit.
E4	High temperature of ceramic plate sensor.	
E5	High temperature of IGBT .	Wait for the temperature of IGBT return to normal. Touch "ON/OFF" button to restart unit. Check whether the fan runs smoothly; if not , then contact customer services.
E6	High temperature of IGBT	
No Auto-Recovery		
F3/F6	Ceramic plate temperature sensor failure.	Contact customer services
F4/F7	Ceramic plate temperature sensor failure.	
F5/F8	Ceramic plate temperature sensor failure.	
F9/FA	Temperature sensor of the IGBT failure.	
FC /FD	Temperature sensor of the IGBT failure.	

Guarantee

This product is guaranteed for 12 months from the date of the original purchase. If any defect arises due to faulty materials or workmanship you must contact Product Care with the original proof of purchase so a replacement or refund can be arranged.

Refund or replacement is at the discretion of Product Care.

The following conditions apply:

- Product Care will require a valid proof of purchase at the point of replacement or refund.
- The product must be installed and used in accordance with the instructions contained in this instruction guide and any other instructions for use which has been supplied.
- It must be used for domestic purposes only and for its intended use.
- This guarantee does not cover wear and tear, damage, misuse or consumable parts.

This does not affect your statutory rights.

Technical Specification

Model number	RH77IH501B
Rated Voltage	220V – 240V ~ 50Hz
External Dimensions(HxWxD)	60mm x 770mm x 520mm

Notes



Russell Hobbs

Russell Hobbs is a registered trademark used under license from Spectrum Brands (UK) Ltd. Made under license by G2S Limited, Wigan, WN2 4AY/G2S (NI) Ltd, Belfast, BT5 5AD.

Russell Hobbs Support: call **0345 208 8750** or visit: mda.russellhobbs.com

**UK
CA**

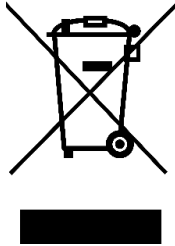

The 'wheelie bin' symbol is known as the 'Crossed-out wheelie bin Symbol'. When this symbol is marked on a product/batteries, it means that the product/batteries should not be disposed of with your general household waste. Only discard electrical/electronic/battery items in separate collection schemes, which cater for the recovery and recycling of materials contained within. Your co-operation is vital to ensure the success of these schemes and for the protection of the environment. For your nearest disposal facility, visit www.recycle-more.co.uk or ask in store for details.

SEDEX – Connecting businesses and their global suppliers to share ethical data and enabling improvement in ethical performance. Visit www.sedex.org.uk for further information.

We reserve the right, due to possible changes to design, to alter the instruction manual without prior notice.

Revision 2