

This Owner's Manual is provided and hosted by [Appliance Factory Parts](#).



# Russell Hobbs RH60GH402SS Owner's Manual

[Shop genuine replacement parts for Russell Hobbs  
RH60GH402SS](#)



[Find Your Russell Hobbs Cooker Parts - Select From 29 Models](#)

----- Manual continues below -----



# Russell Hobbs

## Gas Hob Instruction Manual

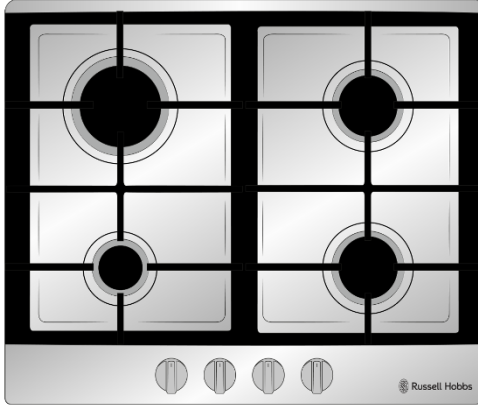

**Model number(s):**  
RH60GH402SS

For Customer Services & Spare Parts please call **0345 208 8750**  
or visit us at <https://mda.russellhobbs.com>

**IMPORTANT:**  
**RETAIN FOR FUTURE REFERENCE**

# Contents

<b>Safety Instructions</b>	.....	<b>3-5</b>
<b>Product Overview</b>	.....	<b>6</b>
<b>Positioning</b>	.....	<b>7-8</b>
<b>Installation</b>	.....	<b>9-13</b>
<b>Usage</b>	.....	<b>14-17</b>
<b>Cleaning &amp; Maintenance</b>	.....	<b>18-20</b>
<b>Trouble shooting</b>	.....	<b>21-23</b>
<b>Connection to the mains</b>	.....	<b>24</b>
<b>Guarantee</b>	.....	<b>25</b>
<b>Technical specification</b>	.....	<b>26</b>
<b>Notes</b>	.....	<b>27</b>

# Safety Instructions

## Important note:

Please read this booklet before installing and switching on this appliance. The manufacturer assumes no responsibility for incorrect installation and usage as described in this booklet.

**This appliance can be used by children aged from 8 years and above and persons with reduced physical, sensory or mental capabilities or lack of experience and knowledge if they have been given supervision or instruction concerning use of the appliance in a safe way and understand the hazards involved. Children shall not play with the appliance.**

**Gas appliances must be disconnected and installed by a Gas Safe registered engineer. This scheme has replaced the Corgi registration scheme. For details visit [www.gassaferegister.co.uk](http://www.gassaferegister.co.uk) or call 0800 408 5500. Failure to do so will invalidate your guarantee, liability claims and could lead to criminal prosecution**

**The use of a gas cooking appliance results in the production of heat, moisture and products of combustion in the room in which it is installed. Ensure that the kitchen is well ventilated especially when the appliance is in use: keep natural ventilation holes open or install a mechanical ventilation device (mechanical extractor hood).**

**In case of glass or steel hotplate breakage: shut immediately off all burners and any electrical heating element and isolate the appliance from the power supply. Do not touch the appliance surface and do not use the appliance.**

- Children should be supervised to ensure that they do not play with the appliance.
- If the supply lead is damaged it must be replaced by a qualified person using the correct lead, available from **0345 208 8750**.

## Safety Instructions

- Packaging material is dangerous to children. Never allow children to play with packaging material.
- Check the appliance for damage after unpacking it. Do not connect the appliance if it has been damaged in transport.
- The appliance can only be used safely if it is correctly installed according to the safety instructions. The installer is responsible for ensuring that the appliance works correctly after installation.
- All operations relating to installation, regulation and conversion to other types of gas must be carried out by an authorised installation engineer, respecting applicable regulations, standards and the specifications of the local gas and electricity providers.
- You are recommended to contact the Technical Assistance Service to convert to another type of gas. Before installing your new hob, ensure that it is being installed according to the assembly instructions.
- Prior to installation, ensure that the local distribution conditions (nature of the gas and gas pressure) and the adjustment of the appliance are compatible.
- The adjustment conditions for this appliance are stated on the rating label.
- This appliance is not connected to a combustion products evacuation device. It shall be installed and connected in accordance with current installation regulations. Particular attention shall be given to the relevant requirements regarding ventilation.
- This appliance can only be installed in a well-ventilated place in accordance with existing regulations and ventilation specifications.
- The appliance must not be connected to a combustion product removal device.
- Do not subject the appliance to draughts. These might blow out the burners.
- This appliance leaves the factory set to the type of gas that is indicated on the specifications plate. If this must be changed, read the assembly instructions.
- Do not tamper with the appliance's interior. If necessary, call our customer helpline
- Do not switch on the appliance if it is damaged in any way. Contact our customer helpline
- This appliance is only intended for cooking purposes, not as a heating system.

## Safety Instructions

- Do not leave the appliance unattended during operation. The manufacturer is not liable for damage which is caused by improper use or incorrect operation.
- Hot oil and fat can ignite very quickly. Never leave hot fat or oil unattended. Never use water to put out burning oil or fat. Switch off the appliance. Extinguish flames carefully using a lid, fire blanket or something similar.
- When gas burners are in operation without any cookware placed on them, they can build up a lot of heat. Only operate the gas burners with cookware on them.
- Operating several gas burners at the same time gives rise to a great deal of heat.
- The accessible parts become very hot when in operation. Never touch hot parts. Keep children at a safe distance.
- Do not use covers. These can cause accidents, due to overheating, catching fire or materials shattering, for example.
- Do not use inappropriate child safety shields or hob guards. These can cause accidents.
- The hob will become very hot. Never place combustible items on the hob. Never place objects on the hob.
- Incorrect repairs are dangerous. Repairs may only be carried out by a gas safe registered engineer
- Components inside the appliance may have sharp edges. Wear protective gloves.
- Do not use any high-pressure cleaners or steam cleaners, which can result in an electric shock.
- Never use strong and abrasive cleaning agents as they will cause surface damage.
- In the event of a malfunction, turn off the appliance's gas and electricity supply. For repairs, call customer services
- Warning: Do not use cooking vessel on the cooking zones that overlap its edges
- Warning: Do not use hob guards, inappropriate use of hob guards can cause accidents.

## Product overview

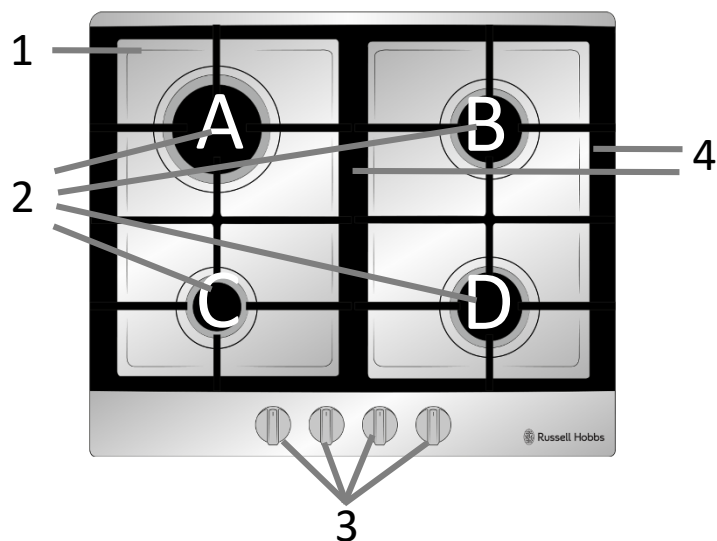

- |                       |                    |
|-----------------------|--------------------|
| 1. Hob                | 4. 2 x Pan support |
| 2. Burners            | 5. 4 x Sponge      |
| A. Rapid burner       | 6. 4 x Bracket     |
| B. Semi rapid burners | 7. 4 x Screws      |
| C. Auxiliary burner   | 8. 4 x Injector    |
| D. Semi rapid burners | 9. Gas pipe bend   |
| 3. Dials              |                    |

### Unit & Spare Parts

If any of the above parts are missing please contact the customer service team on 0345 208 8750 or visit <https://mda.russellhobbs.com>

 Russell Hobbs

## Positioning

- This appliance is to be installed in a counter top.
- Avoid damaging the product during installation.
- The appliance can only be used safely if it is correctly installed according to the safety instructions. The installer is responsible for ensuring that the appliance works correct when installed.
- **Gas appliances must be disconnected and installed by a Gas Safe registered engineer. This scheme has replaced the Corgi registration scheme. For details visit [www.gassaferegister.co.uk](http://www.gassaferegister.co.uk) or call 0800 408 5500. Failure to do so will invalidate your guarantee, liability claims and could lead to criminal prosecution.**
- The edges of the hob must be a minimum of 60mm from a side or rear wall.
- The highest point of the hob (including the burners) must be a minimum of 700mm from the underside of any surface **directly** above it.
- The highest point of the hob (including the burners) must be a minimum of 400mm from the underside of any surface **either side** of the hob. If any surface **either side** of the hob is lower than 400mm, then it must be at least 50mm from the outer edges of the hob.
- There must be a minimum of 50mm of clearance around the hob and any combustible materials.

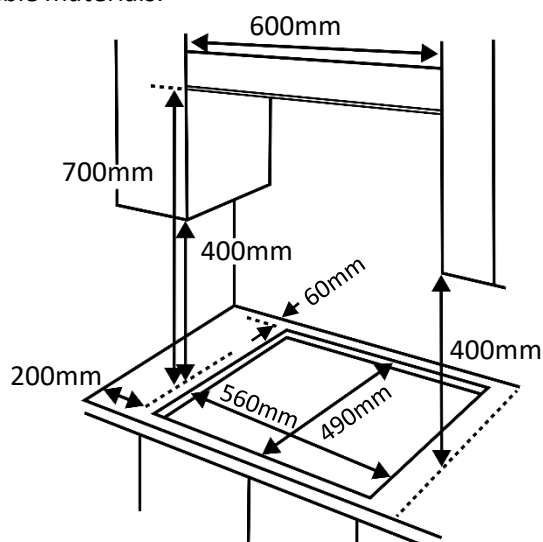

 Russell Hobbs

## Positioning

- You must have a gap of a minimum gap of 25mm and a maximum gap of 74mm between the underside of the appliance and any surface below it.

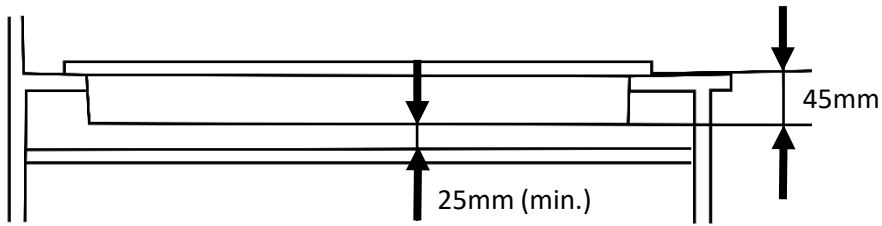

### Note:

- **Select heat-resistant work surface material to avoid larger deformation caused by the heat radiation from the appliance.**
- **To install a hob above an oven, the oven must have forced ventilation.**
- **Check the dimensions of the oven when being installed with the hob**

# Installation

## Preparation & installation

Ensure that there are no electric wires, gas or water pipes in the area where holes are to be made.

Components of the appliance may have sharp edges. Wear protective gloves.

1. Ensure that there is an electrical plug socket and gas supply within adequate distance of the hob after it has been installed.
2. Cut out the aperture that measure 560mm by 490mm deep, in accordance with the positioning instructions detailed on the previous page.
3. Remove the pan supports, burner lid, flame spreader and carefully turn the appliance upside down and place it on a cushioned mat.
4. Apply the sponge provided around the edge of the appliance: the thickness of the sponge is 3mm and width of it is 10mm.
5. Do not leave a gap in the sealing agent or overlap the thickness
6. Place the bracket over the holes in each corner of the hob that match the size of the screws that have been provided.
7. Slightly tighten a screw through the bracket so that the bracket is attached to the hob: you should still be able to adjust the position of the bracket.
8. Carefully turn the hob back over and gently lower it into the aperture hole that you have cut out
9. On the underside of the hob, adjust the brackets into a position that is suitable for your worktop.
10. Fully tighten the screws to secure the hob into position

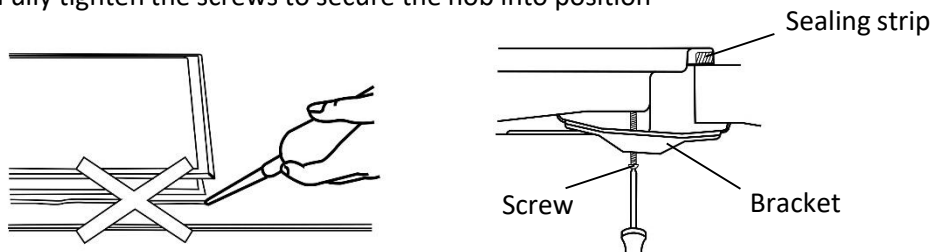

**Note: Do not use silicon sealant to seal the appliance against the aperture, as this will make it difficult to remove the appliance in the future.**

 Russell Hobbs

# Installation

## Gas connection

- Gas appliances must be disconnected and installed by a Gas Safe registered engineer. This scheme has replaced the Corgi registration scheme. For details visit [www.gassaferegister.co.uk](http://www.gassaferegister.co.uk) or call 0800 408 5500. Failure to do so will invalidate your guarantee, liability claims and could lead to criminal prosecution.
- This appliance is supplied to run on LPG and natural gas, conversion to LPG or natural gas must be undertaken by a Gas Safe registered engineer. This scheme has replaced the Corgi registration scheme. For details visit [www.gassaferegister.co.uk](http://www.gassaferegister.co.uk) or call 0800 408 5500. Failure to do so will invalidate your guarantee, liability claims and could lead to criminal prosecution

### Gas supply replacement and installation guidelines

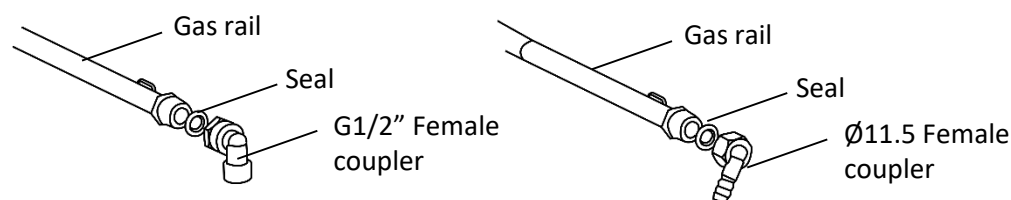

## Electrical connection

- This appliance is designed to be connected to a 220-240V~50Hz AC electricity supply.
- Before proceeding with the electrical connection, verify that the current carrying capacity of the system and the isolator / main switch is adequate for the maximum power rating of the hob.
- Electrical installation of the residence and of the appliance's isolator must be earthed and conform with the required safety regulations.

# Installation

- If there is no suitable circuit and a fused switch, they must be installed by a qualified electrician before the hob is connected.
- Do not use adaptors, multiple sockets and/or extension leads.
- During installation, please ensure that insulated cables are used. An incorrect connection might damage your appliance and will void the manufacturer's guarantee.
- All repairs must be carried out by an authorised service personal or a qualified electrician.
- Switch off/isolate your appliance before each maintenance.

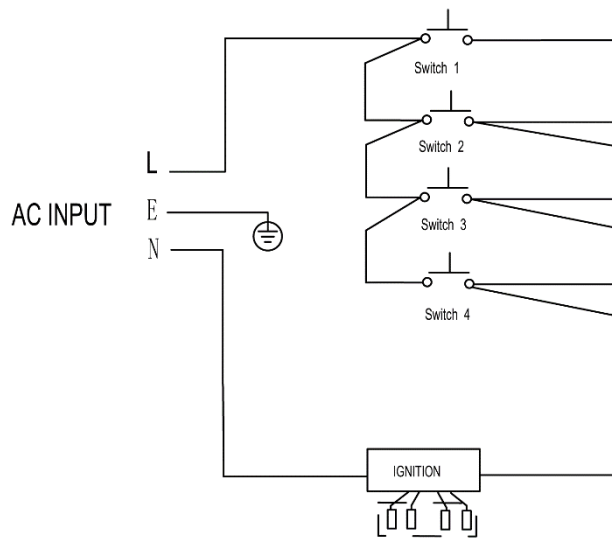

# Installation

## Gas adjustment

Before any adjustment is started the gas and electricity supply to the appliance must be turned off.

## Change the injector of the burners

- Remove the pan support, burner cover and flame spreader
- Unscrew the injector using a spanner and replace it with the stipulated injector for the new gas supply.
- Carefully reassemble all of the components.
- After the injectors are replaced, you must ensure the replacement injectors are fully tightened.

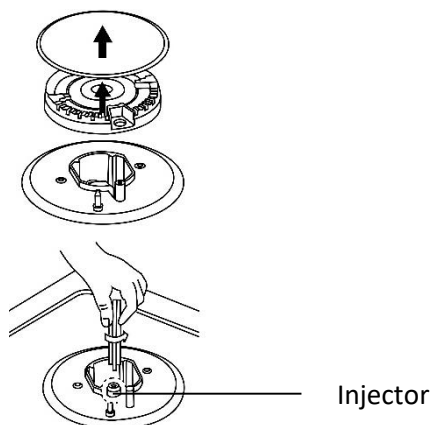

## Adjustment of the minimum flame level

- Turn the taps down to the minimum level
- Remove the dial from the tap and place a small bladed screw driver in the centre of the tap shaft
- The correct adjustment is obtained when the flame has a length of 3mm - 4mm (for butane/propane gas the adjustment screw must be tightly screwed in).

## Installation

- Refit the dial and make sure that the flame does not go out by quickly turning from maximum flame to minimum flame. If it does then remove the dial and make further adjustments to the gas flow, testing it again once the adjustment has been made.
- Repeat this process for each one of the dials/gas taps

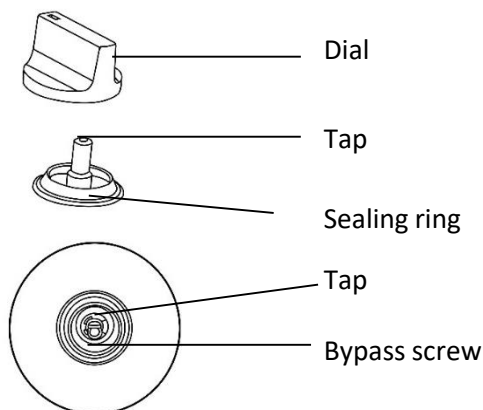

### Note:

- Do not dismantle the tap shaft, in the event of a malfunction change the whole tap.
- Before placing the burners back, make sure that the injector is not blocked.
- A full operational test and leakage test must be carried out after a gas conversion.
- After completing a conversion a qualified installer must mark a "V" on the correct gas category to match with the setting in the rating label (remove the previous "V" mark)

# Usage

Note: The appliance is fitted with a flame failure safety device on each burner, which is designed to stop the flow of gas to the burner head in the event of the flame going out.

## Dials

The appliance has 4 dials and these control the 4 burners, at the bottom left of each dial there is an illustration that shows the burner that each dial controls:

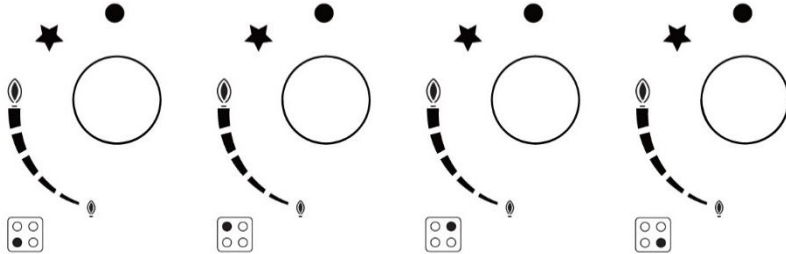

Each dial has 4 icons. these are explained below:

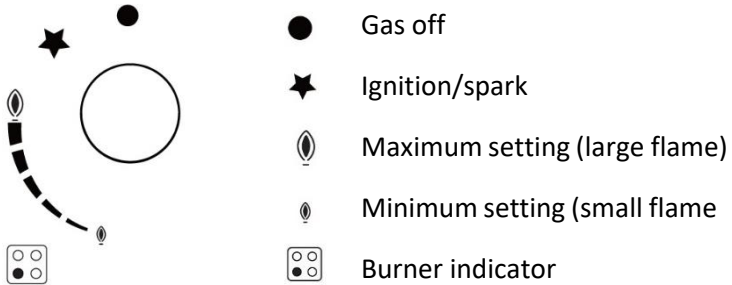

## To use a burner

1. Turn on the appliance at the plug.
2. Place a suitable pan on the pan support that is over the burner you wish to use. Make sure the bottom of the pan and the surface of the pan support are clean and dry.
3. Press the dial of the burner that you wish to light downwards and turn it anti-clockwise to the maximum setting (large flame).

 Russell Hobbs

## Usage

3. You must keep the dial depressed so that the automatic ignition for the burner operates.
4. You should hold down the control knob for 15 seconds after the flame has ignited on the burner. If after 15 seconds the burner has not lit, stop operating the device and wait at least 1 min before trying to ignite the burner again.
5. After this 15-second interval, you will be able to release the dial and set the flame to your required level by turning the dial anti-clockwise.
6. The operating position **MUST** be at a position between the maximum and minimum position.
7. To switch the burner off, turn the control dial clockwise to the gas off position.

**Note: In case of power cut, the burners can be lit carefully by using a match.**

### Warnings:

- It is normal to hear a slight whistling noise while the burner is operating.
- When it is first used, it is normal for the burner to give off odours; this does not pose any risk and does not indicate a malfunction; they will disappear in time.
- A few seconds after the burner is switched off, a sound (thud) will be produced. This is not a fault - this means that the safety device is no longer operating.
- Keep the burner as clean as possible. If the ignition sparkers are dirty they will not light properly. Clean them periodically using a small non-wire brush. Bear in mind that the ignition sparkers must not suffer any serious impacts.
- An orange-coloured flame is normal. This is caused by the presence of dust in the atmosphere, spilt liquids, etc.
- The kitchen will become hot and humid when this gas appliance is used. You must therefore ensure that the kitchen is well ventilated: either keep the natural ventilation apertures open, or install a ventilation system (extractor hood).
- If using the appliance intensively for prolonged periods, you may require additional ventilation (e.g. by opening a window) or more effective ventilation (e.g. by increasing the hob's ventilation, if possible).
- If the burner flames are accidentally blown out, switch off the burner operating control knob and do not try to relight it for at least one minute.



# Usage

## Pans & energy saving

The following advice is to prevent damage to pans and help you save energy:

Burners	Suitable pan sizes (diameter)	
	Minimum diameter (mm)	Maximum diameter (mm)
<b>Rapid</b>	200mm	240mm
<b>Semi-rapid</b>	160mm	180mm
<b>Auxiliary</b>	120mm	160mm

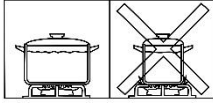
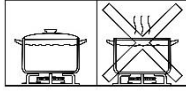
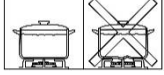
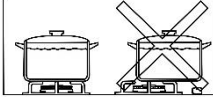
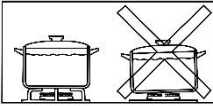
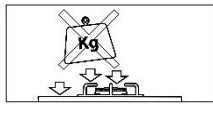
✓		X
Always use pans that are the right size for each burner to avoid wasting gas and discolouring the pans		Do not use small pans on large burners, the flame should never touch the sides of the pans
Place a lid on pans		Do not cook without a lid or with the lid half off, as this wastes energy
Only use pans with a thick, flat bottom.		Do not use damaged pans, which do not sit evenly on the hob: pans may tip over.
Always place pans centrally over the burners not to one side		Do not place pans on one side of a burner, as it could tip over
		Do not use large pans on burners near the controls, as they may be damaged by the high temperatures
Pans must always be put on the pan supports. Always ensure the pan supports and burner covers are correctly positioned before use		Never place pans directly on the burners
		Do not place anything between pan and pan support
Be careful when handling pans when they are on the burner or have just been taken away from the burner		Do not use excessive weight or strike the hob with heavy objects

# Usage

## Cooking recommendations:

The following advice is to help you get the best cooking performance/results:

Burner	Very high, High	Medium	Low
Rapid burner	Boiling, steaming, griddling, toasting, paellas, Escalopes, steaks, omelettes, frying.	Reheating and keeping things hot: cooked and pre-cooked dishes.	
		Rice, white sauce and ragout.	Steaming: fish, vegetables.
Semi-rapid burner	Steamed potatoes, fresh vegetables, stews, pasta, etc.	Reheating and keeping things hot: pre-cooked dishes and delicate casseroles.	
Auxiliary burner	Casseroles, rice pudding and caramels.	Defrosting and slow cooking: vegetables, fruits and frozen products.	Melting: butter, chocolate, gelatine

## Pan supports:

The pan supports will only align with the burners if they are put on the hob correctly. To ensure this is done the left pan support is marked with an L on the underside of the long flat side and the right pan support is marked with an R on the underside of the long flat side. The L on the left pan support has to be put on the left hand side of the hob and the R on the right pan support has to be put on the right hand side of the hob.

# Cleaning and Maintenance:

## Important notes:

- The appliance will become hot during operation, allow the appliance to cool down before cleaning.
- Do not use any high-pressure cleaners or steam cleaners.
- Wash new sponge cloths thoroughly before use.
- Follow all instructions and warnings included with the cleaning agents.

## How to clean

Observe the information in the table below to ensure that the different surfaces are not damaged by using the wrong type of cleaning agent. Do not use:

- Harsh or abrasive cleaning agents,
- Cleaning agents with a high concentration of alcohol,
- Hard scouring pads or sponges,
- High-pressure cleaners or steam cleaners.

Surface type	How to clean
Stainless Steel	Hot soapy water: Clean with a dish cloth and dry with a soft cloth.  Clean stainless steel surfaces in the direction of the grain only.  Special stainless steel cleaning products are available from specialist retailers. Apply a very thin layer of the cleaning product with a soft cloth.
Painted surfaces	Hot soapy water: Clean using a damp dish cloth and dry with a soft cloth/towel. Do not use any stainless steel cleaners.
Aluminium and plastic	Glass cleaner: Clean with a soft cloth.
Glass	Glass cleaner: Clean with a soft cloth. Do not use a glass scraper.

## Cleaning and Maintenance:

### How to clean:

- After each use, clean the surface of the respective burner parts once they have cooled down. If any residue is left (baked-on food, drops of grease etc.), however little, it will become stuck to the surface and more difficult to remove later. The holes and grooves must be clean for the flame to ignite properly.
- The movement of some pans may leave metal residue on the pan supports.
- Clean the burners and pan supports using soapy water and scrub with a non-wire brush.
- If the pan supports are fitted with rubber rests, ensure that these are also cleaned. The rests may come loose and the pan support may scratch the hob.
- Always dry the burners and pan supports completely.
- Water droplets or damp patches on the hob at the start of cooking may damage the enamel.
- After cleaning and drying the burners, make sure the burner covers are correctly placed on the diffuser.
- Always clean off any liquid as soon as it is spilt: you will save yourself any unnecessary effort.
- Do not leave acidic liquids (e.g. lemon juice, vinegar, etc.) on the hob.
- The ring cover of the double or triple flame burner and stainless steel parts such as hotplate rings, top sheet and the area around the burners may become discoloured over time. This is normal because of the high temperatures. Each time the appliance is used these parts should be cleaned with a product that is suitable for stainless steel.

**CAUTION:** The use of a gas cooking appliance results in the production of "heat, moisture and products of combustion" in the room in which it is installed. Ensure that the kitchen "is well ventilated especially when the **appliance is in use**": **keep natural ventilation holes open or install a mechanical ventilation device (mechanical extractor hood).**

# Cleaning and Maintenance:

## Cleaning the burners:

1. Remove the burner cover and spreader by pulling them upwards and away from the hob.
2. Soak them in hot soapy water.
3. Clean them before drying them carefully, ensuring that the flame holes are clean and completely dry.
4. Wipe the fixed parts of each burner with a damp cloth and dry them afterwards.
5. Gently wipe the ignition device and a damp cloth and dry them carefully, ensuring they are clean and completely dry.
6. Before placing the burners back on the hob you must ensure that the injector is not blocked.

Burner cover

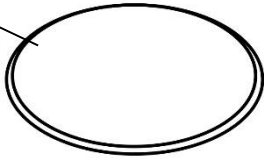

Flamer spreader

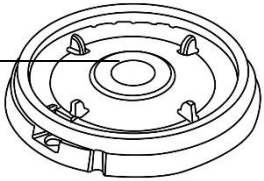

Burner cup

Ignition sparkers

Flame failure device

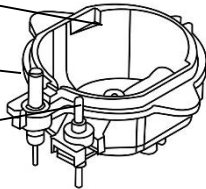

1. Place the flame spreader on to the burner cup so that the ignition device and the flame failure device extend through their respective holes in the flame spreader (the flame spreader must click into place correctly).
2. Position the burner cover onto the flame spreader so that the retaining pins fit into the their respective recesses.

 Russell Hobbs

## Trouble Shooting:

Problem	Solution	
Not ignited	The plug is not plugged in Connect the appliance to the electricity supply	
	Power cut or faulty fuse Check whether other kitchen appliances are working or check in the fuse box to make sure that the fuse for the appliance is working	
	The burner cover is badly assembled Assemble the burner cover correctly	
	The gas supply is closed Open the gas supply	
	Badly ignited	The burner cover is badly assembled Assemble the burner cover correctly
		The gas supply is closed Open the gas supply
The burners are wet Dry the burner cup, flame spreader and burner cover		
The holes in the burner spreader are clogged or the igniter is clogged Clean the burner spreader and igniter		

## Trouble Shooting:

Problem	Solution
Flame goes out when in use	The flame failure device is clogged
	Clean the flame failure device
	Food that is being cooked has boiled over and extinguished the flame
	Turn off the burner, wait for 1 minute and reignite the zone
	The burner cover is badly assembled
	Assemble the burner cover correctly
Excessive noise	Flame has been blown out by a strong draught
	Turn off the burner, check the cooking area for the source of the draught (open window, etc.). Stop the source of the draft, wait 1 minute and reignite the burner
	The burners make a noise during ignition and use
Unstable flame	This is normal
	The noise during operation is excessive
	The burner cup, flame spreader or burner cover may be badly assembled: Assemble correctly
Unstable flame	The burner cup, flame spreader or burner cover may be badly assembled
	Assemble correctly

## Trouble Shooting:

Problem	Solution
Yellow/orange flame	The holes in the burner spreader are clogged or the igniter is clogged  Clean the burner spreader and igniter
	Orange flame  This is caused by the presence of dust in the atmosphere, spilt liquids, etc.
	A different type of gas is being used  Check gas supply
	Gas smell
Vacate the area and contact customer services	

# Connection to the mains supply

**WARNING- THIS APPLIANCE MUST BE EARTHED**

This appliance is designed to operate from a mains supply of AC 220 - 240V ~ 50Hz. Check that the voltage marked on the product corresponds with your supply voltage.

For UK use only – Plug fitting details for rewirable plugs only (where applicable):  
As the colours of the wires in the mains lead of this appliance may not correspond with the coloured markings identifying the terminals in your plug, proceed as follows:

The GREEN/YELLOW wire is the EARTH and must be connected to the terminal which is marked with the letter E or by the earth symbol or coloured GREEN or GREEN/YELLOW.

The BLUE wire is the NEUTRAL and must be connected to the terminal marked with the letter N or coloured BLACK.

The BROWN wire is the LIVE wire and must be connected to the terminal marked with the letter L or coloured RED.

Always ensure that the plug cord grip is fastened correctly.

If a 13A (BS1363) fused plug is used it must be fitted with a 13amp fuse conforming to BS1362 and be BSI or ASTA approved.



**DANGER  
Electric  
Shock Risk**

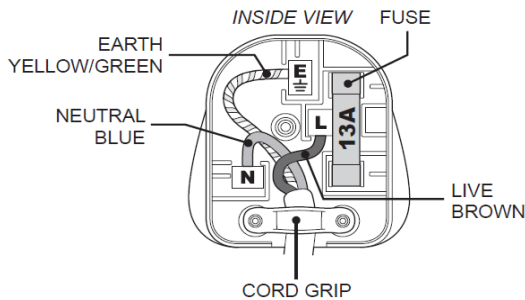

 **Russell Hobbs**

or visit us at <https://mda.russellhobbs.com>

## Guarantee

This product is guaranteed for 12 months from the date of the original purchase. If any defect arises due to faulty materials or workmanship you must contact Russell Hobbs with the original proof of purchase so a replacement or refund can be arranged.

Refund or replacement is at the discretion of Russell Hobbs.

### **The following conditions apply:**

- Russell Hobbs will require a valid proof of purchase at the point of replacement or refund.
- The product must be installed and used in accordance with the instructions contained in this instruction guide and any other instructions for use which has been supplied.
- It must be used for domestic purposes only and for its intended use.
- This guarantee does not cover wear and tear, damage, misuse or consumable parts.

**This does not affect your statutory rights.**

Imported by  
**G2S LIMITED**  
**WIGAN**  
**WN2 4AY**

 Russell Hobbs

# Technical Specification

Model number	<b>RH60GH402SS</b>
Rated Voltage	220V – 240V ~ 50Hz
External Dimensions(HxWxD)	95mm x 590mm x 510mm
Burner Power (KW)	Rapid burner - 3.0 (219g/h) Semi rapid burners – 1.75 (127g/h) Auxiliary burner - 1.0 (73g/h)
Gas hob class	Class 3
PIN	2531CT-0116

Gas type & Pressure	Electrical power	Heat input and orifice size marked(mm)				Total
		Rapid burner	Auxiliary rapid	Semi-rapid	Semi-rapid	
	<b>220-240Vac 50Hz</b>	3.0 (219g/h)	1.0kW (73g/h)	1.75 (127g/h)	1.75 (127g/h)	7.5kW (546g/h)
G30, 29mbar		0.85	0.5	0.65	0.65	
<b>G20, 20mbar</b> ✓		<b>1.30</b>	<b>0.72</b>	<b>0.97</b>	<b>0.97</b>	

Gas Category	I3+(28-30/37)		I2H ✓	I12H3+
Gas Type	G30	G31	G20	G20/(G30/G31)
Gas Pressure	28-30mbar	37mbar	20mbar	(20/(28-30/37)mbar
Country of Destination	GB			

 **Russell Hobbs**

## Notes

For Customer Services & Spare  
Parts please call **0345 208 8750**  
or visit us at  
**<https://mda.russellhobbs.com>**



This symbol is known as the 'Crossed-out wheeie bin Symbol'. When this symbol is marked on a product/batteries, it means that the product/batteries should not be disposed of with your general household waste. Only discard electrical/electronic/battery items in separate collection schemes, which cater for the recovery and recycling of materials contained within. Your co-operation is vital to make sure the success of these schemes and for the protection of the environment. For your nearest disposal facility, visit [www.recycle-more.co.uk](http://www.recycle-more.co.uk) or ask in store for details.

We reserve the right due to possible changes to design to alter the instruction manual without prior notice.

 **Russell Hobbs**

Revision 7