

This Owner's Manual is provided and hosted by [Appliance Factory Parts](#).



Russell Hobbs RHCV3601 Owner's Manual

[Shop genuine replacement parts for Russell Hobbs
RHCV3601](#)



[Find Your Russell Hobbs Vacuum Cleaner Parts - Select From 14 Models](#)

----- Manual continues below -----



Russell Hobbs

NEPTUNE 11 in 1 Steam Mop

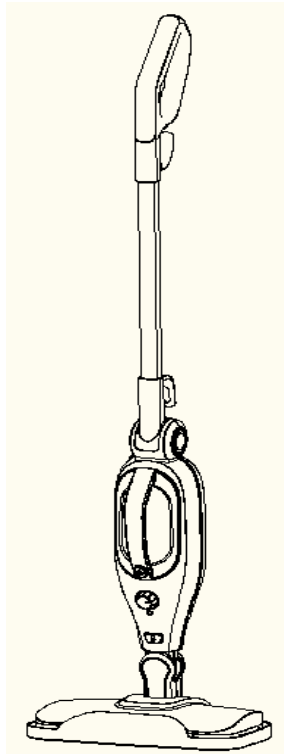

Model Number: RHMSM3101

For Customer Services & Spare Parts please call **0345 209 7461**
Opening times: Monday - Friday 8am – 8pm & Saturday 9am – 1pm
Or visit us at www.productcare.co.uk

PLEASE RETAIN
FOR FUTURE REFERENCE

CONTENTS

	Page(s)
Safety instructions	3-6
Steam mop feature diagram	7
Steam mop assembly	8-9
Filling the water tank	10
Using your steam mop	11-12
Storing your steam mop	13
Cleaning and care	14-16
Problem solving	17-18
Guarantee and customer services	19
Connection to the mains supply	20-21
Notes	22-23
Disposal information	24

Thank you for purchasing your Russell Hobbs Neptune Steam Mop.

To get the best from your new mop, take a few moments to read these instructions, and keep them in a safe place for future reference.

Should you require any further assistance, our friendly Product Care team will be happy to help.

For Customer Services & Spare Parts please call **0345 209 7461**
Opening times: Monday - Friday 8am – 8pm & Saturday 9am – 1pm
Or visit us at **www.productcare.co.uk**

SAFETY INSTRUCTIONS

IMPORTANT SAFETY INSTRUCTIONS **READ CAREFULLY AND KEEP FOR FUTURE REFERENCE**

WARNING:

- It is hazardous for anyone other than a competent person to carry out any service or repair operation that involves the removal of a cover which gives protection against exposure to electrical parts.
- If the supply cord is damaged, it must be replaced by the manufacturer, its service agent or similarly qualified persons in order to avoid a hazard.
- This product is intended for household use only. Do not use outdoors.
- This appliance can be used by children aged from 8 years and above and persons with reduced physical, sensory or mental capabilities or lack of experience and knowledge IF they have been given supervision or instruction concerning use of the appliance in a safe way and understand the hazards involved. Children shall not play with the appliance. Cleaning and user maintenance shall not be made by children unless they are older than 8 and supervised. Keep the appliance and its' cord out of reach of children less than 8 years.
- Do not operate this appliance for anything other than its intended use. This product is intended for household use only. Do not use outdoors.
- Do not immerse in water or other liquids for cleaning.

SAFETY INSTRUCTIONS

IMPORTANT SAFETY INSTRUCTIONS **READ CAREFULLY AND KEEP FOR FUTURE REFERENCE**

WARNING:

- Do not direct steam at people, animals, electrical outlets, or equipment containing electrical components.
- Unplug from power outlet when not in use. Do not leave steam mop unattended while plugged in.
- Do not use with damaged cord or plug.
- Do not use steam mop if it has been dropped, damaged, left outdoors or dropped into water.
- Keep the steam mop away from water; do not allow it to get wet. If unit is wet, do not plug unit into wall socket or turn unit on.
- Do not handle steam mop with wet hands.
- Do not pull or carry by cord, use cord as a handle, close door on cord, pull cord around sharp corners or edges, or expose cord to heated surfaces.
- Do not unplug by pulling on cord.
- To protect against electrical shock do not immerse cord, plug, or appliance in water or other liquid.
- Unplug from the mains outlet when not in use, before putting on and taking off parts, and before cleaning.

SAFETY INSTRUCTIONS

IMPORTANT SAFETY INSTRUCTIONS **READ CAREFULLY AND KEEP FOR FUTURE REFERENCE**

WARNING:

- The use of accessory attachments not recommended by the appliance manufacturer may cause fire, electric shock or injury. Only use the accessories supplied by the manufacturer.
- Do not let the cord hang over the edge of the worktop, or touch hot surfaces.
- Never remove parts from the appliance such as the screws and so on.
- The filling aperture must not be opened during use.
- Do not use appliance in an enclosed space filled with vapor given off by oil-based paint, paint thinner, some moth proofing substances, flammable dust, or other explosive or toxic vapors.
- Do not use on leather, wax polished furniture or floors, synthetic fabrics, velvet or other delicate, steam-sensitive materials.
- Do not immerse unit in water or other liquids.
- Never put descaling, aromatic or alcoholic products into the steam mop, as this may damage the unit. Descal the product regularly with a mixture of 50% natural white vinegar & 50% water to maintain its performance, and allow the mixture to steam through the product.

SAFETY INSTRUCTIONS

IMPORTANT SAFETY INSTRUCTIONS **READ CAREFULLY AND KEEP FOR FUTURE REFERENCE**

WARNING:

- Close attention is necessary when used near children.
- Do not store with a wet mop pad still attached.
- Using distilled or demineralized water will maximize the performance of your steam mop.
- Use extra care when cleaning on stairs.
- Do not use steam for space heating purposes; household use only.
- Use on waxed or some unwaxed floors may diminish glossiness. Do not use on unsealed wood floors. Test in an inconspicuous area or check the care instructions from your flooring manufacturer.
- Quality testing during the manufacturing process may result in water droplets remaining within the water tank.
- If you shake this product the water cut-off valve will make a rattling noise. This is normal and is not a defect.

Symbol IEC 60417-5597 (2002-10) is used on the unit to indicate that this unit operates with hot water vapour (steam). To avoid scalding and burns take extra care when in use.



For Customer Services & Spare Parts please call **0345 209 7461**
Opening times: Monday - Friday 8am – 8pm & Saturday 9am – 1pm
Or visit us at **www.productcare.co.uk**

STEAM MOP FEATURE DIAGRAM

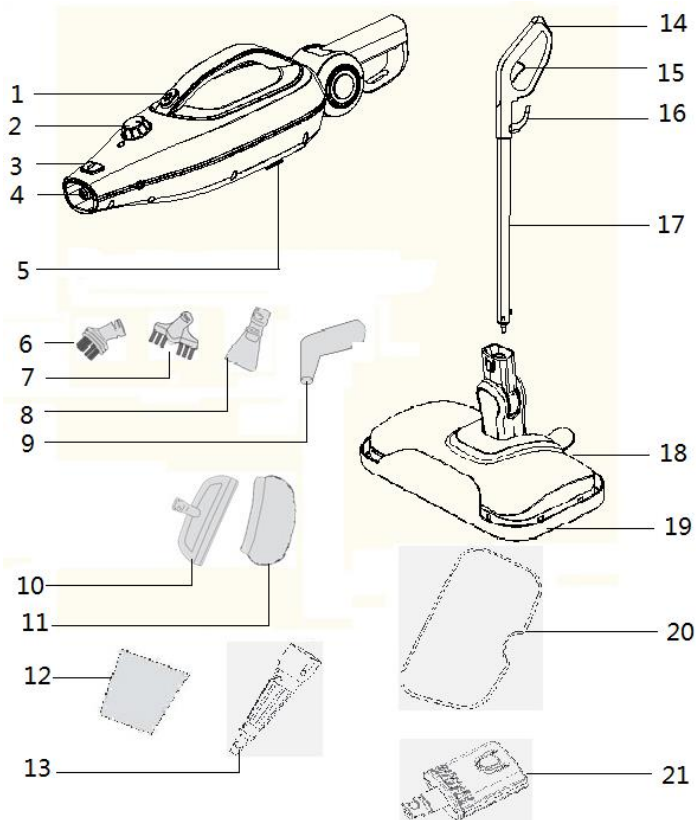

1 Steam Button	9 Detail Nozzle	17 Aluminium Handle
2 Steam Adjust Dial	10 Window/ Upholstery Tool	18 Floorhead
3 Release Button	11 Upholstery Pad	19 Carpet Glider
4 Steam Outlet	12 Filling Jug	20 Microfibre Pad
5 Hard Water Filter	13 Jet Nozzle	21 Accessory Joint
6 Small Brush	14 Handle	
7 Grout Brush	15 Trigger	
8 Scraper Tool	16 Cord Hook	

For Customer Services & Spare Parts please call **0345 209 7461**
 Opening times: Monday - Friday 8am – 8pm & Saturday 9am – 1pm
 Or visit us at www.productcare.co.uk

STEAM MOP ASSEMBLY

Before using your steam mop:

Remove all packaging and lay out the separate components.

Check the steam mop after unpacking for any visual damage such as:

- Misaligned or damaged parts
- Damage to the main body and separate components
- Damage to the plug or cable.

If you can see any damage do not use the steam mop and refer page 19.

Handle assembly

Note: Before assembling/disassembling any parts of the product make sure the unit is unplugged and has cooled sufficiently.

The handle comes in 2 parts:

- Handle top
- Handle tube

1. Fit the handle top onto the handle tube, applying a small amount of pressure until you hear it 'click' into place.

2. Once this is secure, put the assembly into the top of the main unit with the cord hook parallel to the back of the unit. Push the tab on the base to allow the handle to fully insert and secure. This should 'click' into place.

3. If you wish to remove the handle, simply push the release button on the back of the unit and lift the assembly upwards. The release button on the handle top allows you to disassemble the handle parts if required.

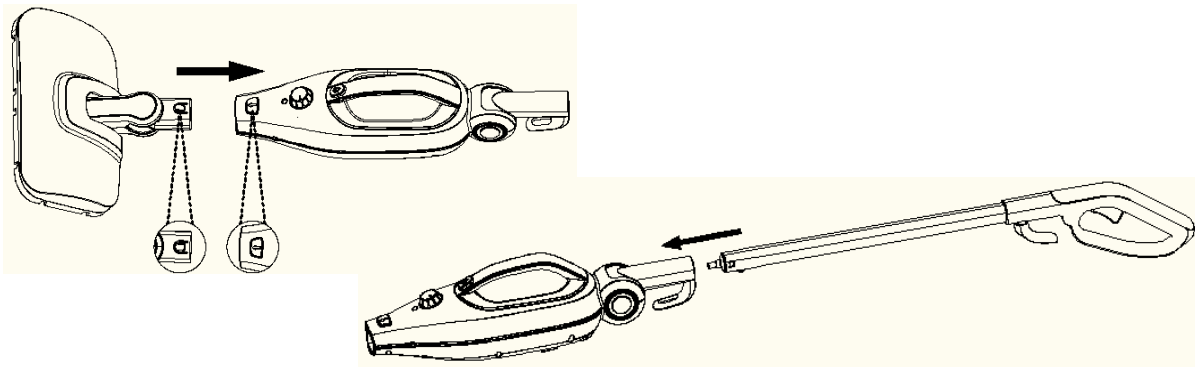

STEAM MOP ASSEMBLY

Microfibre mop pad attachment

The steam mop should never be operated without the mop pad attached.

To attach the pad, place it on the floor with the velcro facing upwards and removal lip to the back. Lift the mop above the pad and align the head with the mop pad. Lower the pad and rest the mop on it to secure the velcro to the head.

To remove the pad, secure your foot on the protruding piece of cloth and lift the mop away.

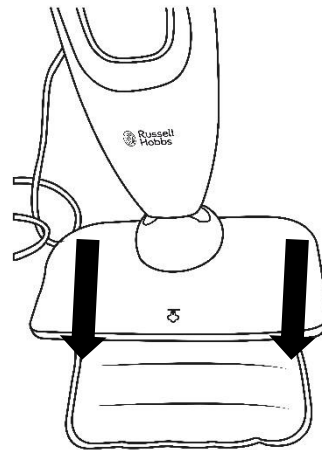

Carpet glider attachment

The mop can be used with the carpet glider attachment to refresh carpets and rugs.

To attach the carpet glider, lift the mop over the glider and lower the front of the mop head under the two plastic ribs. Next, lower the back end of the head. This should secure the head in place.

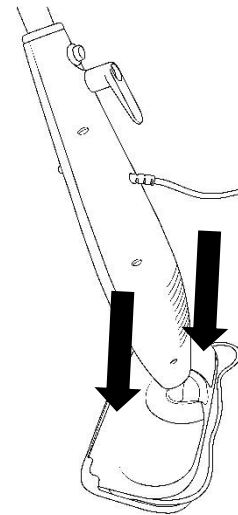

To remove the glider, place your foot on the protruding plastic and lift the mop upwards.

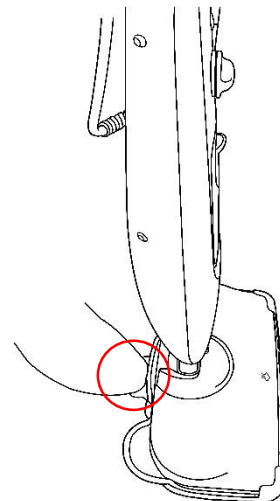

FILLING THE WATER TANK

Note: Before filling/re-filling the water tank, unplug the steam mop. Do not touch any hot parts before allowing them to cool sufficiently.

1. Lay the steam mop horizontally.
2. Pull open the cap on the water tank.
3. Fill the provided measuring jug with water, being careful not to spill any liquid.

Note: It is recommended to use treated water in your steam mop, especially in hard water areas. Water can be treated using water filters. Using untreated hard water can reduce the performance and life span of your product. Never use boiled water in your steam appliance. This is harmful as the boiled water that has not turned to steam contains solely the hard water minerals that should be avoided.

4. Use the jug to fill the tank to the 'MAX' fill line.
5. Close the cap on the tank so that it is secure. Lift the mop upright.

A full tank should provide approximately 15 minutes steam time. The mop will not steam if you do not turn on the power and wait sufficient time for the water to heat.

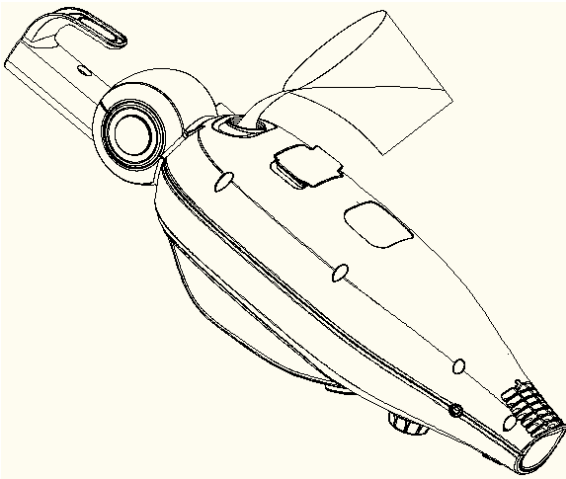

NOTE: The tube which transfers water from the Water Tank to the boiler is weighted down with a brass ball. This is an intentional design to improve efficiency of water usage. It is normal for this ball to create a rattling sound inside of Water Tank during use.

IF you think brass ball has come loose from tube, refer to Troubleshooting Guide for directions to reconnect it.

USING YOUR STEAM MOP

Preparing for use

After all required parts are assembled, make sure your floors are vacuumed/swept before using the steam mop.

Using

1. Pull and twist the cord release, plug the steam mop into a mains socket and switch the power on.
2. Make sure the water tank is filled, following instructions on page 10.
3. Turn the steamdial clockwise from the 'OFF' to the 'ON' position.
4. The power light should be illuminated red. Wait approximately 30 seconds for the water to heat sufficiently and the steam mop is ready to use.
5. Tilt the steam mop backwards, approximately 45°, depress the trigger, and it will begin to steam. When trigger is released the steam will automatically stop. Switch off when not in use.
6. Move the steam mop forwards and backwards over the areas you wish to steam clean.

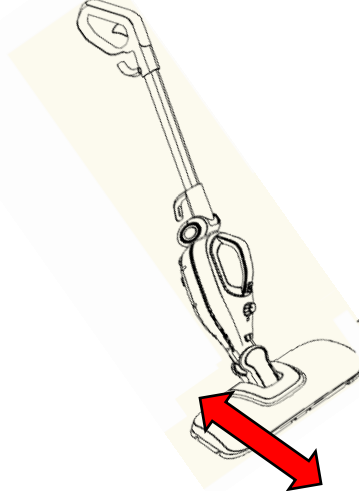
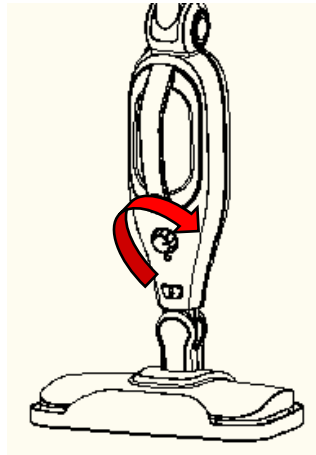
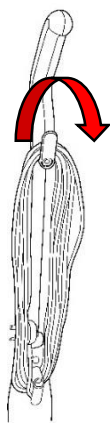

Note: When using the steam mop, do not leave it over a particular area for more than 30 seconds. This could cause damage.

If the steam flow slows down or stops the unit may need refilling with water.

To refill the water tank: unplug the unit and allow to cool, then follow instructions on page 10.

USING YOUR STEAM MOP

Using the Multi Functions

Your Neptune steam mop comes supplied with attachments for at least 11 different uses such as handheld cleaning, grout, and windows.. To change between attachments, you must use the provided connecting joint.

Firstly, disconnect the floorhead by pressing the button on the front of the machine. Insert the attachment tool, and then attach the desired function tool by twisting onto the end.

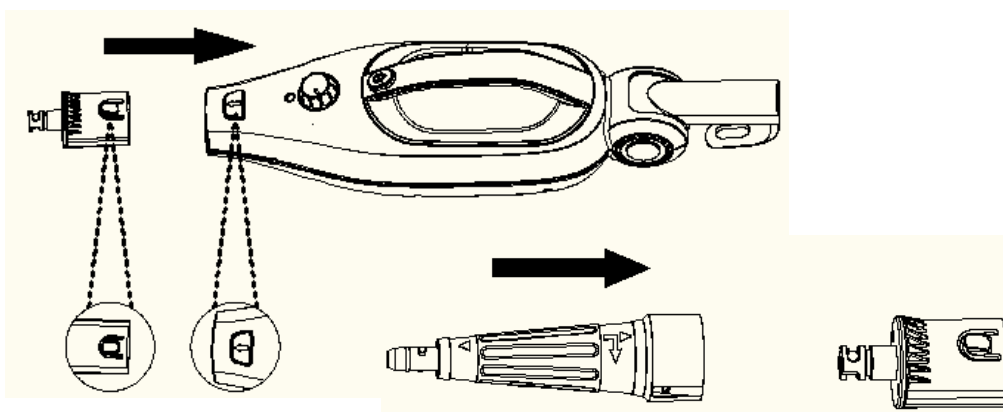

SAFETY WARNING

DO NOT aim steam at any person, animal, or on any part of your body.

For grout, use the attached brush to scrub grime.

Only use the attachments on suitable surfaces, the coarse brushes may cause damage to stainless steel appliances if used incorrectly.

Do not use on any one location for more than 30 seconds as this may cause irreparable damage.

STORING YOUR STEAM MOP

After use

1. When you require a break or have finished steam cleaning, tilt the steam mop forwards so that it is stood vertical. This will stop the unit from steaming.
2. Turn the steam dial to the 'off' position.
3. Switch the power off at the plug socket and remove the plug.
4. Allow the mop pad to fully cool and then carefully remove from the mop head.

Note: Do not install or remove the mop pad while steam is emitting.

5. Empty any remaining water from the water tank before storing.
6. Wrap the power cord around the upper and lower cord hooks.

Store upright in a protected, dry area.

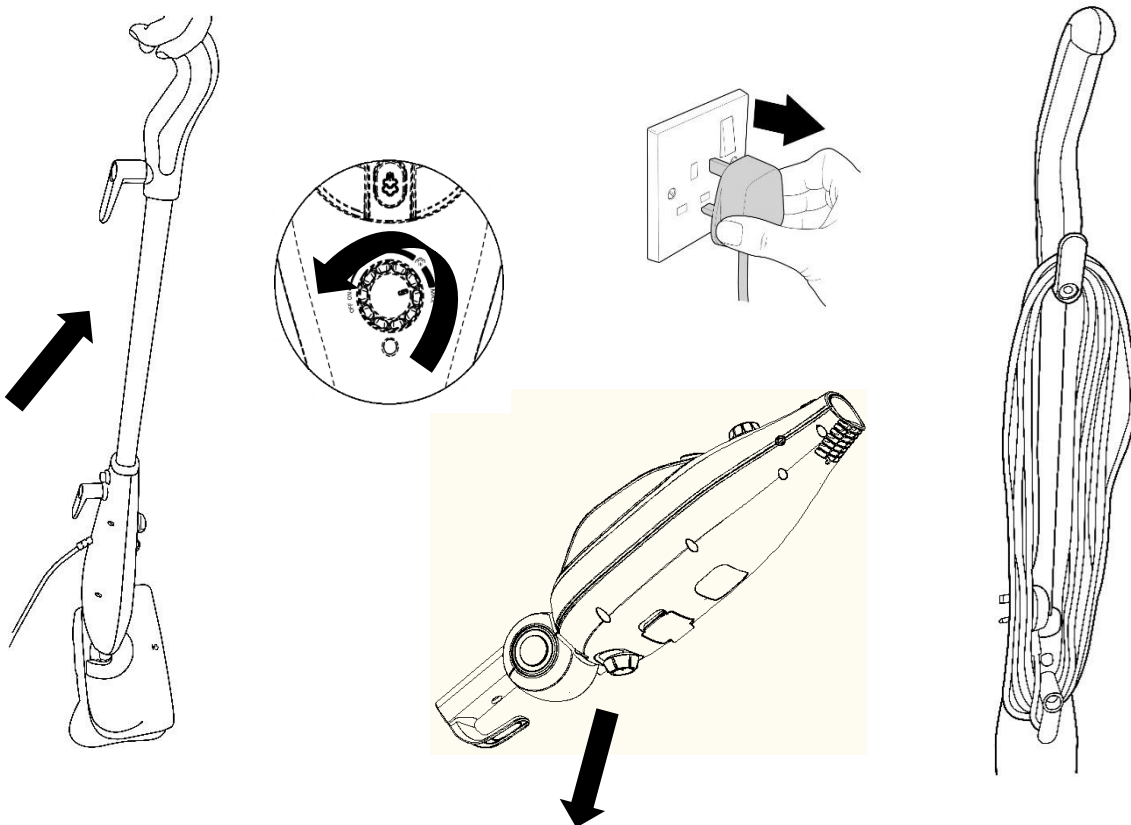

CLEANING AND CARE

Before you clean the appliance, disconnect the mains plug from the wall socket.

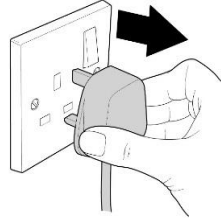

To clean the exterior of the device, use a damp, soft cloth and mild detergent.

NEVER IMMERSER THE STEAM MOP IN WATER.

When wiping off the main body, do not allow moisture in the area around the indicator light.

Wash non-electrical accessories in warm soapy water and allow to dry thoroughly before next use.

If the steam mop is damaged, contact the customer service helpline using the details at the bottom of this page.

Care of your microfibre cleaning pads

Wash pads in warm water, no more than 40 degrees.

Wash separately. Do not use fabric softener and do not tumble dry.

Dry on a line.

Should there be any loose threads on the microfibre pad, carefully cut the threads with scissors.

Do not try to pull any threads or cut any threads at the base.

For Customer Services & Spare Parts please call **0345 209 7461**
Opening times: Monday - Friday 8am – 8pm & Saturday 9am – 1pm
Or visit us at **www.productcare.co.uk**

CLEANING AND CARE

Changing the Hard Water Filter

Your Neptune steam mop has been provided with a Hard Water Filter that will need periodically changing. These can be ordered from www.productcare.co.uk, and it is recommended only to use genuine manufacturer supplied parts.

If replacing after use, turn off, unplug and wait 5 minutes for the unit to cool before attempting to replace. Press the clips to both sides and remove the filter from the unit. Replace with a new genuine filter by pushing back into the slot.

SAFETY WARNING

DO NOT attempt to replace whilst unit is on or still hot, this could cause serious injury and harm.

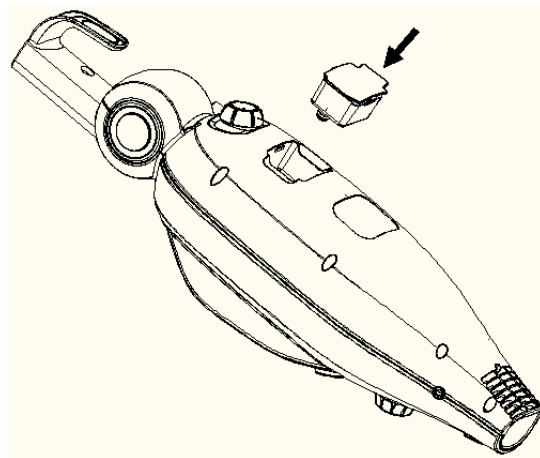

For Customer Services & Spare Parts please call **0345 209 7461**
Opening times: Monday - Friday 8am – 8pm & Saturday 9am – 1pm
Or visit us at www.productcare.co.uk

CLEANING AND CARE

Removing Mineral Build Up

In hard water areas, mineral build up and limescale may limit the performance of your Neptune Steam Mop.

The best way to minimize mineral build-up is to use distilled or de-mineralized water when using your *Neptune Steam Mop*. In addition, it is recommended that the cleaning procedure below be followed at least once a month in order to remove any deposits. This will help to extend the life of your *Neptune Steam Mop* and keep it functioning at its maximum potential. Unplug your Neptune Steam Mop and wait 5 minutes for it to cool. Remove all accessories, then remove the water tank cap and drain into a sink. Insert tip of Cleaning Pin into opening of Steam Nozzle to remove mineral build-up in nozzle. This may also be done to clean accessories such as the Jet Nozzle. Use Measuring Cup to make a mixture of approximately 100mL. distilled water and 50mL. vinegar.

Slowly pour water-vinegar solution into the water tank, then replace Water Tank Cap.

Plug in the power cord, set Steam Control Dial to HIGH, and spray full contents of Water Tank into a sink or tub.

Once Water Tank is drained, turn the unit off and refill Tank with 350ml. of fresh distilled water. Set Steam Control Dial back to HIGH and repeat. If you used a water-vinegar solution, you may need to repeat this until vinegar odor dissipates.

Replace Water Tank Cap, unplug power cord, and store *Neptune Steam Mop* as usual.

SAFETY WARNING

TAKE CARE not to come in contact with any water whilst descaling as this may cause injury or harm.

For Customer Services & Spare Parts please call **0345 209 7461**
Opening times: Monday - Friday 8am – 8pm & Saturday 9am – 1pm
Or visit us at **www.productcare.co.uk**

PROBLEM SOLVING

<u>PROBLEM</u>	<u>POSSIBLE PROBLEM</u>	<u>POSSIBLE SOLUTION</u>
<i>Reduced steam/no steam is coming out</i>	1. Water tank may not be filled.	1. Make sure the water tank is filled. Refer to page 10 of the instruction manual provided.
	2. The unit may not be plugged in properly/the fuse or breaker may not be working.	2. Verify the unit is plugged into an approved electrical outlet and that the fuse or breaker is functioning properly. Ensure you have waited at least 30 seconds for the water to heat up.
	3. Power dial is not turned to 'on'.	3. Ensure the power dial is turned to the 'ON' position.
<i>The indicator light is not working</i>	1. The unit may not be plugged in properly/the fuse or breaker may not be working.	1. Verify the unit is plugged securely into an approved electrical outlet and that the fuse or breaker is functioning properly. Ensure the power dial is switched to 'ON'.
<i>There is a peculiar smell coming from the unit</i>	1. First time using product.	1. If this is the first time you are using the mop, continue using the product. The smell may be due to new parts being heated up for the first time.
	2. This is not the first time the product has been used.	2. Discontinue use if problem persists and contact Customer Services using the details on the next page.
<i>There is a 'clicking/bubbling/rattle' noise coming from the steam mop when in use</i>		1. This is a normal occurrence due to the construction of the product and its operational functionality.
<i>There is a puddle of water/the mop pad is not picking up dirt</i>	1. The mop pad is saturated and needs changing.	1. Wash the mop pad, following cleaning and care instructions provided on page 13 of the manual.
<i>Parts have broken/need replacing</i>	1. Either the mop pad, carpet glider, measuring jug or handle have broken or been lost.	1. Call customer services or visit the website detailed at the bottom of the next page.
	2. None of the above have broken but another part has.	2. Discontinue use and contact customer services using the details on the bottom of the next page.

PROBLEM SOLVING

<u>PROBLEM</u>	<u>POSSIBLE PROBLEM</u>	<u>POSSIBLE SOLUTION</u>
<i>I have lost the instruction manual provided</i>	1. The instruction manual has been lost or misplaced.	1. It is important to have a copy of the instruction manual. Visit www.productcare.co.uk or contact customer services using the details provided on the bottom of this page.
<i>The brass ball has disconnected from the water tank</i>	The connection has come loose and come away from the tank	Simply reattach it by snapping it back onto black nozzle at end of tube.

We're here should you need us.

For Customer Services & Spare Parts please call 0345 209 7461

Opening times: Monday - Friday 8am – 8pm & Saturday 9am – 1pm

Or visit us at www.productcare.co.uk

GUARANTEE AND CUSTOMER SERVICES

At Russell Hobbs, we take all our customer feedback seriously.

Feel free to contact our Product Care Team, on 0345 209 7461

Monday – Friday: 8am-8pm & Saturday: 9am – 1pm,

who will be more than happy to assist you.

This product is guaranteed for **12 months** from the date of the original purchase. If any defect arises due to faulty materials or workmanship, the faulty product must be returned to the place of purchase.

Refund or replacement is at the discretion of the retailer.

The following conditions apply:

- The product must be returned to the retailer with the original proof of purchase.
- The product must be installed and used in accordance with the instructions contained in this instruction guide and any other instructions for use which are supplied.
- It must be used for domestic purposes only and for its intended use.
- This warranty does not cover wear and tear, damage, misuse or consumable parts.

This does not affect your statutory rights.

For Customer Services & Spare Parts please call **0345 209 7461**
Opening times: Monday - Friday 8am – 8pm & Saturday 9am – 1pm
Or visit us at **www.productcare.co.uk**

CONNECTION TO THE MAINS SUPPLY

WARNING- THIS APPLIANCE MUST BE EARTHED

This appliance is designed to operate from a mains supply of
220-240V~ 50Hz.

Check that the voltage marked on the product corresponds
with your supply voltage.

This product is fitted with a 13A plug complying with BS1363.
If this plug is unsuitable or needs to be replaced, refer to customer
services.

Important: The wires in the mains lead are coloured in
accordance with the following code:

GREEN/YELLOW – EARTH

BLUE - NEUTRAL

BROWN – LIVE

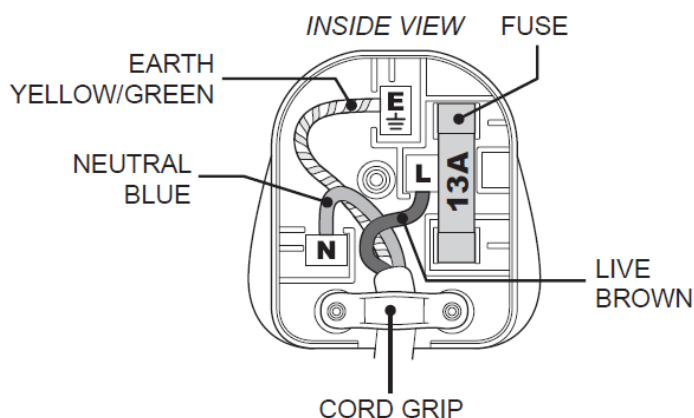

CONNECTION TO THE MAINS SUPPLY

For UK use only – PLUG

- As the colours of the wires in the mains lead of this appliance may not correspond with the coloured markings identifying the terminals in your plug, proceed as follows:
- The **GREEN/YELLOW** wire is the EARTH and must be connected to the terminal which is marked with the letter E or by the earth symbol or coloured **GREEN** or **GREEN/YELLOW**.
- The **BLUE** wire is the NEUTRAL and must be connected to
- the terminal marked with the letter N or coloured **BLACK**.
- The **BROWN** wire is the LIVE wire and must be connected to
- the terminal marked with the letter L or coloured **RED**.
- **Always ensure that the plug cord grip is fastened correctly.**
- If a 13A (BS1363) fused plug is used it must be fitted with a
- 13amp fuse conforming to BS1362 and be BSI or ASTA approved.

If the fuse cover is lost the plug must not be used until a replacement is obtained from an electrical supplier.

If you need to remove the plug, cut it from the mains lead and dispose of it. NEVER attempt to re-use this plug or insert it into a socket outlet, as there is a very great risk of electrical shock.

Notes

A large, empty rounded rectangular box with a thin green border, intended for taking notes.

Notes

A large, empty rounded rectangular box with a thin green border, intended for taking notes.



Russell Hobbs

For Customer Services & Spare
Parts please call

0345 209 7461

Opening times: Monday - Friday
8am – 8pm & Saturday 9am – 1pm

Or visit us at

www.productcare.co.uk

Revision 1.7

Model: RHMSM3101

Produced for G2S Ltd,
Wigan,
WN2 4AY

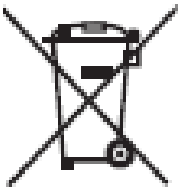

This symbol is known as the 'Crossed-out wheellie bin Symbol'. When this symbol is marked on a product/batteries, it means that the product/batteries should not be disposed of with your general household waste. Only discard electrical/electronic/battery items in separate collection schemes, which cater for the recovery and recycling of materials contained within. Your co-operation is vital to ensure the success of these schemes and for the protection of the environment. For your nearest disposal facility, visit www.recycle-more.co.uk or ask in store for details.

We reserve the right, due to possible changes to design, to alter the instruction manual without prior notice.