

This Owner's Manual is provided and hosted by [Appliance Factory Parts](#).



Russell Hobbs RHCV4601 Owner's Manual

[Shop genuine replacement parts for Russell Hobbs
RHCV4601](#)



[Find Your Russell Hobbs Vacuum Cleaner Parts - Select From 14 Models](#)

----- Manual continues below -----



Russell Hobbs

Operating Manual

TITAN²

RHCV4101/RHCV4601

ASSEMBLY

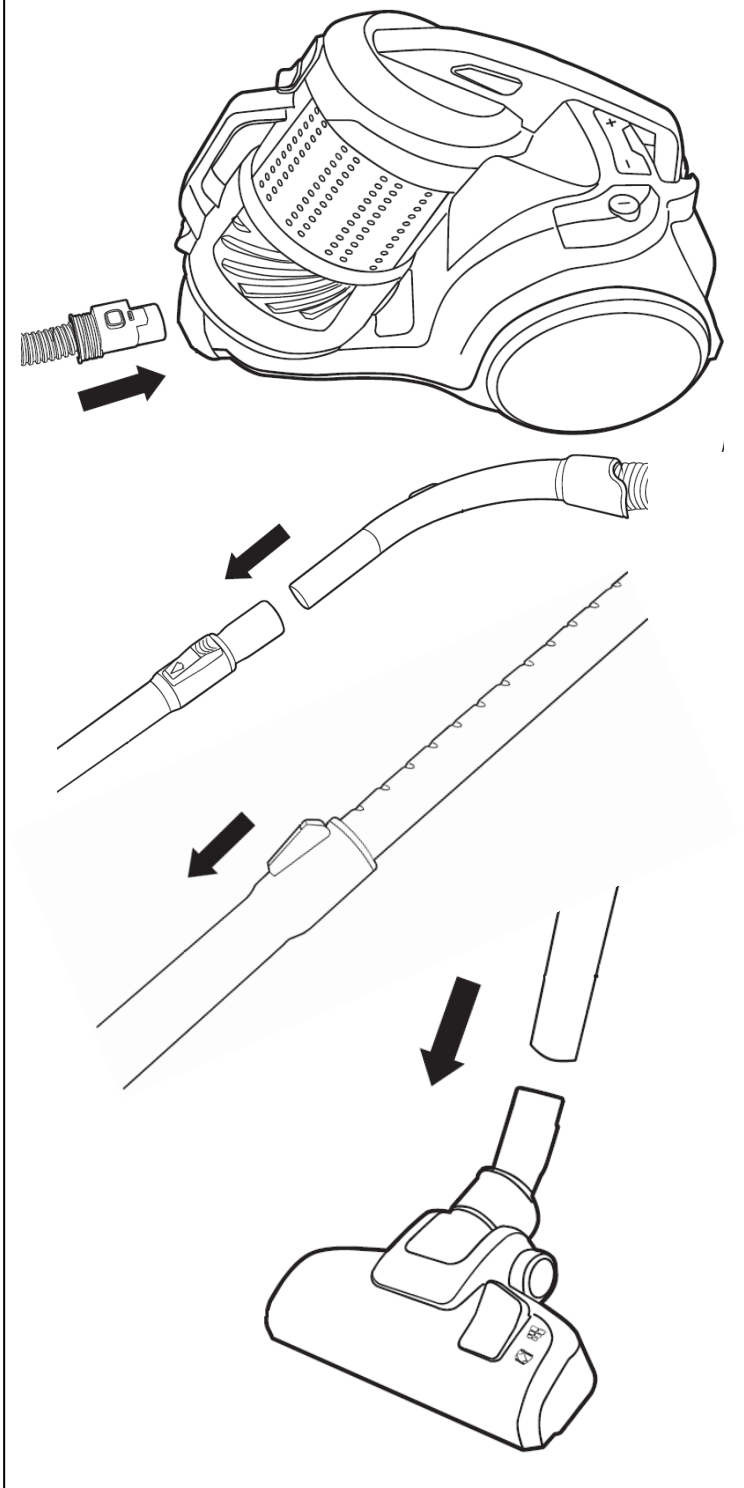

POWERING ON

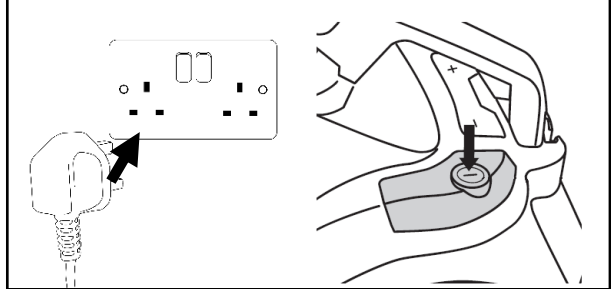

SUITABLE FOR USE

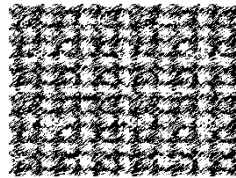

Carpet

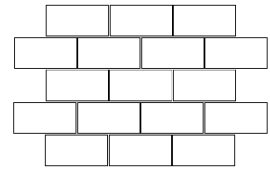

Hard Floors

WASH FILTERS

Wash the filters with cold water at least once a month

1

MONTH

REGISTER YOUR FREE 1 YEAR GUARANTEE TODAY

GUARANTEE

At Russell Hobbs, we take all our customer feedback seriously.

Feel free to contact our Product Care Team, on **0345 209 7461** who will be more than happy to assist you.

This product is guaranteed for 12 months from the date of the original purchase. If any defect arises due to faulty materials or workmanship, the faulty product must be returned to the place of purchase.

Refund or replacement is at the discretion of the retailer.

The following conditions apply:

- The product must be returned to the retailer with the original proof of purchase.
- The product must be installed and used in accordance with the instructions contained in this instruction guide and any other instructions for use which are supplied.
- It must be used for domestic purposes only and for its intended use.
- This guarantee does not cover wear and tear, damage, misuse or consumable parts.
- This does not affect your statutory rights.

RUSSELL HOBBS CONTACT DETAILS

Website: <https://mda.russellhobbs.com>

Telephone: 0345 209 7461

Address: Product Care Customer Service, Green Bank Business Park, Hindley Green, Wigan, WN2 4AY

Note your serial number below for future reference.



Image for illustration purposes only

REGISTER ONLINE

Visit our website to register your full parts and labour guarantee online.

<https://mda.russellhobbs.com>

REGISTER BY PHONE

Call our friendly Product Care team.

0345 209 7461

IMPORTANT SAFETY INSTRUCTIONS

- It is hazardous for anyone other than a competent person to carry out any service or repair operation that involves the removal of a cover which gives protection against exposure to electrical parts.
- If the supply cord is damaged, it must be replaced by the manufacturer, its service agent or similarly qualified persons in order to avoid a hazard.
- This product is intended for household use only.
- Do not use outdoors.
- This appliance can be used by children aged from 8 years and above and persons with reduced physical, sensory or mental capabilities or lack of experience and knowledge if they have been given supervision or instruction concerning use of the appliance in a safe way and understand the hazards involved. Children should not play with the appliance. Cleaning and user maintenance should not be made by children without supervision.
- Do not operate this appliance for anything other than its intended use.
- Do not immerse in water or other liquids for cleaning.
- Do not direct at people, animals, electrical outlets, or equipment containing electrical components.
- Unplug from outlet when not in use. Do not leave the cleaner unattended while plugged in.
- Do not use with damaged cord or plug.
- Do not use vacuum cleaner if it has been dropped, damaged, left outdoors or dropped into water.
- Keep the vacuum cleaner away from water; do not allow it to get wet. If unit is wet, do not plug unit into wall socket or turn unit on.
- Do not handle the vacuum cleaner with wet hands.
- Do not pull or carry by cord, use cord as a handle, close door on cord, pull cord around sharp corners or edges, or expose cord to heated surfaces.
- Do not unplug by pulling on cord.
- To protect against electrical shock do not immerse cord, plug, or appliance in water or other liquid.
- Unplug from the mains outlet when not in use, before putting on and taking off parts, and before cleaning.
- The use of accessory attachments not recommended by the appliance manufacturer may cause fire, electric shock or injury. Only use the accessories supplied by the manufacturer.
- Do not let the cord hang over the edge of the worktop, or touch hot surfaces.
- This cleaner is intended for internal household use only, do not use outside or for anything other than its' intended purpose.
- Do not use this vacuum to pick up water or any other liquids, combustible substances or hot/burning objects.
- Only use the unit when fully assembled.
- Never place your fingers or other objects into any part of the cleaner. Be aware that loose clothing or hair may become trapped in the cleaner if improperly used.
- Before use, ensure that all of the air vents of the cleaner are clear and there is no restriction of air flow.
- Caution: Exhaust air discharged from the sides of the cleaner may extinguish a gas fire, pilot light, or disturb ashes in an open fire. Always avoid directing the cleaner toward naked flames.
- Do not run the vacuum cleaner over any cables, or its own power cable. As this will result in damaging the cable.
- Important: This cleaner has a thermal safety device which automatically cuts off the power supply in case of overheating. If the safety device has switched the cleaner off, unplug from the mains and allow the cleaner to cool down. Once the cleaner has cooled it can be plugged back in to the mains and used as normal. This takes approximately 15 minutes to reset.

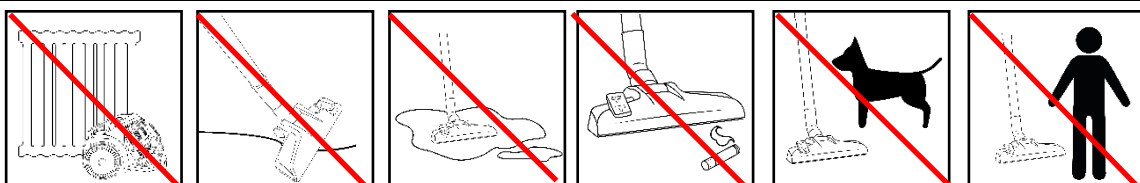

OPERATION

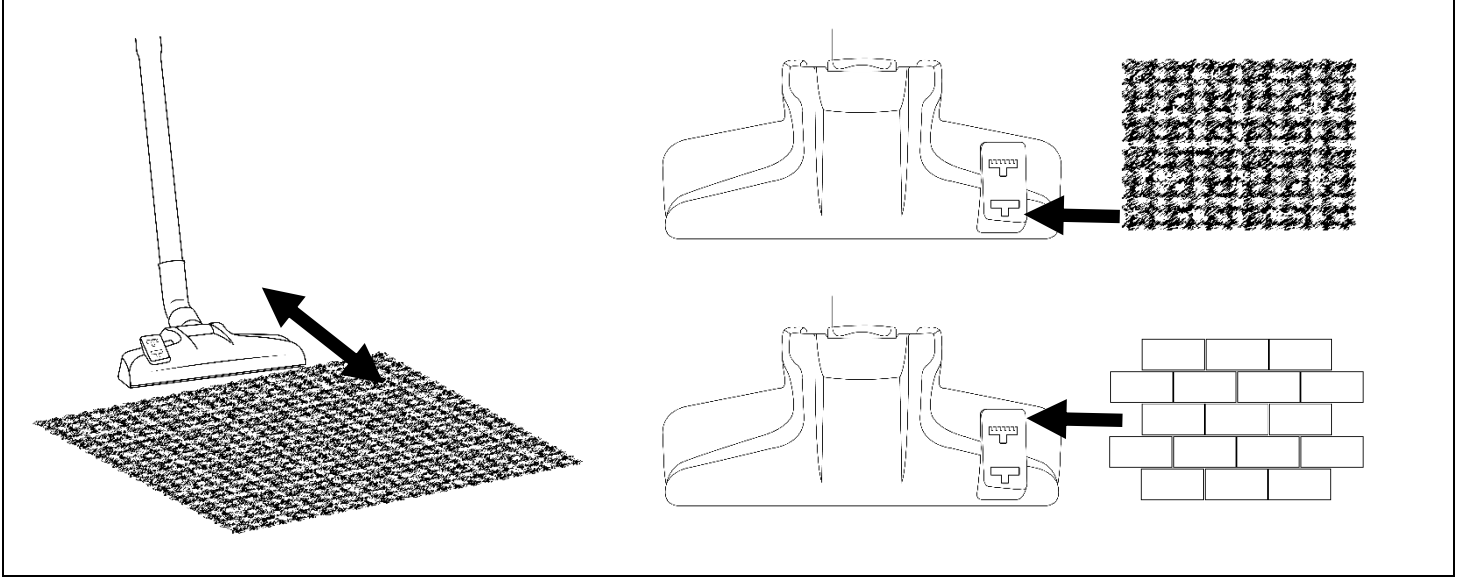

CARRYING THE APPLIANCE



TOOL ATTACHMENTS

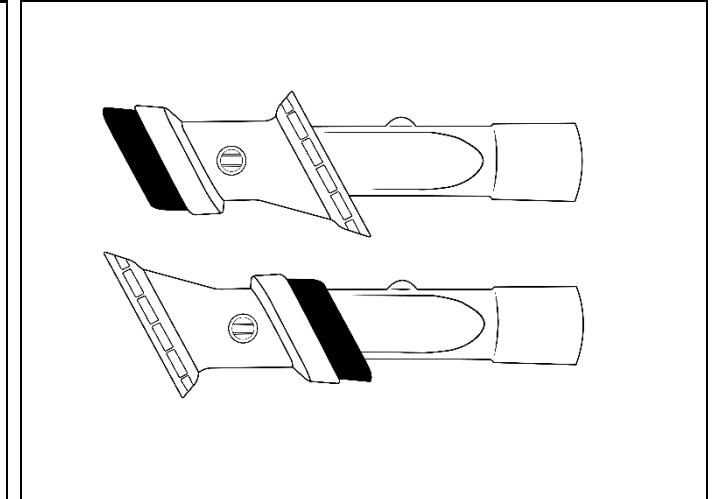

TOOL ATTACHMENTS

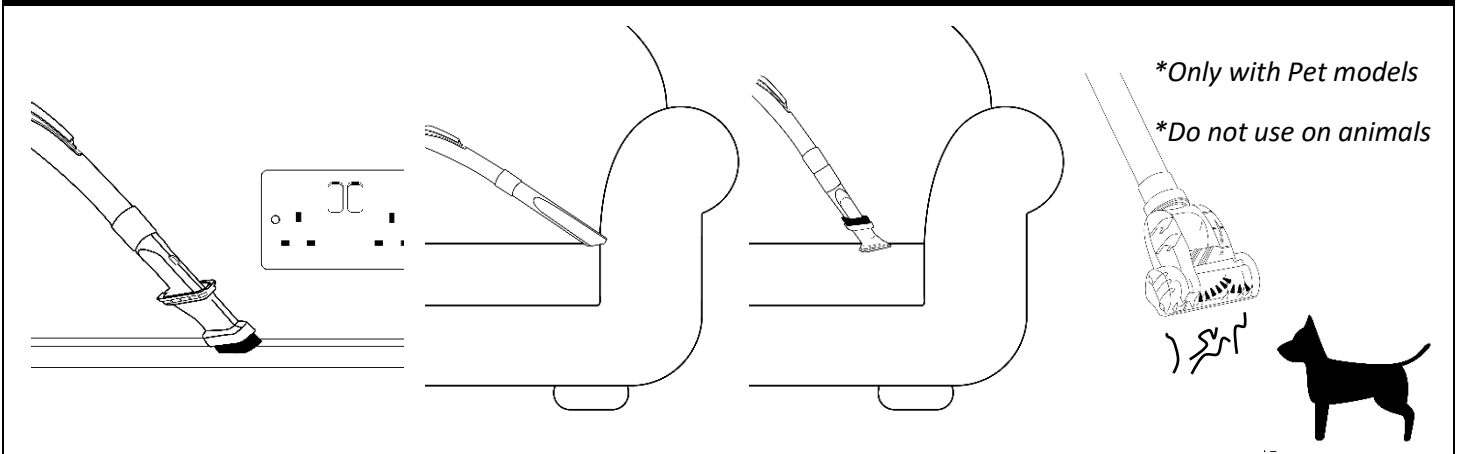

EMPTYING THE BIN

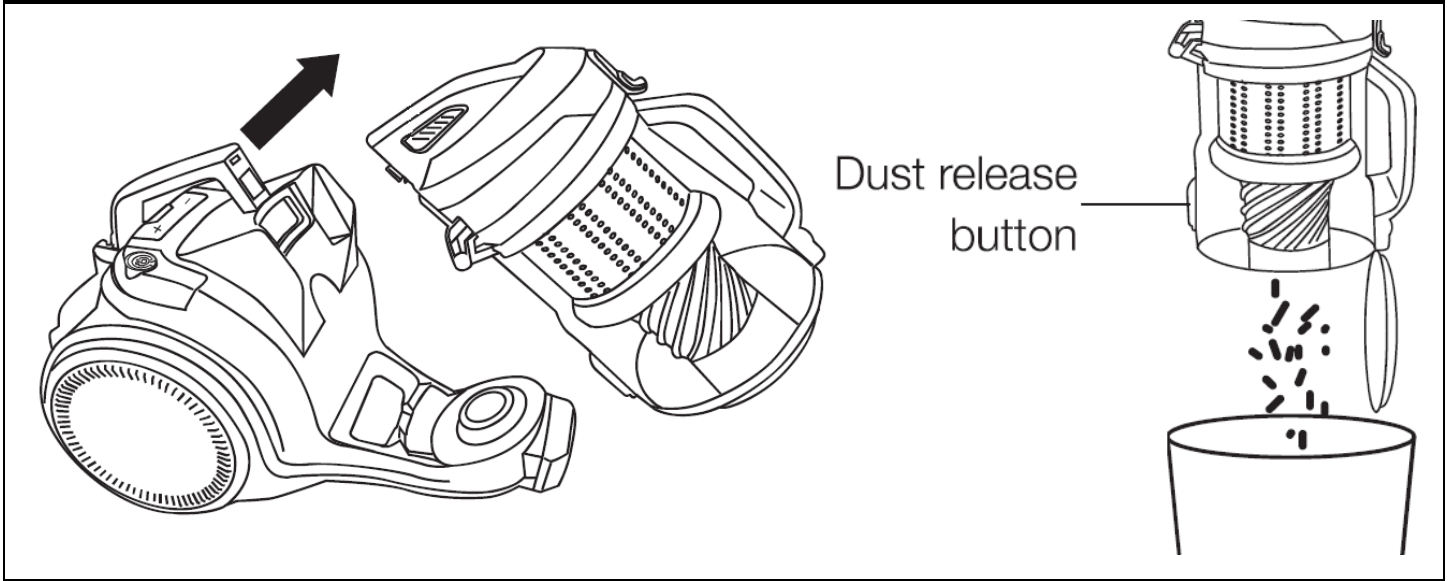

CARPETS OR HARD FLOORS

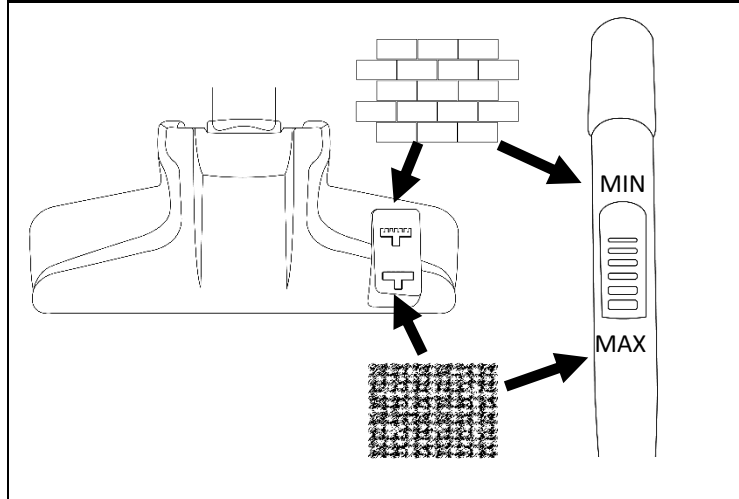

CORD REWIND

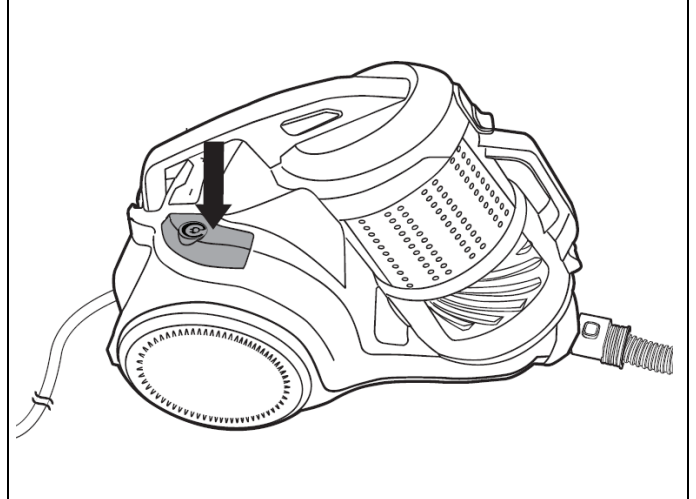

CHECKING FOR BLOCKAGES

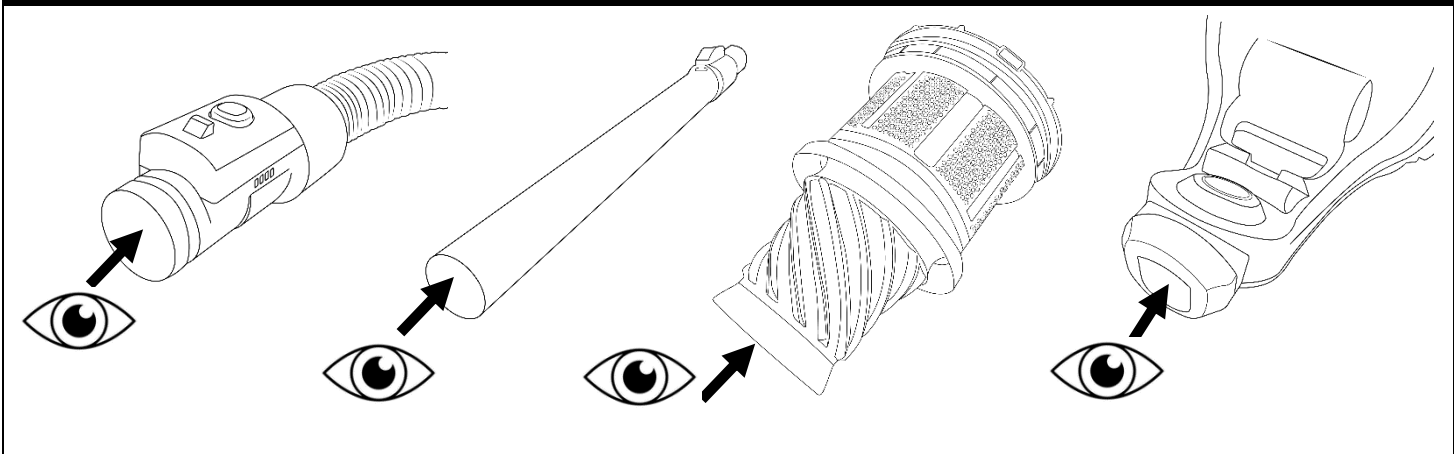

IMPORTANT! WASH THE FILTERS

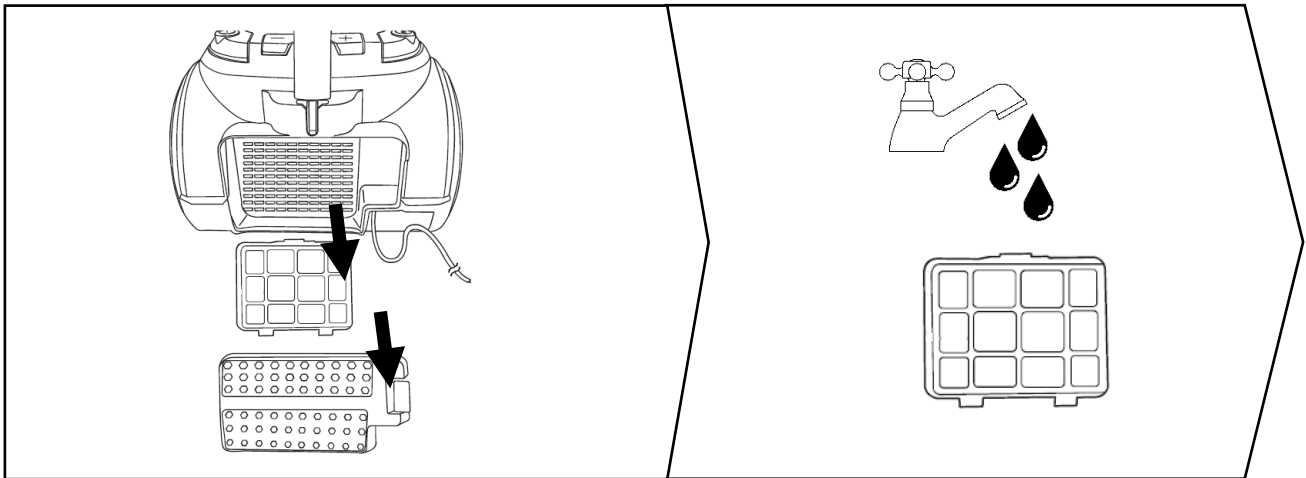
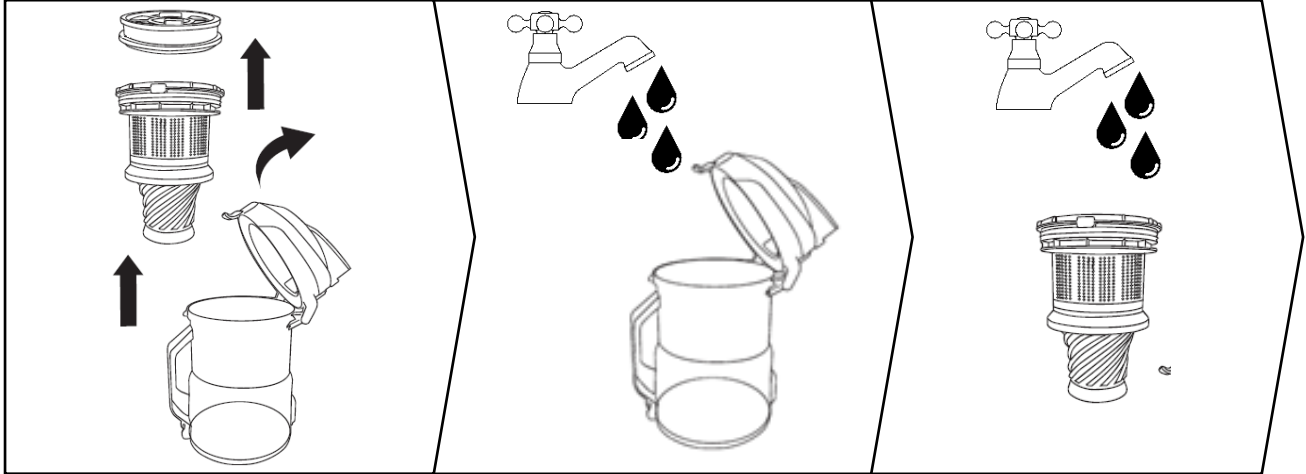

**REGISTER YOUR
FREE 1 YEAR
GUARANTEE
TODAY**

WASH FILTERS

Wash the filters with cold water at least once a month

**1
MONTH**

IMPORTANT! WASH THE FILTERS

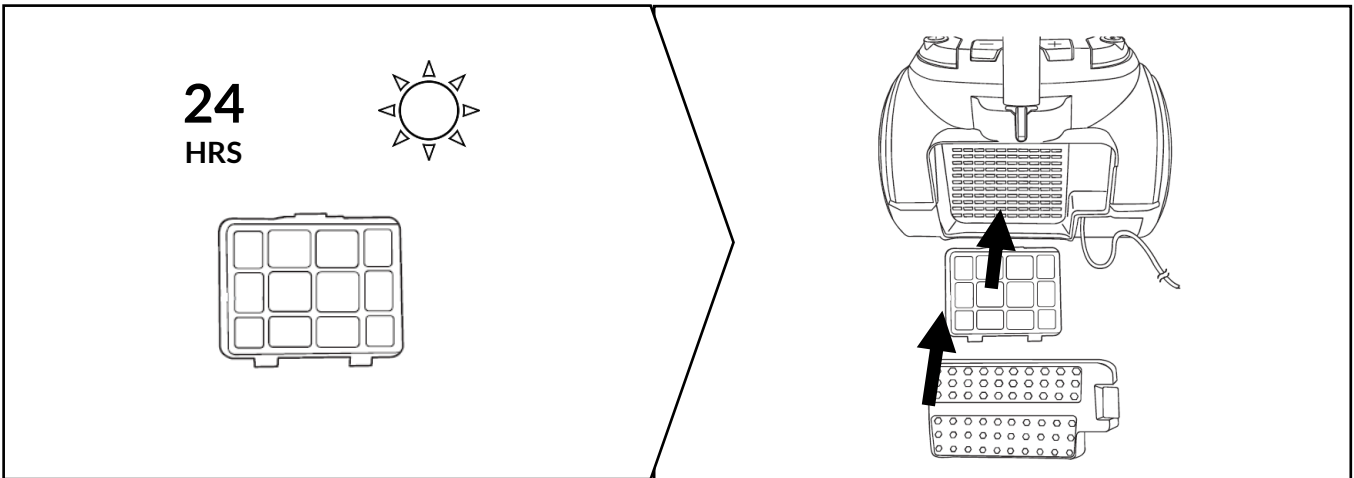
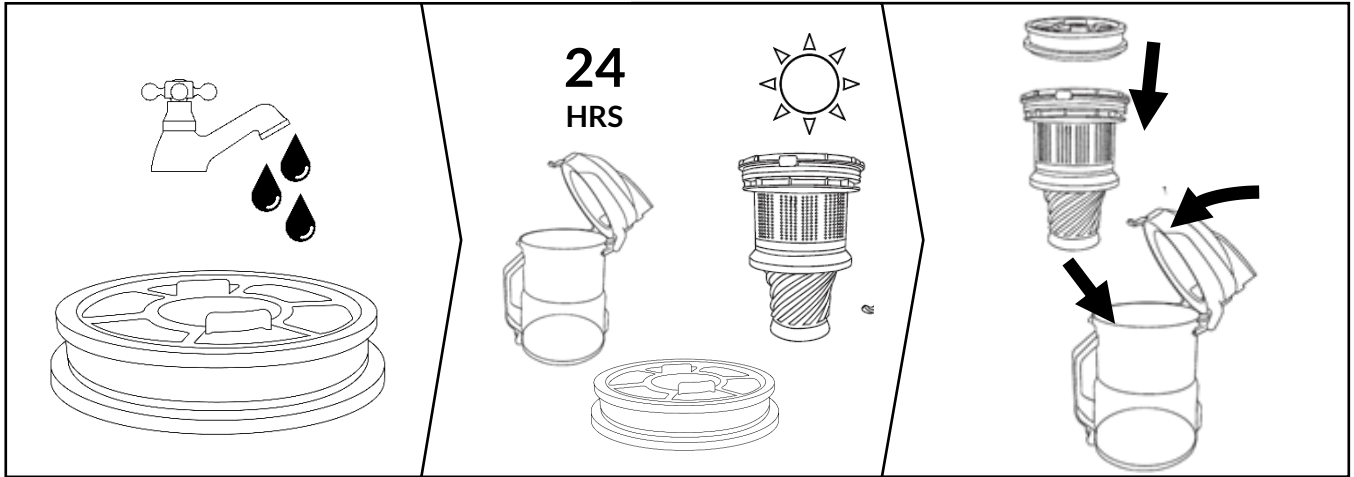

**REGISTER YOUR
FREE 1 YEAR
GUARANTEE
TODAY**

WASH FILTERS
Wash the filters with cold water at least once a month

1
MONTH

PROBLEM SOLVING

The vacuum cleaner doesn't switch on	<ul style="list-style-type: none">• Check the vacuum is plugged in• Check the socket is switched on• Check another appliance in the socket• Check for any obvious signs of damage to cord or plug• If recently used, allow to cool for 1 hour then try again
The suction is decreasing and dirt is not adequately being picked up	<ul style="list-style-type: none">• Check if the dust canister is full; if so, empty it• Clean the filters following the instructions in this manual• Check there are no blockages in the hose, and clear any obstructions
Vacuum cleaner is over heating	<ul style="list-style-type: none">• Check the filters are clean
Dust is coming out of the vacuum	<ul style="list-style-type: none">• The dust canister has not been fitted correctly. Refit the canister following the instructions in this manual.
The air exhausted from the vacuum smells	<ul style="list-style-type: none">• Clean the filters, hose, and dust container following the instructions in this manual
The vacuum cleaner has cut out	<ul style="list-style-type: none">• Allow the vacuum to cool for 1 hour. Clean all filters and dust containers before trying to use again.

If you are still experiencing difficulties with the appliance please contact us **BEFORE** returning the appliance to the retailer it was purchased from:

Website: <https://mda.russellhobbs.com>

Telephone: 0345 209 7461

Address: Product Care Customer Service, Green Bank Business Park, Hindley Green, Wigan, WN2 4AY

IMPORTANT!

WASH FILTERS

Wash the filters with cold water at least once a month
The filters may require more frequent washing if vacuuming fine dust

1

MONTH



Russell Hobbs

This product is guaranteed for 12 months from the date of the original purchase. If any defect arises due to faulty materials or workmanship, the faulty product must be returned to the place of purchase.

By registering your product you will get an additional year guarantee free of charge. Additional cover can be purchased through the website.

REGISTER ONLINE

Visit our website to register your full parts and labour guarantee online.

<https://mda.russellhobbs.com>

REGISTER BY PHONE

Call our friendly Product Care team.

0345 209 7461

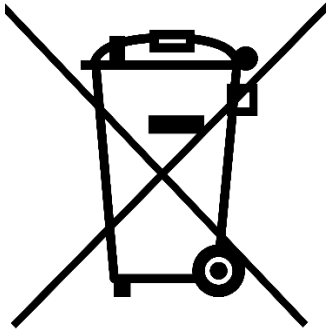
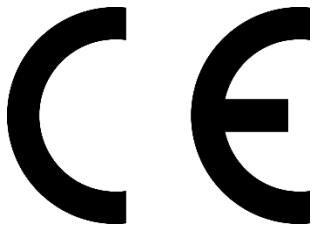

The 'wheelie bin' symbol is known as the 'Crossed-out wheelie bin Symbol'. When this symbol is marked on a product/batteries, it means that the product/batteries should not be disposed of with your general household waste. Only discard electrical/electronic/battery items in separate collection schemes, which cater for the recovery and recycling of materials contained within. Your co-operation is vital to ensure the success of these schemes and for the protection of the environment. For your nearest disposal facility, visit www.recycle-more.co.uk or ask in store for details.

We reserve the right, due to possible changes to design, to alter the instruction manual without prior notice.

NOTES



Russell Hobbs

Russell Hobbs is a registered trademark used under license from
Spectrum Brands (UK) Ltd. Made under license by G2S Limited, Wigan,
WN2 4AY

Russell Hobbs Support: call 0345 209 7461 or visit
<https://mda.russellhobbs.com>