



The ultimate outdoor grilling experience.

Phone: 1 (888) 287-3333 ♦ Fax: 1 (877) 855-5373 ♦ #106-2480 Mt. Lehman Road, Abbotsford, BC V4X 2N3

## OWNER'S MANUAL for LUX700



**For CART Models:**  
**JLS700-LP** (Liquid Propane)  
**JLS700-NG** (Natural Gas)

### **Important Notice**

Please read ALL safety notices on Pg. 2-3  
before assembling or operating this grill.



---

# !SAFETY WARNINGS!

---

**IMPORTANT:** Please read and understand all warnings and precautions before using your gas grill.



## !DANGER!

If you smell gas:

1. Shut off gas to the appliance.
2. Extinguish any open flame.
3. Open lid.
4. If the odor continues, keep away from appliance and immediately call your gas supplier or your fire department.



## !WARNING!

1. Do not store or use gasoline or other Flammable liquids in the vicinity of this or any other appliance.
2. An LP cylinder not connected for use shall not be stored in the vicinity of this or any other appliance.

- 1 The installation of this appliance must conform with local codes or, in the absence of local codes, with the National Fuel Gas Code, ANSI Z223.1/NFPA54, or the Natural Gas and Propane Installation Code, CSA B149.1
- 2 The installation of this appliance must be electrically grounded in accordance with local codes, or, in the absence of local codes, with the National Electric Code, ANSI/NFPA 70, or the Canadian Electrical Code, CSA C22.1
- 3 This appliance is for outside use only, and shall not be installed or used in any home, building, garage, or any other enclosed area.
- 4 This appliance shall not be installed in or on any boat or recreational vehicle.
- 5 Do not use this outdoor cooking gas appliance for any purposes other than intended.
- 6 Clearance to Combustibles must be maintained at all times, as specified in page 8 of this manual.
- 7 Always have a certified gas fitter install all Propane or Natural Gas fuel lines, Hose Quick Connect Boxes, Conversion Kits, or any other gas related items.
- 8 This grill is set up from the factory for use with either Propane Gas (LP), or Natural Gas (NG). Please ENSURE that your grill is correctly configured and labeled for the gas you intend to use.
- 9 Do not use gasoline, alcohol or other volatiles for lighting.
- 10 Propane (LP) gas supply cylinders must be constructed and marked in accordance with the specifications for propane gas cylinders of the US Department of transport (DOT) CFR 49 or the National Standards of Canada, CAN/CSA B339, Cylinders, Spheres and Tubes for the Transportation of Dangerous Goods.
- 11 For appliances designed to use a CGA 791 Propane Gas Connection: Place dust cap on cylinder valve outlet whenever the cylinder is not in use. Only install the type of dust cap on the propane cylinder valve outlet, this provided with the cylinder valve. Other types of caps may result in leakage of propane gas.
- 12 Never fill any LP Gas Cylinder more than 80 percent full. Dented and rusted propane cylinders may be hazardous and must be checked by a propane gas supplier, before use. Do not store a spare LP-gas cylinder under or near this appliance.
- 13 **WARNING:** if the information in #7, #8 and #12 are not followed exactly, a fire causing death or serious injury may occur.
- 14 To prevent propane from entering the regulator valve & causing a potential hazard, please ensure that the propane cylinder is at a lower level than the regulator when in use.

- 15 Please note that propane (LP) is explosive under pressure, heavier than air, and settles and pools in low areas, which can create an explosion hazard.
- 16 When configured for Natural Gas, please ensure that the supply pressure matches the required specifications in this manual.
- 17 The outdoor cooking gas appliance and its individual shutoff valve must be disconnected from the gas supply piping system during any pressure testing of that system at test pressures in excess of 0.5 psi (3.5 kPa).
- 18 The outdoor cooking gas appliance must be isolated from the gas supply piping system by closing its individual manual shutoff valve during any pressure testing of the gas supply piping system at test pressures equal to or less than 0.5 psi (3.5 kPa).
- 19 When connecting the electric cord, first connect the plug to the outdoor cooking gas appliance, and then plug the appliance into the outlet.
- 20 Use only a Ground Fault Interrupter (GFI) protected circuit with this outdoor cooking gas appliance.
- 21 Keep any electrical supply cord and the fuel supply hose away from any heated surfaces.
- 22 Inspect fuel supply hose for damage before each use. If excessive wear, abrasion, or cracks are present, the hose **MUST** be replaced with a genuine Jackson Grills replacement part, prior to using this outdoor cooking gas appliance (Contact your nearest dealer for assistance).
- 23 Do not let the cord hang over the edge of a table or touch hot surfaces.
- 24 To protect against electric shock, do not immerse cord or plugs in water or other liquid.
- 25 Unplug electrical equipment from the outlet when not in use, and before cleaning. Allow appliance to cool before putting on or taking off parts.
- 26 Do not operate any outdoor cooking gas appliance with a damaged cord, plug, or after the appliance malfunctions or has been damaged in any manner. Contact the manufacturer for repair.
- 27 Never remove the grounding plug or use with an adapter of 2 prongs, and;
- 28 Use only extension cords with a 3 prong grounding plug, rated for the power of the electrical equipment, and approved for outdoor use with a W-A marking.
- 29 Do not use this grill until it is **COMPLETELY** assembled, all parts are securely installed, and leak testing has been completed.
- 30 Before using this outdoor cooking gas appliance, inspect the burners to ensure that they are correctly inserted over the orifices. Inspect by using a flashlight to view the burner inlets from underneath the front console. When correctly positioned, the gas valves outlets (with the orifices) will be inserted into the burner inlets. If necessary, remove and reinstall burner(s) correctly. (See Assembly Section, p.7 for more details).
- 31 Do not attempt to move this grill while lit. Always position your grill on a hard level surface away from any combustible materials, including wood, flammable liquids or vapors, plastics, etc.
- 32 Do not leave a lit grill unattended. Keep children and pets away from this grill at all times.
- 33 Always open the grill lid slowly & carefully as heat and steam in the grill can cause severe burns.
- 34 Do not touch any metal surfaces on this grill until it has completely cooled to avoid burns, unless wearing protective gear. (Pot holders, gloves, BBQ mittens, etc.)
- 35 It is essential to keep the grill clean and free of obstructions and debris. Check burner/Venturi tubes regularly for insects and insect nests; a clogged burner tube can lead to a fire beneath the grill.
- 36 Do not alter this grill in any manner.

---

## Table of Contents:

---

Certification & Testing:	5
Unpacking Your Grill:	5
Parts Checklist:	5
Contact Us:	6
Owner Registration:	6
Tools Required for Assembly:	7
Assembling & Preparing your Grill:	7-8
Clearance to Combustibles:	8
Propane Gas Connection:	9-10
Natural Gas Connection:	11
Leak Testing:	12
Installer Final Checklist:	13
Gas Conversion:	14
Lighting Instructions:	14-15
Grilling and Rotisserie Cooking:	15-17
Cleaning & Maintenance:	17-19
Casters:	19
Storing your Grill:	19
Trouble Shooting:	20
Exploded Parts View:	21
Parts List:	22
Warranty:	23



---

## Certification and Testing:

---

This appliance has been tested by Labtest Certification Inc. (LC), and has been tested to ANSI Z21.58b-2012, & CSA 1.6b-2012, and Certified for Canada and the USA.

---

## Unpacking Your Grill:

---

Please open your packaging carefully and set aside all loose components. Once unpacked, please match the parts to the list shown below. Check all components for possible damage before assembling your grill. Most of your portable grill has been factory assembled. However, there are still some items that must be unpacked and placed in the correct position, in your barbecue. For assembly instructions please refer to the next Section;

---

## Parts Checklist:

---

### **!WARNING!**

Exercise caution when handling stainless steel; metal edges may be sharp and can cause injury.



### **TECH-TIP**

Do not throw away packaging until you have confirmed that all parts are present.

### **PARTS CHECKLIST:**

1	x	Main Firebox & Pedestal
2	x	Side Shelves
1	x	AAA Battery for Ignition
4	x	Flame Diffusers
2	x	Cook Grids
1	x	Warming Rack
1	x	Complete Rotisserie Kit
1	x	Owner's Manual
1	x	Spare Set of Rubber Lid Bumpers
1	x	Grease Cup
1	x	PROPANE MODELS: Propane (LP) Hose & Regulator <b>OR</b>
1	x	NATURAL GAS MODELS: NG Hose w. Quick Release, and 4.5" Regulator

---

## Special Message to Our Customers:

---

All of us at Jackson thank you, for choosing a Jackson Grill! This appliance was designed, engineered, and built with quality components and we are confident that it will provide you with years of excellent operation. Please take the time to read the entire manual and familiarize yourself with all the features of the Jackson Grill. This manual also contains important safety information and operation instructions. Please write your barbecue's serial # in the space below, and ensure that this manual remains handy to the barbecue for quick reference. To obtain replacement parts for your Jackson Grill, contact your local dealer. If you have any questions please call us anytime at the number below: (Please have your model and serial number at hand)

**Grill Model: JLS700-LP or JLS700-NG**

**Serial Number:** \_\_\_\_\_

Write your serial number here for future reference.

OWNER REGISTRATION: Please take the time to fill out and return a Warranty Registration Card, or on-line at [www.jacksongrills.com](http://www.jacksongrills.com) or simply fill in the form below and mail or fax to: (Thank you for your help!)

**Jackson Grills**  
**#106-2480 Mt. Lehman Rd.**  
**Abbotsford, BC.**  
**Canada V4X 2N3**

**Customer Support (Tel):**  
**Customer Support (E-mail):**  
**Fax:**  
**Parts Ordering:**

**1 (888) 287-3333 or**  
**info@jacksongrills.com**  
**1 (877) 855-5373**  
**Contact your Dealer**

---

**Please complete and return within 10 days. Thank you.**

Title: Mr. Mrs. Ms. Miss (Circle One)

First Name: \_\_\_\_\_ Initial: \_\_\_\_\_ Last Name: \_\_\_\_\_

Street: \_\_\_\_\_ Apt. #: \_\_\_\_\_

City: \_\_\_\_\_ State/Prov.: \_\_\_\_\_ Zip/Postal: \_\_\_\_\_

Phone: \_\_\_\_\_ Email: \_\_\_\_\_

Date Purchased: \_\_\_\_\_ Dealer: \_\_\_\_\_

Model: \_\_\_\_\_ Serial #: \_\_\_\_\_

Comments: \_\_\_\_\_  
\_\_\_\_\_  
\_\_\_\_\_  
\_\_\_\_\_  
\_\_\_\_\_

**Dear Grill Owner; please keep this manual for future reference.**

---

## Tools Required for Assembly:

---

Please use the proper tools to simplify installation and avoid injury or damage to your grill.

### ■ INSTALLER SUPPLIED TOOLS:

- 1 x Large Phillips Screwdriver
- 1 x Small Phillips Screwdriver
- 1 x Small Crescent Wrench
- 1 x Large Crescent Wrench

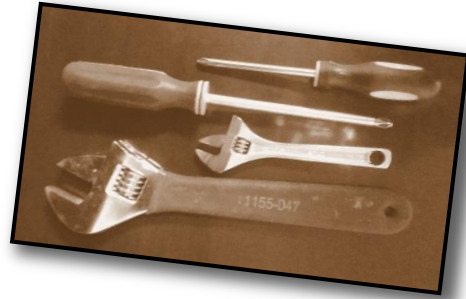

---

## Assembling & Preparing your Grill:

---

### ■ CHECK BURNER FIT on ORIFICES:

1. Inspect burners to ensure that they are all inserted correctly onto the orifices (AKA the outlet of the valves; Fig 1)
2. If any burner is NOT correctly installed over the valve as shown in Fig 1, remove the burner retaining clip, remove the burner, and reinstall correctly.

Tip of brass orifice, on end of valve; correctly hidden inside burner.

Figure 1

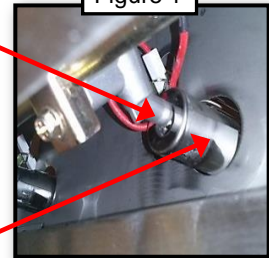

Main burner

### ■ INSTALL FLAME DIFFUSERS & COOK GRIDS:

1. Remove the flame diffusers, grids & warming rack from the packaging.
2. Install each diffuser directly above each burner by setting them into the slotted ledges, in the front and rear of the firebox. (Fig. 2)
3. Once the flame diffusers have been installed, set the cooking grids on the upper ledges of the firebox in the grill, with the grill bars oriented front to rear.
4. Install the warming rack above cook grids, on the 2 brackets located on the left & right inner walls of the inner hood.

Figure 2



### ■ PREPARE REAR BURNER IGNITER:

1. Unscrew the plastic/rubber cap from the rear burner ignition module, and insert supplied AAA battery with the positive end facing out. (Fig. 3)
2. Re-install cap.

Figure 3



■ **INSTALL SIDE SHELVES (2):**

1. Install both Side Shelves, using 4 screws per shelf (supplied). (Fig. 4 Next Page)
2. Drop Cutting Board into opening in RH Side Shelf (Fig. 5)

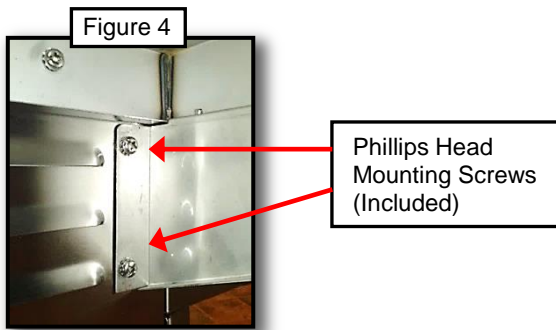

■ **INSTALL ROTISSERIE KIT: (For Rotisserie Cooking)**

1. Carefully remove the rotisserie kit parts from the packaging.
2. Install the motor mounting bracket supplied to the left hand side of the inner hood. (Fig. 6)
3. Install the motor on the motor bracket.
4. Place the forks and counter balance on the rotisserie rod in the desired location.
5. Place the rotisserie rod into the motor. Align the rotisserie rod groove over the right inner hood wall and drop it into the cut out provided on the inner hood. (Fig.7)

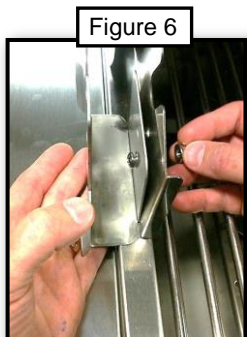

---

## Clearance to Combustibles:

---

- |   |                          |
|---|--------------------------|
| A) <b>TOP:</b> from top of hood to any *combustibles above grill:<br>*Such as decks, ceilings, hanging plants, etc. | <b>6 feet minimum</b>    |
| B) <b>REAR:</b> from rear of unit to any combustibles behind grill:   | <b>12 inches minimum</b> |
| C) <b>SIDE:</b> from the outside edges of side shelves to any adjacent combustibles:                                | <b>2 inches minimum</b>  |

**!WARNING!**  
Please allow extra space when the grill is backed up to vinyl siding; exhaust exiting the rear of the grill can warp or melt the vinyl.



---

# Propane Gas Connection:

---

- **FUEL TYPE:** The following instructions are for a Propane configured grill. **Operating Pressure: 11" WC.**
  
- **HOSE & REGULATOR:** Use only the propane hose and regulator supplied with your Propane grill. For replacement Hose & Regulator assemblies, please contact your local dealer and ask for part #JF-70. Only use genuine Jackson replacement parts.
  
- **PROPANE CYL. REQUIREMENTS & SPECIFICATIONS:**
  1. Maximum Cylinder Size: 20 lbs. (9 Kg)
  2. Measurement: (approximately) Diameter: 12"(30.5cm) X Height: 18" (45.7cm):
  3. USA: All LP cylinders used with this grill must be constructed and marked in accordance with the *Specifications for LP (Propane) Gas Cylinders* of the US Department of Transportation (D.O.T.). Refer to your propane cylinder collar for markings.
  4. CANADA: All propane cylinders used with this grill must be constructed and marked in accordance with the National Standard of Canada, CAN/CSA-B339; *Cylinders, Spheres and Tubes for the Transportation of Dangerous Goods and Commission*. Refer to your propane cylinder collar for markings.
  5. Cylinder supply system must be arranged for vapor withdrawal.
  6. Cylinder must be equipped with a collar to protect the outlet valve.
  7. Cylinders must be rust and dent free: a dented or rusty propane cylinder may be hazardous, and must be professionally inspected before use.
  8. Cylinders must be equipped with QCC Type 1 (Quick Closing Coupling) outlet.
  9. Propane Cylinders must be equipped with a safety relief valve.
  10. UL listed Overfill Protection Device (OPD); This OPD safety feature is identified by a unique triangular hand wheel. **Only use cylinders equipped with this type of valve. (Fig. 8)**

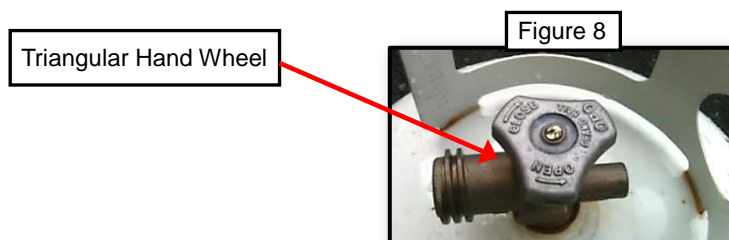

- **WHAT TO DO if SAFETY VALVE has tripped:**
  1. Turn off Propane Cylinder.
  2. Disconnect the Propane Hose and Regulator from the Propane Cylinder.
  3. Turn Gas Valve on slowly.
  
- **HANDLING PROPANE CYLINDERS: (NOT Included with Grill)**
  1. Government regulations prohibit shipping full Propane cylinders. New cylinders (not included) must be taken to a Propane filling station for filling.
  2. A full cylinder is under high pressure; always handle with care, and transport secured and in an upright position. Protect the valve from accidental damage.
  3. Do not tip the propane cylinder while connecting it to your grill's regulator
  4. If the cylinder is tipped over while connected to your grill, shut it off and disconnect it; then have it checked before use.

## ■ STORING PROPANE CYLINDERS:

1. Place dust cap on cylinder valve outlet whenever the cylinder is not in use. Only install the type of dust cap on the cylinder valve outlet that is provided with the cylinder valve. Other types of caps or plugs may result in leakage of propane.
2. Store all propane cylinders outdoors in a well-ventilated area.
3. Do not store cylinders in direct sunlight or near a source of heat or combustion.
4. Propane cylinders must be REMOVED from your grill; when the grill is to be stored indoors.
5. Keep all propane tanks out of reach of children.
6. If your grill is stored outside, the propane tank may be left connected to the grill. Turn off propane tank valve when grill is not in use.

## ■ INSTALLING & CONNECTING A PROPANE CYLINDER TO THE GRILL:

1. Make sure tank valve is in its full off position (turn clockwise to stop).
2. Check tank valve to ensure that is equipped with external (male) threads (i.e. QCC-1 type connector).
3. Make sure all burner knobs are in their off position.
4. Remove the protective dust cap from the cylinder valve. Always reuse dust cap when storing a cylinder.
5. Inspect valve connection port and regulator; look for any damage or debris. Inspect hose for damage. Never attempt to use damaged or plugged cylinders. Contact your local propane gas dealer for repair.
6. Remove the Propane Mount Block Off. (Fig. 9)
7. Place the Propane Tank into the Tank Mounting Hole in the pedestal of the grill. (Fig. 10). Always install the propane cylinder in an upright position with the valve at the top, to facilitate vapor withdrawal (Fig. 10).
8. Attach the Propane Hose and Regulator by hand-tightening the black plastic Quick Coupling Connector (QCC) nut clockwise to a positive stop. Do not use a wrench to tighten as this may damage the nut and cause leaks. (Fig. 11)

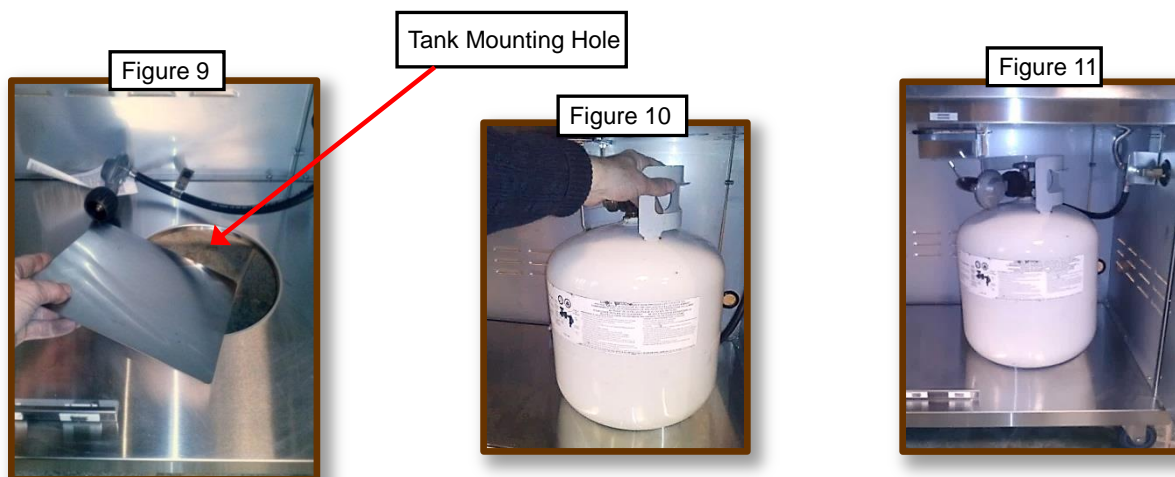

9. Open tank valve SLOWLY (counterclockwise) until fully open. Use a soapy water solution to check all connections for leaks before lighting grill. If a leak is found DO NOT use the grill. Turn gas off and call a professional gas fitter to repair the leak.

## ■ DISCONNECTING PROPANE CYLINDER:

1. Turn all the grill knobs to off.
2. Turn the tank valve off fully (turn clockwise to stop).
3. Detach the regulator from tank valve by turning the black (QCC) nut counterclockwise.
4. Install the protective cap back onto the threads of the propane cylinder valve.

---

# Natural Gas Connection:

---

## **!WARNING!**

- 1 Never insert any foreign objects in valve outlet, as this may cause leaks.
- 2 Do NOT connect this grill to unregulated Propane systems such as in a motor home or camper trailer. System pressure **MUST** be regulated before hook up.
- 3 Do NOT use this grill until leak tests have been completed.
4. If a gas leak is detected and cannot be stopped, call the fire department.

### ■ FUEL TYPE:

The following instructions are for Natural Gas configured grills ONLY. **Operating Pressure = 4" WC.**

### ■ INSTALLATION CODES:

Please refer to page three, item #1 of this manual.

### ■ CONNECTING THE NATURAL GAS HOSE:

1. Use only the natural gas hose supplied with your Natural Gas configured grill.
2. Install the supplied hose onto the flare nut nipple on the fuel regulator, located on the RH inner side of the pedestal. DO NOT USE SEALANT of any kind. Tighten using a 3/4" open end wrench or a crescent wrench. Hold the regulator nut with a second wrench while tightening.
3. A female quick release (Hansen plug) is included with the grill. Install it onto the homeowner's preexisting natural gas quick release box. NOTE; pipe dope or Gas Rated Teflon tape must be used to seal the threads at this connection.
4. Check supply pressure to ensure that incoming pressure is no higher than 7" Water Column.
5. Use a soapy water solution to check all connections for leaks before lighting grill. If a leak is found DO NOT use the grill. Turn gas off and call a professional gas fitter to repair the leak.

## **!WARNING!**

- 1 Never insert any foreign objects in the quick release or Natural Gas hose, as this may cause leaks.
- 2 Pressure from the gas source for this grill **MUST NOT** exceed 14 inches of Water Column; using a grill at higher pressures could result in property damage, and injury or death.\*\*
- 3 Do NOT use this grill until leak tests have been completed.
4. If a gas leak is detected and cannot be stopped, call the fire department immediately.

\*\* NOTE; this is the maximum inlet pressure rating for the included Natural Gas Regulator, part number JF-99

---

# Leak Testing:

---

## ■ GENERAL:

1. Although all gas connections on the grill are leak tested at the factory, a complete gas tightness check must be performed at the installation site. This is mandatory due to possible mishandling during shipping (which could loosen fittings), or excessive pressure unknowingly being applied to the unit.
2. Periodically check the whole system for leaks, or immediately check if the smell of gas is detected.

## ■ BEFORE TESTING:

1. Make sure that all packing materials are removed from the grill and cart.
2. Do not smoke while leak testing.
3. Never leak test with an open flame.
4. Make a soap solution with one part dish soap and one part water. Prepare a spray bottle, brush, or rag to apply the solution to the connections. For the initial leak test, make sure the propane cylinder is full.
5. Grill must be leak tested outdoors in well-ventilated area, away from ignition sources such as gas fired or electrical appliances, and flammable materials.

## ■ TESTING PROCEDURES:

1. Make sure all control knobs are in the "OFF" position.
2. Make sure the regulator is connected to the propane cylinder tightly. For Natural Gas, ensure that the gas hose is correctly connected at the quick release box pre-installed on the home. (Not included with grill).
3. Completely open propane cylinder valve by turning SLOWLY counter clockwise. If you hear a "POP" sound, turn gas off IMMEDIATELY, it indicates a heavy leak at the connection. Call your gas dealer or fire department.
4. Check every connection from the propane cylinder or natural gas quick release, up to and including the connection to the manifold pipe assembly (the pipe that goes to the burner) by brushing or spraying the soapy solution on the connections.
5. If soap bubbles appear, there is a leak. Turn off propane cylinder valve or natural gas quick release IMMEDIATELY and retighten connections, Turn on gas, and recheck for leaks.
6. Always close the propane cylinder valve and/or disconnect the Natural Gas hose, after leak test, when the grill is not in use.
7. Only those parts recommended by the manufacturer should be used on the grill. Substitution can void the warranty. Do not use the grill until all connections have been checked and do not leak.

## ■ LEAK TEST SAFETY TIPS:

1. Always check for leaks after every propane cylinder change.
2. Always check for leaks at every connection before use. (Including natural gas quick release hook up)
3. If any grease or hot products fall on the valve, regulator, hose or any part that conveys gas, shut gas off immediately, check the cause and rectify it. Perform a complete leak test before reusing the grill.
4. If the smell of gas is detected, immediately shut off gas or disconnect from source, and repair leaks before further attempts are made to use the grill.

### **!WARNING!**

**Propane and Natural Gas are very flammable; exercise extreme caution while checking for, and repairing gas leaks.**

## Installer Final Check List:

- Ensure that clearances to combustible materials are maintained per specifications listed in this manual.
- Make sure that all internal packaging has been removed.
- Check that the burners are sitting properly on orifice end of the valves. (p.7)
- Check grill label to confirm that the gas configuration matches the fuel being supplied
- When using natural gas; ensure that incoming pressure is at 4" WC
- For propane grills confirm that inlet pressure is at 11" WC; NOTE that the original Jackson regulator and hose are preset to 11" WC.
- Ensure that all the gas knobs turn freely.
- Leak test grill and all gas connections.
- Grill test fired, and all functions working and in good order.
- User informed of gas supply shut off valve location.
- Owner's manual given to grill user.



Optional # JGSB Side Burner

### Advertisement:



Introducing the ISLAND GRILLSTONE™ Check out this fabulous new way to enhance your cooking! Quarried from natural volcanic rock and then cut into slabs, it is the ideal accessory for grilling veggies, seafood, or marinated meats. Drops right onto your grill!



#### Round Grillstone

Dimensions: 14" round by 3/4"  
Weight: 12.5 lbs (5.67 kg)



#### Square Grillstone

Dimensions: 12"x12" x 3/4"  
Weight: 9.9lbs (4.5 kg)



---

## Fuel Conversion:

---

This grill is convertible to Natural Gas or Propane when needed, with the installation of the appropriate Gas Conversion Kit. (See parts list, p.22) The kit should be installed by a qualified gas fitter. Please contact your local dealer for information.

---

## Grill Lighting Instructions:

---

### 1. BEFORE LIGHTING:

- Always inspect the gas supply hose before turning the gas "ON". If there is evidence of cuts, wear, or abrasion, it must be replaced before use. Use only a manufacturer approved replacement hose.
- Check all gas connections for leaks before each use. Do not light grill if gas odor is present.

### 2. TO LIGHT MAIN BURNERS OF THE GRILL: (Fig. 12)





- Read instructions before lighting (see labels on top edge of the pull out grease tray)
- Open lid prior to lighting your grill.
- Turn all knobs to "OFF" then open the propane cylinder valve, OR natural gas valve on your gas connection. NOTE: Always keep your face and body averted when lighting.
- Push in and rotate each control knob counter clockwise slowly, to the high position . (When rotating the knob, rotate for a two second count: do NOT turn the knob rapidly) The built-in igniter  will click and spark, thus lighting the torch light pilot flame, then the main burner. If the burner does not light IMMEDIATELY turn the knob to off and wait 5 minutes for gas to dispel and repeat the lighting procedure.
- Follow match lighting instructions if burner can't be lit after repeating 3-4 times.

Figure 12

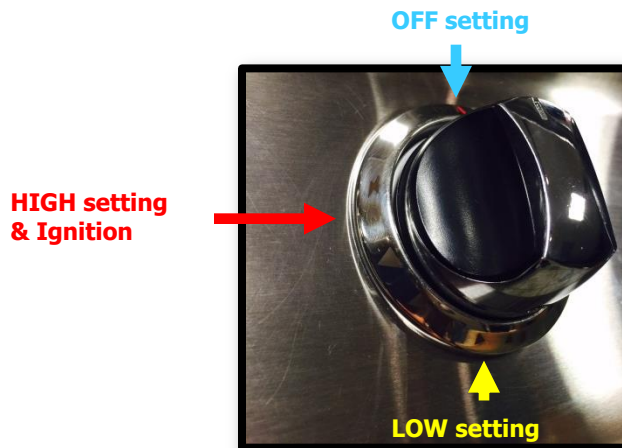

### 3. TO LIGHT MAIN BURNERS USING A MATCH OR BARBECUE LIGHTER: (Temporary Solution when Ignition is disabled)

- Read instructions before lighting.
- Open the lid during lighting, and remove cook grids.
- Turn all knobs to "OFF" then open the propane cylinder valve, OR natural gas valve on your gas connection. NOTE: Always keep your face and body averted when lighting.
- A long stove match or BBQ lighter must be used to reach the burners.
- Do NOT drop a burning match into grill for lighting purposes; hold the match in the desired spot.
- Push and turn the main burner knob to the high position , then release.
- Light burner by match at the front end of the burner tube. Make sure the burner lights and stays lit.
- If necessary, call your dealer or the Jackson help line, for assistance with repairing your ignition system.

#### 4. FLAME CHARACTERISTICS: (Fig. 13)

- Check for proper burner flame characteristics. Each burner is adjusted prior to shipment; however, variations in the local gas supply may mean subtle adjustments may be necessary.
- Burner flames should be blue and stable. There should be no excessive noise, or flame lifting. If any of these conditions exist please call your Dealer. If the flame is yellow, it indicates insufficient air. If the flame is noisy and tends to lift away from the burner, it indicates too much air.
- Note small yellow tips are okay

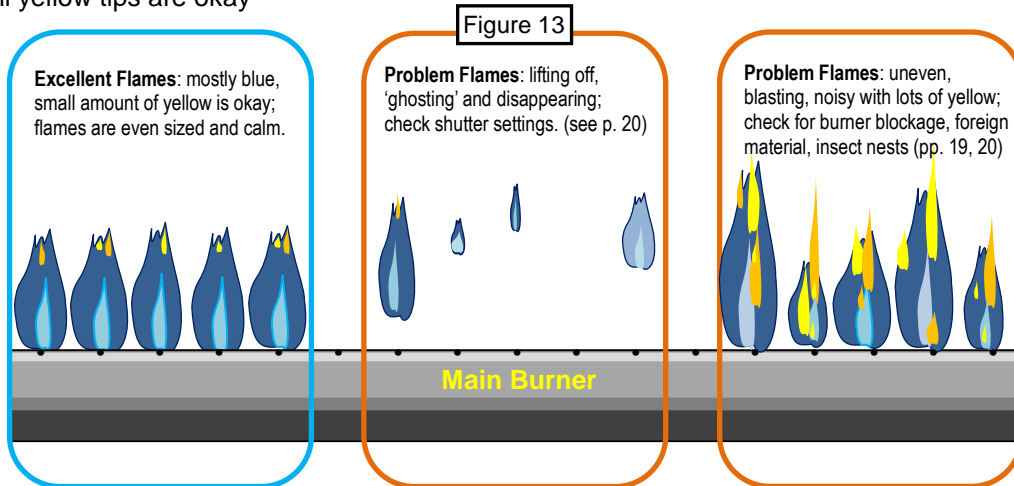

#### 5. LIGHTING THE ROTISSERIE BURNER:

- Open lid during lighting.
- Turn all knobs to "OFF" then open the propane cylinder valve or the natural gas valve at the natural gas quick release.
- Push and turn rear burner control knob to  (high) then push and hold igniter button until burner lights. Ignition should occur within 5 seconds.
- If burner does not light, wait 5 minutes for gas to clear and try again.
- Follow match lighting instruction if burner can't be lit after repeating above steps 3-4 times.
- Once the burner is lit, the rotisserie burner will attain a red glow across its entire front surface.
- DO NOT run the rotisserie burner with the main burners.



#### 6. LIGHTING THE ROTISSERIE BURNER BY MATCH:

- Read instructions before lighting.
- Open the lid during lighting.
- Push and turn the rear burner knobs slowly to  (high position, then release.
- Light by match with left hand. Make sure the burner lights and stays lit.

**TECH-TIP**

Remove Warming Rack before using your rotisserie burner; otherwise the rack may be damaged due to excessive Heat.

---

## Grilling and Rotisserie Cooking:

---

#### TOTAL GAS CONSUMPTION:

Total gas consumption per hour, per burner: **MODEL JLS700 (ALL):**

Main burners:	15,000 Btu/hr. X 4	=	60,000 BTU/hr.
Rear burner:	13,500 Btu/hr. X 1	=	<u>13,500 BTU/hr.</u>
Total:		=	73,500 BTU/hr.

## **!WARNING!**

Clean your grill often, especially the grease pan and grease cup. Failure to do so may cause a grease fire, resulting in injury or property damage!

### ■ **FOOD SAFETY:**

- Always adhere to the following tips to enjoy a safe and healthy outdoor grilling.
- Always use hot soapy water to wash hands, surfaces & utensils after processing raw meat.
- Always separate the raw meats from done foods to avoid cross contamination
- Always use clean utensils to handle the food.
- Always cook the meat thoroughly to kill germs. If in doubt, use a use a meat thermometer to inspect the inner temperature of the meat.
- Place all foodstuffs promptly into refrigerator once the meal is over, to prevent spoiling.





### 1. **GENERAL:**

- The thickness of the meat will affect the grilling time and results; whether rare, medium, or well done.
- The pre-heated temperature of the grill affects grilling time and results.
- Defrost meat in the refrigerator overnight. Do not use a microwave, as this dries out the meat.
- To get the juiciest meats, use appropriate cooking times and temperatures.
- Cut off any excess fat from the meat before grilling, as this will prevent flame flare ups.
- The hot grids sear the food, caramelizing it for optimal flavor. The longer your grill is the preheated, the faster the meat will sear.

## **!WARNING!**

Do not leave grill unattended while cooking! Potential BURN and FIRE RISK! Do NOT run the rotisserie burner with the main burner.

### 2. **USING THE GRILLING SURFACE (Cook Grids):**

- Grilling requires high heat for searing and proper browning.
- Most foods are cooked at the high  heat setting for the entire cooking time.
- When grilling large pieces of meat or poultry, it may be necessary to turn the heat to a lower setting, after the initial searing. This allows the food to cook through without burning the outside.
- Foods cooked for a long time or basted with a sugary marinade may need a lower heat setting near the end of the cooking time.
- Turn the control knob(s) to high  and preheat the grill for 8 minutes. (Time may vary based on climate)  
Note: Keep the grill closed during preheating.
- Place the food on the grill and cook to the desired doneness. Adjust heat setting, if necessary. The control knobs may be set to any position between  (high) and  (low).

### 3. **USING THE ROTISSERIE KIT:**

- Take off the rotisserie kit (spit rod & forks assembly) from the grill.
- Loosen and slide the left fork off of the spit rod.
- Trim all excess fat from the meat; too much fat can cause a high volume of melted fat to accumulate in the grease tray, resulting in the potential for a grease fire.
- Load the meat or poultry onto the spit rod; center the meat as much as possible.
- Re-install the left fork, and then slide the two forks into the meat to secure.
- Center the forks and meat on the spit rod, then tighten down the fork wing nuts
- If the meat has any loose portions, wrap the meat with butcher's string (never use nylon or plastic )
- Re-install the rotisserie kit into your grill, ensuring that the pointed end is fitted into the motor.



#### 4. TIPS FOR ROTISSERIE COOKING:

- When using the rotisserie, the meat should be centered on the spit rod, after which it must be balanced. To balance the meat, first rotate the cut so that heaviest side is facing downwards.
- Next, position the counter balance so that it faces upwards. Secure in place by tightening the counter balance wing nut. Check the rotisserie function to ensure that the spit is rotating freely. It may be necessary to adjust the counter balance weight in or out, to achieve a smooth rotation.
- Place a drip pan on top of the upper flavor shields and position the pan directly beneath the food on the spit rod. Depending on the flavor you desire, place liquid in the pan such as, water, juices or wine, chop up onions or add garlic, As the juices fall from the meat they will mix with the liquid and evaporate directly into the meat, this removes the need for manual basting as this is a self-basting system.
- Do not let the drip tray dry out.
- You are now ready to rotisserie cook!
- Season meat or poultry as desired, then light the rotisserie burner (refer to instructions in this manual).
- Always use a meat thermometer to determine how well the meat is cooked. Insert the thermometer into the center of the meat. Do not allow the thermometer to touch a bone as this will not give an accurate reading on the meat thermometer. When checking poultry, the best location to insert the thermometer is in the center of the thigh muscle, next to the body.
- Close lid while cooking.

**!WARNING!**  
When cooking fatty meats, check grease levels in the grease pan, in order to prevent a grease fire.

---

## Cleaning and Maintenance:

---

### **CAUTION:**

- Keep the grill area clear and free from combustible materials, gasoline and other flammable vapors and liquids
- Do not obstruct the flow of combustion and ventilation air.
- Keep the ventilation openings of the cylinder enclosure free and clear of debris.
- Ensure that the grill is completely cold before performing any cleaning and maintenance.
- Burning off deposits and soiling by turning the main burners on high for about 5 minutes after each use will keep excessive food residue from building up, but this DOES NOT replace proper cleaning and maintenance.

### **1. GENERAL INFO:**

- This grill is made of stainless steel. There are many different stainless steel cleaners available. Always use the mildest cleaning method first, scrubbing in the direction of the grain.
- To touch up noticeable scratches in the stainless steel, sand very lightly with very fine emery cloth or 800 grit sandpaper, in the direction of the grain. Specks of grease can gather on the surfaces of the stainless steel and bake onto the surface, giving the appearance of rust.
- Use a cleaning pad (such as ScotchBrite) along with a stainless steel cleaner to remove these stains. (Rub in the direction of the stainless grain.) Final finish with a stainless steel polish, using a soft, dry cloth.



**!WARNING!**  
Clean your grease pan & grease cup regularly. Failure to do so may cause a grease fire, resulting in injury or property damage!

## 2. GREASE MANAGEMENT SYSTEM:

- Your grill is equipped with a small grease cup in the back of the unit. This cup should be emptied & cleaned thoroughly after each use and before the grill is transported.
- Your grill is designed to allow grease to flow along the bottom of the firebox, thereby collecting in both the grease pan and the small grease cup.(Fig. 14 & 15).
- Both the grease pan and the cup must be cleaned on a regular basis for the system to work as designed, and prevent grease fires.
- A small amount of sand can be added to the grease pan and cup, to absorb accumulated grease.



Figure 14



Figure 15



## 3. COOKING GRID CLEANING:

- If the grids are heavily soiled, turn your main burners on high for 10 minutes to burn off excess deposits. (Do NOT run the rotisserie burner at this time).
- After each grilling session, clean the cooking grids with a stainless or brass wire barbecue brush. The best method is to clean immediately after cooking, while the grill is still hot. Wear a barbecue mitt to protect your hand from heat and steam. Dip your brush frequently in tap water and scrub the hot grill. Steam created by the hot grill assists the cleaning process by softening deposits. The food particles will fall off and be burn up later. Never immerse ANY hot parts in water.
- For final cleaning, the cooking surface can be washed with hot soapy water, utilizing a Scotch Brite scouring pad for stubborn deposits.

### TECH-TIP

Do NOT turn on the rotisserie burner when the main burners are being used to clean the grill; otherwise overheating damage to your barbecue may result.

### TECH-TIP

Some cleaners may remove the silk screened labels on the console; use caution when cleaning the console.

### TECH-TIP

When cleaning heavy soiling, always polish or scrub in the direction of the stainless steel grain.

## 4. EXTERIOR CLEANING:

- Use mild dish soap and hot water to clean the outside of the grill.
- Do not use any abrasive cleaners, scouring pads, strong degreasers etc., on the exterior of this grill; this will scratch the stainless finish.
- If using the Jackson Stainless Steel Cleaner to remove any surface corrosion be sure to go with the grain of the finish in order to not make swirls in the stainless steel, this product is mildly abrasive and is should be applied with a soft cloth.
- Specks of grease can adhere to the surfaces of the stainless steel and bake on; this will give the appearance of rust. Use an abrasive pad with stainless steel cleaner to remove.
- Sand heavy scratches lightly with 600 grit wet and dry sandpaper.
- Always rinse with clean hot water.
- Use a spray polish (wax) on stainless steel polish to add shine and help protect the exterior stainless steel from surface contaminants and any corrosion.

## 5. INTERIOR CLEANING:

- Remove the cooking grid, flame diffuser and the burner from the grill.
- Remove excess residue using a brush, scraper and/or cleaning pad.
- Spray inside the firebox with oven degreaser and let stand for 5 minutes.
- Use a wire brush to loosen up grease and food residues.
- Wash with soapy water, and rinse with clean hot water, then wipe dry.
- Leave lid open to allow the grill to air dry completely.
- 

### TECH-TIP

Many cleaners can be caustic, so for final cleaning use soapy hot water followed by a rinse with clean hot water.

## 6. MAIN BURNER CLEANING & MAINTENANCE:

- Check to ensure that all gas knobs and valves are off.
- Remove burners and inspect inner and outer surfaces for contamination and debris.
- Clean the exterior burner surface with a stiff stainless steel grill brush.
- Make sure all of the burner port holes are free of obstruction by using a large paperclip to poke the holes out. This is **extremely important** to prolong the lifespan of the stainless steel burner.
- Check inside each burner for insects and insect nest; clean out with a piece of stiff wire.
- Clean mesh air inlets (shutters), at the inlet end of each burner.

## 7. FLAME DIFFUSER MAINTENANCE:

- Remove residue and larger pieces of food using a brush, scraper and or cleaning pad after each use.
- If desired, cleaners can be used for the final cleaning; then rinse with clean hot water.
- This will reduce flare ups and prevent premature break down.

### **!WARNING!**

When reinstalling the main burners after cleaning, the orifices of the valves **MUST** be located in the center of each burner. Failure to do so could cause flames to escape around the burner inlets, which may result in damage or injury.

---

## Casters:

---

- Reduce corrosion on you zinc plated casters by regularly lubricating the swivel raceway bearings, as well as any wheel bearings with grease.
- On the surface of the castor put a protective coating such as a lightweight oil, 3 in 1 oil, or WD40.

---

## Grill Storage:

---

- Clean your grill thoroughly before storage as this will result in greater longevity.
- When propane cylinder is left connected, store the grill outdoors and out of reach of children.
- Store the grill in a dry indoor location **ONLY** after the propane cylinder is turned off and removed.
- All propane cylinder must be stored outdoors, out of the reach of children. **NEVER** store the cylinder in a building, garage or any other enclosed area.
- Disconnect Natural Gas Hose and carefully stow in cart before storing your grill.
- It is best to store your grill with a JLS700 grill cover (sold separately).

# Trouble Shooting:

## A) SPIDER AND INSECT WARNING:

Spiders and insects can nest in burners during storage. This hazard has been known to cause grill fires. Clean the main burners periodically, as well as before storing the grill.

## B) BURNER INSPECTION:

Inspect burners each time you use your grill, or immediately if one of the following occurs:

1. Yellow flames with burnt insect odor.
2. Temperature too low or heats unevenly
3. The burners make popping noises.

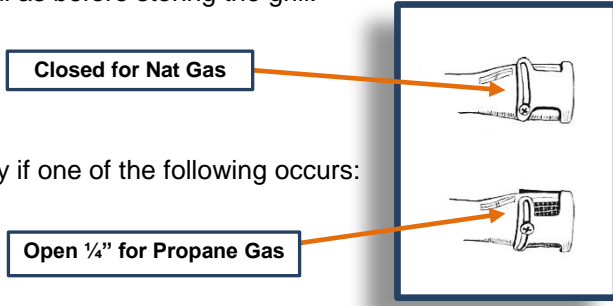

PROBLEMS	POSSIBLE CAUSE	SOLUTIONS
Torch Light pilot flame will not light:	Electrode contaminated w. deposits:	Use an old tooth brush, some alcohol, and emery paper to clean electrode tip and insulator.
	Electrode or wire damaged & no spark:	Replace gas valve assembly complete with wire.
	Electrode wire loose or fallen off:	Reconnect electrode wire at gas valve.
	Plugged Torch Light orifice or outlet tube:	Clean torch tube, and/or unplug orifice with fine wire.
	Natural Gas outlet or propane tank delivering low or no fuel:	Check Nat Gas pressure. Check propane tank empty? Propane Safety Valve tripped (see PP 9).
Main Burner won't light after torchlight lights successfully:	Burner orifices plugged/caked w. residue:	Check and clean burners and main valve orifices.
	Natural Gas outlet or propane tank delivering low or no fuel:	Check Nat Gas pressure. Check propane tank empty? Propane Safety Valve tripped (see PP 9).
	Air Shutters set incorrectly:	Re-set burner air shutters per illustration above
	Burner(s) incorrectly installed and misaligned with valve orifice:	Re-install burner(s) correctly so that the orifice is centered in the burner's inlet.
	Defective Gas Valve(s):	Replace gas valves as needed.
No Spark at rear rotisserie burner:	Dead battery in rear burner ignition switch:	Replace battery by unscrewing switch cap
	Defective ignition switch/module:	Replace ignition switch/module
	Contaminated rotiss burner electrode	Use an old tooth brush, some alcohol, and emery paper to clean electrode tip and insulator.
Inadequate Heat:	Defective regulator	Replace NG Regulator OR Propane Hose & Regulator
	Low inlet Pressure	Check NG gas pressure, check propane tank empty?
	Gas hose bent or kinked:	Smooth out the hose and check for damage
	Grill not preheated:	Preheat the grill for 15 minutes, minimum
Gas valve hard to turn:	Corrosion at valve stem:	Remove knob and lube with penetrating oil; work valve back and forth to loosen; lube regularly.
Excessively yellow or orange flames:	Incomplete combustion:	Re-set burner air shutters per illustration above
Grease Fire or Excessive Flame Flare-ups:	Excess fat on meat causes fat fire flare-ups:	Trim fat off meat before grilling (NOTE: check and empty grease tray regularly)
	Excess Grease deposits:	Regularly clean Firebox, Grease Pan, and Grease Cup NOTE; check grease cup prior to each use of grill.
Flame lifts off burner while in operation:	Gas pressure too high:	Call a professional gas fitter or Propane dealer
	Air Shutters set incorrectly:	Re-set burner air shutters per illustration above
Knobs getting too hot:	Wind blowing from behind the grill:	Reposition grill or create wind barrier.
	Grill is not level:	Reposition grill.

# Exploded View: LUX JLS700

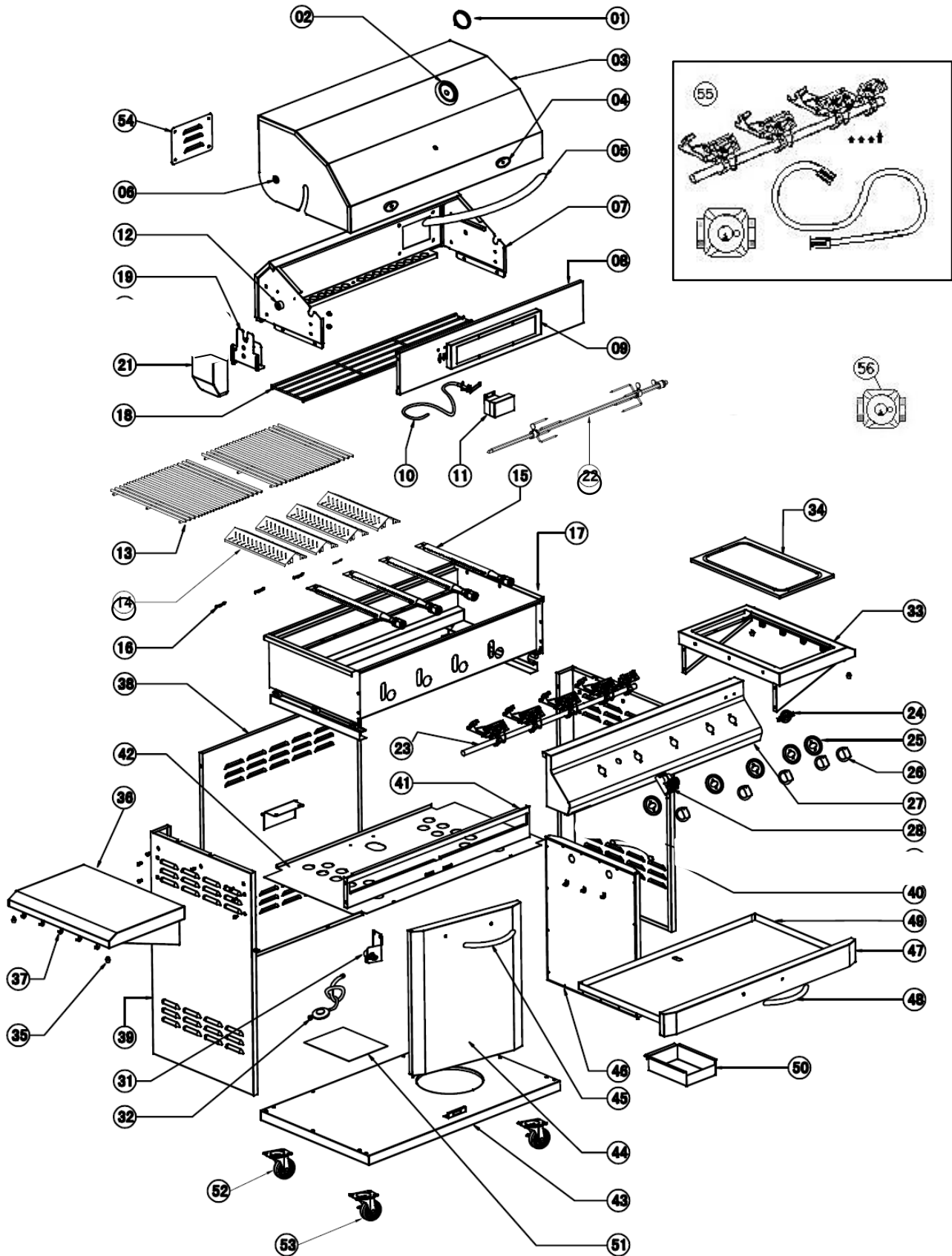

## Parts List: LUX JLS700

Loc.	DESCRIPTION	Part# (Qty.)	Loc.	DESCRIPTION	Part# (Qty.)
01	Thermometer Bezel	JT-11	33	Side Shelf: Right	JC-11
02	Thermometer	JT-10	34	Cutting Board	JC-55
03	Hood	JH-138	36	Side Shelf: Left	JC-10
04	Hood Handle Insulator (Black)	JH-95 (2)	37	Utensil Hooks	n/a
05	Hood Handle	JH-67	38	Pedestal Back	JC-36
06	Hood Spacer & Washer	JH-73 (2)	39	Pedestal Side: Left	JC-38
07	Inner Hood	JH-141	40	Pedestal Side: Right	JC-37
08	Rotisserie Burner Mount	JH-16	41	Horizontal Frame; Cart	JC-69
09	Rotisserie Burner	JB-15	42	Pedestal Heat Shield	JC-59
10	Rotisserie Burner Electrode	JE-19	43	Pedestal Base	JC-34
11	Rotiss. Electrode Collector	JH-26	44	Pedestal Door: Left	JC-76
12	Hood Spacer (see #6 above)	n/a	45	L & R Door Handle (See #48)	JC-105 (2)
13	Cooking Grid	JG-53 (2)	46	Pedestal Door: Right	JC-75
14	Flame Diffusers	JD-06 (4)	47	Grease Pan w/Handle	JH-47
15	Main Burners	JB-00 (4)	48	Grease Pan Handle	JC-60
16	Burner Cotter Pin	JB-50 (4)	48	Hood Bushing & Spacer Kit	JH-73 (2)
17	Firebox (Tub)	JH-57	50	Grease Cup	JH-83
18	Warming Rack	JG-48	51	Pedestal Base Access Cover	JC-65
19	Rotisserie Motor Bracket	JR-10	52	Swivel Caster (NON-Locking: Rear)	JC-89
21	Rotisserie Motor	JR-05	53	Swivel Caster (Locking: Front)	JC-88
22	Rotisserie Spit Rod	JR-55	54	Rotisserie Orifice Access Cover	JH-69
23a	Manifold Assembly (Propane)	JF-53	55a	Nat Gas Conversion Kit (option)	JF-74
23b	Manifold Assembly (Nat Gas)	JF-77	55b	Propane Conversion Kit (option)	JF-113
24	Jackson Logo Badge	JH-02	56	4" Natural Gas Regulator	JF-99
25	Chrome Bezel for knobs	JK-20 (5)	n/a	*Rotisserie Balancer	JR-34
26	Knob (New: Black & Chrome)	JK-14 (5)	n/a	*Rotiss Ignition Module Heat Shield	JH-132
27	Control Panel Assy. (Console)	JH-130	n/a	*Hood Rubber Bumpers	JH-00 (2)
28	Rotisserie Ignition Module	JE-03	n/a	*Rotisserie Fork Kit	JR-17
31	Gas Manifold Bracket	JF-54	n/a	*Natural Gas Hose w. quick release	NGHOSE
32	Hose & Regulator; Propane	JF-70		<b>* NOT SHOWN</b>	

---

# Limited Lifetime Warranty:

---

## MODEL NO: LUX JLS700-LP & JLS700-NG Cart Type

Jackson Grills warrants the following materials and workmanship to be free of defects for as long as you own the grill subject to the conditions below:

**10 year plus 5 Warranty:** (from date of purchase); Jackson Grills will replace (at our option), any defective stainless steel burner for the first 10 years. From 11-15 years, Jackson Grills will provide 50% of the current retail price of the stainless steel burner.

**First 5 years:** (from date of purchase); Jackson Grills will replace or repair (at our option), any defective part in the list below, at no charge. From year 6 to lifetime, any defective part in the list below will be replaced or repaired (at our option) at 50% of the current retail price:

- Stainless steel inner & outer hood
- Warming Shelf
- Outer pedestal system
- Stainless steel handle
- Firebox
- Flame diffusers
- Stainless steel cooking grids

**2 Year Warranty:** (from date of purchase); Jackson Grills will replace or repair (at our option), any defective part from the list below, at no charge.

- Warming Shelf
- LP hose and regulator
- Natural Gas Hose & Quick Release fitting
- Natural Gas Regulator
- Thermometer
- Gas valves
- Knobs & fasteners
- Igniter and electrode
- Accessory parts (excluding covers)
- Casters

## Limited Warranty Subject to the following Conditions & Limitations:

(NOTE: Shipping and Labor Charges are NOT covered)

- The bill of sale (proof of original ownership) and serial number will be required in order to claim warranty from your authorized dealer. The warranty registration card must be returned within 30 days to register your warranty.
- This factory warranty is non-transferable and may not be extended under any circumstances.
- Jackson Grills warrants its products to the original purchaser only (NO EXCEPTIONS)
- This Limited Warranty does not cover any damage caused by misuse, lack of maintenance, hostile environments, accident, alterations, abuse or neglect, including scratches, dents, corrosion, discoloring by heat ( discoloring is normal), & abrasive or chemical damage resulting from use of harsh cleaners.
- Should deterioration occur to the point of non-performance within the duration of the warranted coverage, a replacement will be provided in the first year only. This warranty extends to the repair or replacement of warranted parts that are defective in materials or workmanship provided that the product has been operated in accordance with the operation instructions and under normal conditions.
- After the first year Jackson Grills reserves the right to fully disengage all obligations of this Warranty by refunding the original warranted purchaser the original wholesale price of the warranted parts
- A licensed, authorized, service technician or contractor must install the gas grill.
- Genuine Jackson parts must always be used; use of parts supplied by other manufacturers will nullify the warranty.
- The installation must be done in accordance with the installation procedures described in the included owner's manual.
- Jackson Grills or its parties will not be responsible for the installation, labor or any other costs or expenses related to the refitting of the warranted part, and such expenses are not covered by this warranty.
- Notwithstanding any provision contained in this Limited Warranty, Jackson Grills responsibility under this warranty is defined as above and it shall not in any event extend to any incidental, consequential, or indirect damages.
- Jackson Grills neither assumes, nor authorizes any third party to assume, on its behalf, any other liabilities with respect to the sale of this product.
- Jackson Grills reserves the right to inspect any parts prior to approving warranty claim.
- Jackson Grills or its representatives shall not be liable for ANY expenses arising from labor, shipping, or customs duty costs.