



ENGLISH

ESPAÑOL

OWNER'S MANUAL

WASHING MACHINE

Please read this owner's manual thoroughly before operating the appliance and keep it handy for reference at all times.

WT7600H*A



MFL39760288
ver.072016.04

www.lg.com

TABLE OF CONTENTS

3	IMPORTANT SAFETY INSTRUCTIONS	
3	Basic Safety Precautions	26 - Water Plus
4	Grounding Requirements	26 - Signal
5	Safety Instructions For Installation	26 - Child Lock
6	Safety Instructions For Use, Care, Cleaning And Disposal	26 - Add Garments
7	FEATURES AND BENEFITS	
7	Key Parts and Components	
7	Included Accessories	
8	INSTALLATION INSTRUCTIONS	
8	Choose the Proper Location	
8	Power Outlet	
8	Flooring	
9	Unpacking and Removing Shipping Material	
10	Connecting the Water Lines	
11	Connecting the Drain Hose	
12	Leveling the Washer	
13	Connect to The Power Supply	
13	PREPARATION	
13	Sorting Wash Loads	
14	Loading the Washer	
15	About the Dispensers	
15	Detergent and Dispenser Use	
17	HOW TO USE	
17	Control Panel Features	
18	Time and Status Display	
19	Operating the Washer	
20	Cycle Guide	
22	Wash Cycles	
23	Cycle Modifier Buttons	
24	Special Care Features	
25	Option Buttons	
25	-Steam	
25	-Cold Wash™	
25	- Delay Wash	
25	- Custom Program(PGM)	
25	- Turbo Wash™	
26	- Fabric Softener	
26	- Extra Rinse	
27	CARE AND CLEANING	
27	Regular Cleaning	
27	- Cleaning the Exterior	
27	- Care and Cleaning of the Interior	
27	- Tub Clean Cycle	
27	- Removing Mineral Buildup	
27	- Leave the Lid Open	
28	Maintenance	
29	Cleaning the Washer	
30	SPECIFICATIONS	
30	SMART DIAGNOSIS™ SYSTEM	
31	TAG ON FUNCTION	
31	Before Using Tag On	
33	Using Tag On	
42	TROUBLESHOOTING	
42	Normal Sounds You May Hear	
42	Before Calling for Service	
46	Error Codes	
48	WARRANTY	

IMPORTANT SAFETY INSTRUCTIONS



SAFETY MESSAGES

For your safety, the information in this manual must be followed to minimize the risk of fire or explosion, electric shock, or to prevent property damage, injury to persons, or death. Your safety and the safety of others is very important. There are many important safety messages in this manual and on your appliance. Always read and obey all safety messages.



This is the safety alert symbol. This symbol alerts you to potential hazards that can result in property damage and/or serious bodily harm or death.

All safety messages will follow the safety alert symbol and either the word DANGER, WARNING or CAUTION. These words mean:

-  **DANGER** You will be killed or seriously injured if you don't immediately follow instructions.
-  **WARNING** You can be killed or seriously injured if you don't follow instructions.
-  **CAUTION** You may be slightly injured or cause damage to the product if you do not follow instructions.

All safety messages will tell you what the potential hazard is, tell you how to reduce the chance of injury, and tell you what can happen if the instructions are not followed.

BASIC SAFETY PRECAUTIONS

WARNING

To reduce the risk of fire, electric shock, or injury to persons when using this appliance, follow basic precautions, including the following.

- Use this appliance only for its intended purpose as described in this owner's Manual.
- **Before use, the washer must be properly installed as described in this manual.**
- **Do not wash articles that have been previously cleaned in, washed in, soaked in, or spotted with gasoline, dry cleaning solvents, or other flammable or explosive substances, as they give off vapors that could ignite or explode.**
- **Do not add gasoline, dry cleaning solvents, or other flammable or explosive substances to the wash water.** These substances give off vapors that could ignite or explode.
- Under certain conditions, hydrogen gas may be produced in a hot water system that has not been used for 2 weeks or more. **HYDROGEN GAS IS EXPLOSIVE. If the hot water system has not been used for such a period, before using the washer, turn on all hot water faucets and let the water flow from each for several minutes.** This will release any accumulated hydrogen gas. As the gas is flammable, **do not smoke or use an open flame during this time.**
- **Do not allow children to play on or in the washer.** Close supervision of children is necessary when the washer is used near children.
- **Before the washer is removed from service or discarded, remove the lid to prevent children from climbing inside.**
- **Do not install or store the washer where it will be exposed to the weather or freezing temperatures.**
- **Do not tamper with controls.**
- Keep the area underneath and around your appliances free of combustible materials (lint, paper, rags, etc.), gasoline, chemicals and other flammable vapors and liquids.
- Service must be performed by a qualified service technician. **Do not disassemble the washer.**
- **See Installation Instructions for grounding requirements.**
- **WARNING :** This product contains chemicals known to the State of California to cause cancer and birth defects or other reproductive harm. **Wash hands after handling.**

- **ALWAYS follow the fabric care instructions supplied by the garment manufacturer.**
- **Do not place items exposed to cooking oil in your washer.** Items contaminated with cooking oils may contribute to a chemical reaction that could cause a load to catch fire.
- **Use fabric softeners or products to eliminate static only as recommended by the manufacturer.**
- This washer is not designed for maritime use or for mobile installations such as in RVs, aircraft, etc.
- **Turn off the water faucets and unplug the washer if the machine is to be left for an extended period of time, such as during vacations.**
- **Do not use to dry articles containing foam rubber or similarly textured rubber-like materials.**
- Packaging material can be dangerous for children. There is a risk of suffocation! Keep all packaging from children.
- **Always check the inside of the washer for foreign objects before loading laundry. Keep the lid closed when not in use.**
- **Do not reach into the appliance if the tub or agitator is moving.**

READ ALL INSTRUCTIONS BEFORE USE

WARNING

For your safety, the information in this manual must be followed to minimize the risk of fire or explosion, electric shock, or to prevent property damage, injury to persons, or death.

GROUNDING REQUIREMENTS

This appliance must be grounded. In the event of malfunction or breakdown, grounding will reduce the risk of electric shock by providing a path of least resistance for electric current. This appliance is equipped with a cord having an equipment-grounding conductor and grounding plug. The plug must be plugged into an appropriate outlet that is properly installed and grounded in accordance with all local codes and ordinances.

WARNING

Improper connection of the equipment-grounding conductor can result in risk of electric shock. Check with a qualified electrician or servicer if you are in doubt as to whether the appliance is properly grounded. Do not modify the plug provided with the appliance. If it does not fit the outlet, have a proper outlet installed by a qualified electrician. Failure to follow these warnings can cause serious injury, fire, electric shock, or death.

⚠ WARNING

For your safety, the information in this manual must be followed to minimize the risk of fire or explosion, electric shock, or to prevent property damage, injury to persons, or death.

SAFETY INSTRUCTIONS FOR INSTALLATION**⚠ WARNING**

To reduce the risk of fire, electric shock or injury to persons when using this appliance, follow basic precautions, including the following:

- **Refer to INSTALLATION INSTRUCTIONS for detailed grounding procedures.** Installation instructions are packed with the washer for installer's reference. If the washer is moved to a new location, have it checked and reinstalled by a qualified service technician. Failure to follow this warning can cause serious injury, fire, electric shock, or death.
- **Do not, under any circumstances, cut or remove the third (ground) prong from the power cord.** Failure to follow this warning can cause serious injury, fire, electric shock, or death.
- **For personal safety, this appliance must be properly grounded.** Failure to follow this warning can cause serious injury, fire, electric shock, or death.
- **The power cord of this appliance is equipped with a 3-prong (grounding) plug which mates with a standard 3-prong (grounding) wall outlet** to minimize the possibility of electric shock from this appliance.
- **This washer must be plugged into a 120 VAC, 60 Hz grounded outlet.** Failure to follow this warning can cause serious injury, fire, electric shock, or death.
- **Have the wall outlet and circuit checked by a qualified electrician to make sure the outlet is properly grounded.** Failure to follow this warning can cause serious injury, fire, electric shock, or death.
- **Where a standard 2-prong wall outlet is encountered, it is your personal responsibility and obligation to have it replaced with a properly grounded 3-prong wall outlet.** Failure to follow this warning can cause serious injury, fire, electric shock, or death.
- **Do not install on carpet. Install washer on a solid floor.** Failure to follow this warning can cause serious leak damage.
- **Do not remove ground prong. Do not use an adapter or extension cord. Plug into a grounded 3-prong outlet.** Failure to follow these warnings can cause serious injury, fire, electric shock, or death.
- **The washer should always be plugged into its own individual electrical outlet which has a voltage rating that matches the rating plate.** This provides the best performance and also prevents overloading house wiring circuits which could cause a fire hazard from overheated wires.
- **Never unplug your washer by pulling on the power cord.** Always grip plug firmly and pull straight out from the outlet. Failure to follow this warning can cause serious injury, fire, electric shock, or death.
- **Repair or immediately replace all power cords that have become frayed or otherwise damaged. Do not use a cord that shows cracks or abrasion damage along its length or at either end.** Failure to follow this warning can cause serious injury, fire, electric shock, or death.
- **When installing or moving the washer, be careful not to pinch, crush, or damage the power cord.** Failure to follow this warning can cause serious injury, fire, electric shock, or death.
- **The washer must be installed and electrically grounded by a qualified service person in accordance with local codes** to prevent shock hazard and assure stability during operation.
- **The washer is heavy. Two or more people may be needed to install and move the appliance.** Failure to do so can result in back or other injury.
- **Store and install the washer where it will not be exposed to temperatures below freezing or exposed to outdoor weather conditions.** Failure to follow this warning can cause serious leak damage.
- **Do not install the washer in humid spaces to reduce the risk of electric shock.** Failure to follow this warning can cause serious injury, fire, electric shock, or death.
- **To reduce the risk of injury to persons, adhere to all industry recommended safety procedures including the use of long sleeved gloves and safety glasses.** Failure to follow all of the safety warnings in this manual could result in property damage, injury to persons or death.
- Never attempt to operate this appliance if it is damaged, malfunctioning, partially disassembled, or has missing or broken parts, including a damaged cord or plug.
- To minimize the possibility of electric shock, unplug this appliance from the power supply or disconnect the washer at the household distribution panel by removing the fuse or switching off the circuit breaker before attempting any maintenance or cleaning.

⚠ WARNING

For your safety, the information in this manual must be followed to minimize the risk of fire or explosion, electric shock, or to prevent property damage, injury to persons, or death.

SAFETY INSTRUCTIONS FOR USE, CARE, CLEANING AND DISPOSAL**⚠ WARNING**

To reduce the risk of fire, electric shock or injury to persons when using this appliance, follow basic precautions, including the following:

- **Unplug the washer before cleaning** to avoid the risk of electric shock.
- **Never use harsh chemicals, abrasive cleaners, or solvents to clean the washer.** They will damage the finish.
- **Do not put oily or greasy rags or clothing on top of the washer.** These substances give off vapors that could ignite the materials.
- **Do not wash items that are soiled with vegetable or cooking oil.** These items may contain some oil after laundering. Due to the remaining oil, the fabric may smoke or catch fire by itself.
- **Disconnect this appliance from the power supply before attempting any user maintenance.** Turning the controls to the OFF position does not disconnect this appliance from the power supply. Failure to follow this warning can cause serious injury, fire, electric shock, or death.
- **Do not combine laundry products for use in one load unless specified on the label.**
- **Do not mix chlorine bleach with ammonia or acids such as vinegar.** Follow package directions when using laundry products. Incorrect usage can produce poisonous gas, resulting in serious injury or death.
- **Do not reach into the washer while parts are moving.** Before loading, unloading, or adding items, press the START/PAUSE button and allow the drum to coast to a complete stop before reaching inside. Failure to follow this warning can cause serious injury, fire, electric shock, or death.
- **Do not allow children to play on or in the washer.** Close supervision of children is necessary when the washer is used near children. As children grow, teach them the proper, safe use of all appliances. Failure to comply with these warnings could result in serious injury to persons or death.
- **Destroy the carton, plastic bag, and other packing materials after the washer is unpacked.** Children might use them for play. Cartons covered with rugs, bedspreads, or plastic sheets can become airtight chambers. Failure to comply with these warnings could result in serious injury to persons or death.
- **Keep laundry products out of children's reach.** To prevent injury to persons, observe all warnings on product labels. Failure to comply with these warnings could result in serious injury to persons or death.
- **Remove the lid to the washing compartment to avoid the danger of children or small animals getting trapped inside before your washer is removed from service or discarded.** Failure to do so can result in serious injury to persons or death.
- **Keep hands and foreign objects clear of the lid and latch area when closing the lid.** Failure to keep hands clear can result in personal injury.

SAVE THESE INSTRUCTIONS

ENGLISH

FEATURES AND BENEFITS
KEY PARTS AND COMPONENTS

- A INVERTER DIRECT DRIVE MOTOR**
The inverter motor, which is directly connected to the tub, produces little noise and vibration and offers great durability and long lifespan.
- B ULTRA CAPACITY & NEVERUST™ STAINLESS STEEL TUB**
The efficient design provides you with ultra large capacity but without making the cabinet larger or the drum any deeper for easy installation and use.
- C TURBO WASH™**
Turbo Wash™ reduces wash time without compromising performance. The precise drum movements and powerful water jets allow for faster soaking, while the Smart Rinse™ Jet Spray allows for quicker rinsing, saving you up to 20 minutes per load without sacrificing washing performance.
- D ALLERGIENE™**
This powerful, high-temperature steam cycle is designed to reduce up to 95 percent of common household allergens such as dust mites and pet dander, and is certified by the Asthma and Allergy Foundation of America (AAFA).
- E REAR TOUCH PANEL**
The easy to read LED display shows cycle options, setting, cycle status and estimated time remaining. The touch buttons offer more convenience and a premium design aesthetic.
- F SLAM PROOF™ LID**
The Slam Proof™ lid is a safety device that closes the lid slowly. The Slam Proof™ hinges allow the lid to close gently and quietly, helping prevent injuries.
- G SMART DIAGNOSIS™**
If you ever experience an issue with your LG washer, you don't have to worry. The SmartDiagnosis™ feature helps the service center diagnose problems over the phone, or with a simple app on your smart phone, helping you minimize costly, inconvenient service calls.

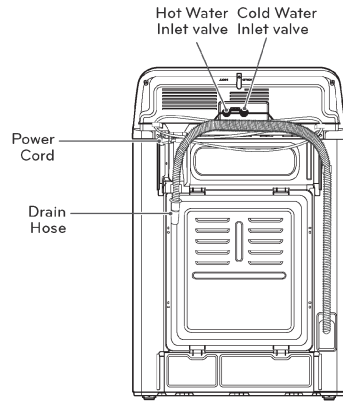
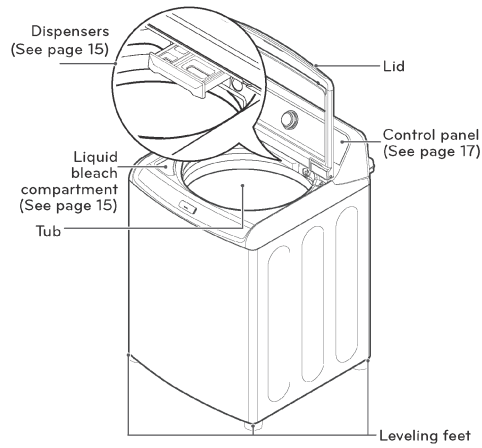

INCLUDED ACCESSORY

- Tie Strap (for securing drain hose)



REQUIRED ACCESSORY (sold separately)

- Required accessory is sold separately. It can be ordered through LG Website. US: www.lg.com/us
- Hot/cold water hoses
- Part Number**
- 5215FD3715U : Hot water hose
- 5215FD3715V : Cold water hose

INSTALLATION INSTRUCTIONS

CHOOSE THE PROPER LOCATION

⚠ WARNING

- The washer is heavy. Two or more people are required when moving and unpacking the washer. Failure to do so may result in damage to property or serious bodily harm.
- Store and install the washer where it will not be exposed to temperatures below freezing or exposed to outdoor weather conditions. Failure to follow this warning can cause serious injury, fire, electric shock, or death.
- Properly ground washer to conform with all electric governing codes and ordinances. Failure to follow this warning can cause serious injury, fire, electric shock, or death.
- To reduce the risk of electric shock, do not install the washer in humid spaces. Failure to follow this warning can cause serious injury, fire, electric shock, or death.
- To ensure proper air flow, do not block the large opening on the bottom of the washer with carpeting or other materials.
- Do not remove ground prong. Do not use an adapter or extension cord. Plug into a grounded 3-prong outlet. Failure to follow this warning can cause serious injury, fire, electric shock, or death.

POWER OUTLET

- The power outlet must be within 60 in. (1.5 m) of either side of the washer.
- The appliance and outlet must be positioned so that the plug is easily accessible.
- Do not overload the outlet with more than one appliance.
- The outlet must be grounded in accordance with current wiring electric codes and regulations.
- Time-delay fuse or circuit breaker is recommended.

NOTE: It is the personal responsibility and obligation of the product owner to have a proper outlet installed by a qualified service technician.

FLOORING

- To minimize noise and vibration, the washer MUST be installed on a solidly constructed floor.
- Allowable slope under the entire washer is a maximum 1 in. difference from side to side or from front to back.
- Installing on carpeting and soft tile surfaces is not recommended.
- Never install the washer on a platform or weakly supported structure.

NOTE: The washer must be installed on firm flooring to minimize vibration during the spin cycle. Concrete flooring is best, but a wood floor is sufficient, provided it is built to FHA standards. The washer should not be installed on rugs or exposed to weather.

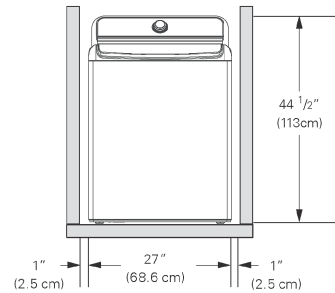

To ensure sufficient clearance for water lines and airflow, allow minimum clearances of at least 1 in. (2.5 cm) at the sides and 4 in. (10 cm) behind the unit. Be sure to allow for wall, door, or floor moldings that may increase the required clearances.

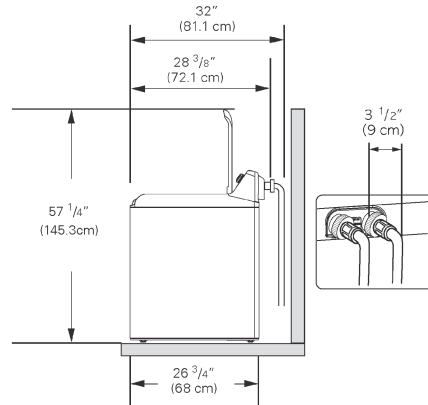

Minimum vertical space from floor to overhead shelves, cabinets, ceilings, etc., is 56 in.

UNPACKING AND REMOVING SHIPPING MATERIAL

1. After removing the carton and shipping material, lift the washer off the foam base. Make sure the plastic tub support comes off with the base and is not stuck to the bottom of the washer.

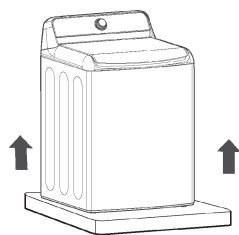

If you must lay the washer down to remove the base packaging materials, always protect the side of the washer and lay it carefully on its side. DO NOT lay the washer on its front or back.

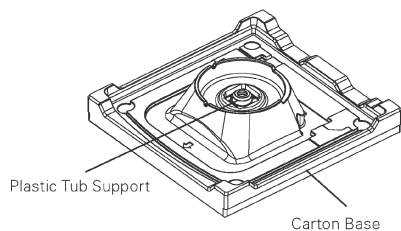

2. Save the foam block (that contains the Owner's Manual, parts and laundry product samples) for future use. If the washer must be moved in the future, the foam block will help prevent damage to the washer during transportation.

NOTE: To prevent damage, do not remove the foam block until the washer is at the final location.

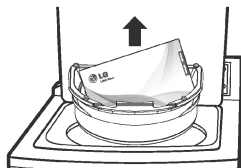

3. Unfasten the power cord from the back of the washer.

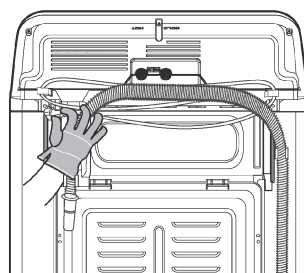

TOOLS YOU WILL NEED

- Adjustable Pliers

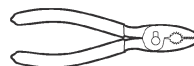

- Carpenter's Level



CONNECTING THE WATER LINES

- For your safety, and for extended product life, we recommend using high-quality LG components. LG is not responsible for product malfunction or damage caused by the use of separately purchased non-LG parts.
- Use new hoses when installing the washing machine. Do not reuse old hoses.
- Contact LG Customer Service for assistance in buying hoses: 1-800-243-0000.
- Water supply pressure must be between 20 psi and 120 psi (138–827 kPa). If the water supply pressure is more than 120 psi, a pressure reducing valve must be installed.
- Periodically check the hose for cracks, leaks, and wear, and replace the hoses every 5 years.
- Make sure that the water lines are not stretched, pinched, crushed, or kinked.
- The washer should never be installed or stored in a location subject to freezing temperatures. Damage to the water lines and internal mechanisms of the washer can result. If the washer was exposed to freezing temperatures prior to installation, allow it to stand at room temperature for several hours before use and check for leaks prior to operation.

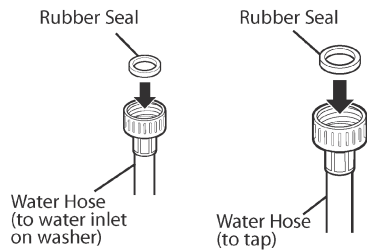

1. Inspect the threaded fitting on each hose and make sure there is a rubber seal in place in both ends.

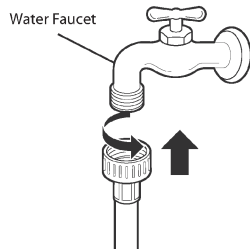

⚠️ WARNING

- **Do not reuse old hoses.** Only use new hoses when you install the washing machine. Old hoses could leak or burst causing flooding and property damage.

2. Connect the water supply hoses to the HOT and COLD water faucets tightly by hand and then tighten another 2/3 turn with pliers.

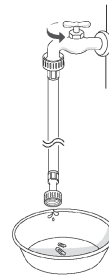

⚠️ WARNING

- **Do not overtighten.** Damage to the coupling can result.

3. Always run a gallon or two of water through each inlet hose to flush dirt, scale and other debris out of the water lines. Doing so will help prevent future problems with clogged filter screens, and will also allow you to verify which hose is hot and which is cold.

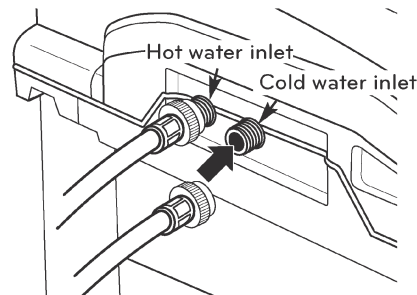

⚠️ WARNING

- **Do not overtighten the hoses.** Overtightening can damage the valves resulting in leaking and property damage.

4. Attach the hot water line to the hot water inlet on the back of the washer. Attach the cold water line to the cold water inlet on the back of the washer. Tighten the fittings securely. Turn ON both faucets all the way and check for leaks at both ends of the hoses.

NOTE: Be careful not to cross-thread the hose fittings. This will damage the valve and could result in property damage from leaks.

CONNECTING THE DRAIN HOSE

- The drain hose should always be properly secured. Failure to properly secure the drain hose can result in flooding and property damage.
- The drain must be installed in accordance with any applicable local codes and regulations.
- Make sure that the drain hose is not stretched, pinched, crushed, or kinked.

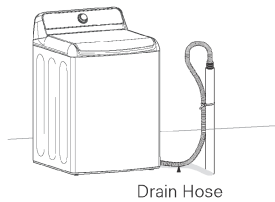

OPTION 2: LAUNDRY TUB

Bend the end of the drain hose to the desired shape and support it on the edge of the laundry tub. Use the tie strap to secure the drain hose in place.

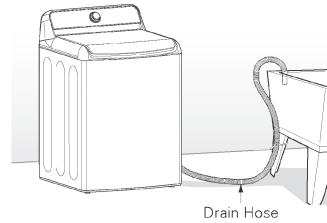

OPTION 1: STANDPIPE

Bend the outlet end of the drain hose to form a U shape. Insert the end of the drain hose into the drain. If the drain is large enough for the flange on the hose to fit inside, then do not insert the flange more than 1-2 inches into the drain. Use the tie strap included with the installation materials in the foam block in the tub to secure the drain hose to the drain.

If the water valves and drain are built into the wall, fasten the drain hose to one of the water hoses with the tie strap (ribbed side on inside).

If your drain is a standpipe, fasten the drain hose to the standpipe with the tie strap provided.

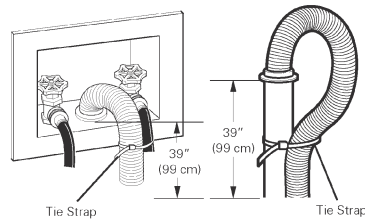

NOTE:

- Normal height of the end of the hose should be approximately 35"~47" (0.9~1.2 m) from the floor.
- Do not install the end of the drain hose lower than 29 in. (73.7 cm) or higher than 96 in. (243.8 cm) above the bottom of the washer or more than 60 in. (152.4 cm) away from the washer.
- Never create an air-tight seal between the drain hose and the drain, using tape or other methods. If no air gap is present, water can be siphoned out of the tub resulting in poor wash/rinse performance or clothing damage.

LEVELING THE WASHER

The tub of your new washer spins at very high speeds. To minimize vibration, noise, and unwanted movement, the floor must be a level, solid surface.

NOTE:

- Adjust the leveling feet only as far as necessary to level the washer. Extending the leveling feet more than necessary can cause the washer to vibrate.
- Before installing the washer, make sure that the floor is clean, dry and free of dust, dirt, water and oils so the washer feet cannot slide easily. Leveling feet that move or slide on the floor can contribute to excessive vibration and noise due to poor contact with the floor.

All four leveling feet must rest solidly on the floor. Attempt to rock the washer from corner to corner to make sure that all four leveling feet are in firm contact with the floor.

1. Position the washer in its final location, taking special care not to pinch, strain, or crush the water and drain lines. Place a level across the top of the washer.

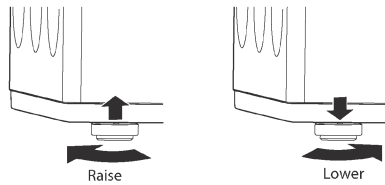

2. Adjust the leveling feet. Turn clockwise to raise the washer or counterclockwise to lower it.

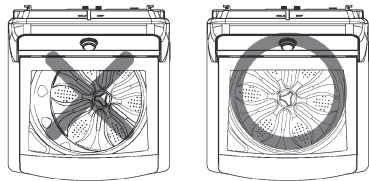

3. To make sure that the washer is properly level, open the lid and look from above to see if the tub is centered. If the tub is NOT centered (as shown in the drawing with the X through it), readjust the front feet. If you have a level, check your washer with the level.

- To check if the washer is level from side to side, place a level on the back edge of the lid.
- To check if the washer is level front to back, place a level at the side of the washer on the edge where

the cabinet side meets the top cover. Do not place the level on the top of the lid. Using these surfaces will result in the washer being unlevel.

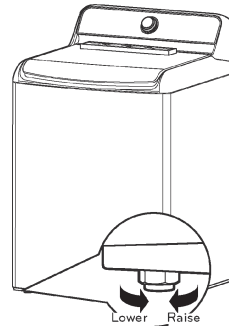

⚠ WARNING

- Using the washing machine without leveling, it may result in malfunction caused by the production of excess vibration and noise.
- **Use the leveling feet only when you level the washing machine.** If you raise the leveling feet unnecessarily, it may cause abnormal vibration of the washing machine.

CONNECT TO THE POWER SUPPLY

The washer should be plugged into a 120-VAC, 60-Hz grounded 3-prong outlet. Plug in the washer. Improper connection of the equipment-grounding conductor can result in risk of electric shock. Check with a qualified electrician or service technician if you are in doubt as to whether the appliance is properly grounded. Do not modify the plug provided with the appliance. If it does not fit the outlet, have a proper outlet installed by a qualified electrician. Failure to follow these warnings can cause serious injury, fire, electrical shock, or death.

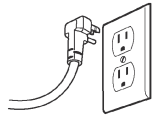

⚠️ WARNING

- The power outlet must be within 60 inches (1.5 m) of either side of the washer.
- The appliance and outlet must be positioned so that the plug is easily accessible.
- Do not overload the outlet with more than one appliance.
- The outlet must be grounded in accordance with current wiring codes and regulations.
- Time-delay fuse or circuit breaker is recommended.
- It is the personal responsibility and obligation of the product owner to have a proper outlet installed by a qualified electrician.
- Do not use a worn or damaged power cord or power plug. Replace or repair it immediately. Failure to do so may result in death, fire, electric shock, or malfunction.
- Do not modify the power cord and take care not to damage it when installing or moving the washing machine. Failure to do so may result in death, fire, electric shock, or malfunction.
- Make sure that the washing machine is grounded.
- Connect this washing machine to a grounded outlet conforming to the rating prior to use. Failure to do so may result in fire, electric shock, or malfunction.
- Do not use adaptors or extension cords. The washing machine should always be plugged into its own individual electrical outlet which has a voltage rating that matches the rating plate. Failure to do so may result in fire, electric shock or disorder.
- Do not damage or cut off the ground prong of the power cord. Doing so may cause death, fire, electric shock, or product malfunction.

PREPARATION

SORTING WASH LOADS

⚠️ CAUTION

- Do not load items higher than the top edge of the tub. Failure to follow this caution can result in leakage or damage to fabrics.
- Use the Bedding cycle for buoyant or nonabsorbent items such as pillows or comforters. Failure to follow this caution can result in leakage.
- If possible, do not wash any water-resistant items. If you must, please select the Waterproof cycle. (i.e. Water resistant clothing, mattress covers, outdoor clothes, plastic mats etc.)
- If waterproof material laundry is washed in a course other than Waterproof, it may result in injury or damage to the washer, clothes, walls, floor, and surrounding objects due to abnormal vibration.

GROUPING SIMILAR ITEMS

For the best washing results, and to reduce the possibility of damage to clothing, care should be taken to sort the clothing into loads that are made up of similar items.

Mixing different fabric types and/or soil levels can result in poor wash performance, color transfer, discoloration, fabric damage or linting. Fabrics should be sorted into groups as described below.

COLORS

Sort articles by color. Wash dark clothes together in a separate load from light colors or whites. Mixing dark clothes with light clothes can result in dye transfer or discoloration of the lighter clothes.

SOIL LEVEL

Wash heavily soiled clothing together. Washing lightly soiled clothing in the same load with heavily soiled clothing could result in poor wash performance for the lightly soiled clothing.

FABRIC TYPE

Delicate articles should not be mixed with heavier or sturdier fabric types. Washing heavier fabrics in a delicate load can result in poor wash performance for the heavier fabrics and possible damage to the delicates.

LINT TYPE

Some fabrics attract and bind lint to them while others give off lint in the laundry process. Avoid mixing these lint collectors and lint producers in the same load. Mixing these fabrics will result in pilling and linting on the lint collectors. (For example, lint collector – knit sweater; lint producer – terry cloth towels.)

SORT LAUNDRY...

By Colors	By Soil	By Fabric	By Lint
White	Heavy	Delicates	Lint Producer
Lights	Normal	Easy Care	Line Collector
Darks	Light	Sturdy	

FABRIC CARE LABELS

Many articles of clothing include a fabric care label. Using the chart below, adjust the cycle and option selections to care for your clothing according to the manufacturer's recommendations.

Fabric Care Labels			
Machine wash cycle			
	Normal	Permanent press/wrinkle resistant	Gentle/delicate
	Hand wash	Do not wash	Do not wring
Water temperature			
	Hot	Warm	Cold/cool
	Any bleach (when needed)	Only non-chlorine bleach (when needed)	Do not bleach

LOADING THE WASHER



- Check all pockets to make sure that they are empty. Items such as clips, matches, pens, coins, and keys can damage both your washer and your clothes.
- Close zippers, hooks, and drawstrings to prevent these items from snagging or tangling on other clothes.
- Pretreat heavily stained areas for best results.
- Combine large and small items in a load. Load large items first.
- Large items should not be more than half of the total wash load.
- The washer can be fully loaded, but the tub should not be tightly packed with items. The lid of the washer should close easily.
- To prevent an out-of-balance load, do not wash single items. Add one or two similar items to the load. Large, bulky items, such as a blanket, comforter, or bedspread, should be washed individually.
- Waterproof items do wash or spin Waterproof cycle. (i.e. Water resistant clothing, mattress covers, outdoor clothes, plastic mats etc.)
- The washer will not fill or operate with the lid open.

1. For best performance, load clothes as shown.

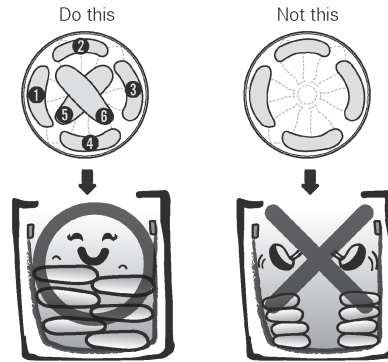

2. Load clothes loosely, and do not load clothes over the maximum guideline on the tub. Clothes need room to circulate in order to get clean.

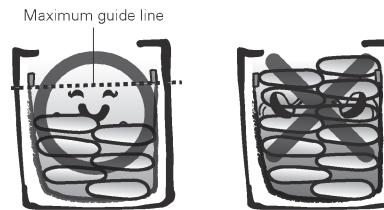

NOTE: Use the Bedding cycle for large or bulky items such as poly-filled jackets, comforters, pillows, etc. These items may not be as absorbent as other laundry items and should be sorted into a separate wash load for optimal results.

Bulky items should be placed as far down in the tub as possible for optimal results. Always place buoyant items at the bottom of the tub. The washer will automatically detect the load size. Because of the high-efficiency wash system, the water level may not completely cover the load.

ABOUT THE DISPENSERS

The automatic dispenser consists of two compartments which hold:

- Liquid fabric softener.
- Liquid or powdered detergent for main wash.

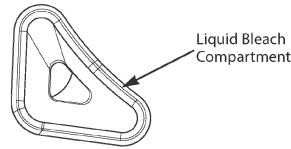
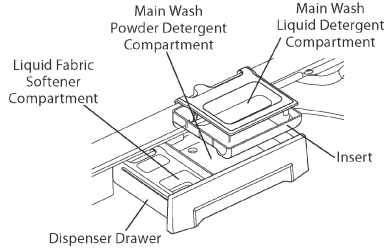

LIQUID BLEACH COMPARTMENT

The bleach dispenser is a separate compartment at the left front of the tub opening. This compartment holds liquid bleach, which is dispensed automatically at the proper time during the wash cycle. The dispenser is activated twice to ensure complete dispensing of the bleach. Any liquid remaining in the dispenser at the end of the cycle is water, not bleach.

- Do not add powdered bleach to this compartment. The bleach compartment is designed to dispense liquid bleach only. Powdered or liquid color-safe bleach will not dispense properly.
- Always follow the manufacturer's recommendations when adding bleach. Never add more than one cup and do not exceed the maximum fill line since this can cause the bleach to be dispensed immediately, resulting in damage to fabrics. Using too much bleach can damage fabrics.
- Never pour undiluted liquid chlorine bleach directly onto the load or into the tub. Fabric damage can occur.
- Do not use color-safe bleach or Oxi products in the same cycle with liquid chlorine bleach.

MAIN WASH DETERGENT COMPARTMENT

This compartment holds laundry detergent for the main wash cycle. The detergent is added to the load at the beginning of the cycle. Always use High-Efficiency (HE) detergent with your washing machine. Either powdered or liquid detergent may be used.

Never exceed the manufacturer's recommendations when adding detergent. Using too much detergent can result in detergent buildup in clothing and the washer.

When using liquid detergent, make sure the liquid detergent cup and insert are in place. Do not exceed the maximum fill line.

When using powdered detergent, remove the liquid detergent cup from the compartment. Powdered detergent will not dispense with the liquid detergent cup in place.

FABRIC SOFTENER COMPARTMENT

This compartment holds liquid fabric softener, which is automatically dispensed during the final rinse cycle.

Never exceed the manufacturer's recommendations when adding softener. Using too much fabric softener can result in buildup in clothing and the washer. Either powdered or liquid fabric softener may be used.

- Always follow the manufacturer's recommendations when adding fabric softener. Do not exceed the maximum fill line. Using too much fabric softener may stain clothes.
- Dilute concentrated fabric softeners with warm water. Do not exceed the maximum fill line.
- Never pour fabric softener directly onto the load or into the tub.

⚠ DANGER

- Do NOT mix chlorine bleach with ammonia or acids, such as vinegar or rust/scale remover. Mixing chemicals like these can produce a lethal gas, resulting in severe injury or death.

DETERGENT AND DISPENSER USE A WORD ABOUT DETERGENTS

High-Efficiency (HE) detergents produce fewer suds, dissolve more efficiently to improve washing and rinsing performance, and help to keep the interior of your washer clean. Using detergent that is not HE may cause oversudsing and unsatisfactory performance which could result in error codes, cycle failure, and machine damage.

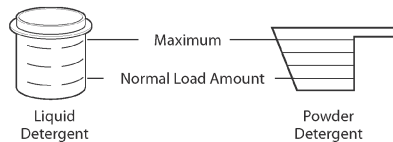

For proper wash performance, always measure the detergent using the measurements provided by the detergent manufacturer.

The normal amount of HE detergent needed, for average loads, is less than ½ of the recommended maximum. Use less detergent for soft water, light soil or smaller loads. Never use more than the maximum amount recommended by the detergent manufacturer.



**DESIGNED TO USE ONLY
HIGH-EFFICIENCY (HE)
DETERGENT**

IMPORTANT: Your washing machine is designed for use with only High-Efficiency (HE) detergents. HE detergents are formulated specifically for High-Efficiency washers and contain suds-reducing agents. Always look for the HE symbol when purchasing detergent.

IMPORTANT: Not all detergents are the same. Pay careful attention to the amount of detergent used to avoid oversudsing, poor rinsing and detergent buildup in clothing, and residue buildup that can contribute to odors in the machine. NEVER use a cup or scoop other than the one supplied by the manufacturer of the detergent you are using. Never use more than the maximum amount of detergent recommended by the manufacturer. A full scoop or measure of detergent should only be used for very large and heavily soiled loads. Using too much detergent can result in detergent buildup in the washer and in your clothes.

Always measure the detergent amount. While HE detergents are designed for this type of washing machine, be careful when measuring the detergent. For most normal loads, no more than 1/4 to 1/2 of cap or scoop of HE detergent should be used.

NOTE:

- Extra care must be exercised when using 2X and 3X concentrated detergents because even a little bit extra can contribute to the problems mentioned above.
- Detergents designated as HE compatible may not provide optimal results.

USING THE SOFTENER AND DETERGENT DISPENSER

To add detergent, bleach, and fabric softener to the automatic dispenser:

1. Open the dispenser drawer.
2. Load the laundry products into the appropriate compartments.
3. Close the drawer before starting the cycle.

4. If using fabric softener on NORMAL or HEAVY DUTY cycles, press the FABRIC SOFTENER button or select the EXTRA RINSE option.

NOTE: It is normal for a small amount of water to remain in the bleach and softener compartments at the end of the cycle.

IMPORTANT: Do not place or store laundry products, such as detergent, bleach, or liquid fabric softener, on top of your washer or dryer. Wipe up any spills immediately. These products can damage the finish and controls.

USING THE LIQUID BLEACH DISPENSER



The bleach dispenser automatically dilutes and dispenses liquid bleach at the proper time in the wash cycle.

1. Check clothing care labels for special instructions.
2. Measure liquid bleach carefully, following instructions on the bottle. High-efficiency washers use less water, so less bleach is needed. One half cup is enough for most loads.
3. Carefully pour the pre-measured amount of bleach directly into the bleach dispenser. If you are using powdered bleach of any kind, pour it directly into the tub before adding the laundry. Never add powdered bleach to the liquid bleach dispenser.
 - Never pour undiluted liquid chlorine bleach directly onto clothes or into the tub.
 - Do not pour powdered bleach into bleach dispenser.
 - Do not place laundry items on top of the bleach dispenser when loading and unloading the washer.
 - Always measure and pour bleach carefully. Avoid overfilling or splashing when adding bleach to the dispenser. The maximum capacity of the bleach dispenser is one cup of bleach per wash cycle. Overfilling could result in bleach being dispensed immediately, which can result in damage to the clothes in the washer.

HOW TO USE

CONTROL PANEL FEATURES

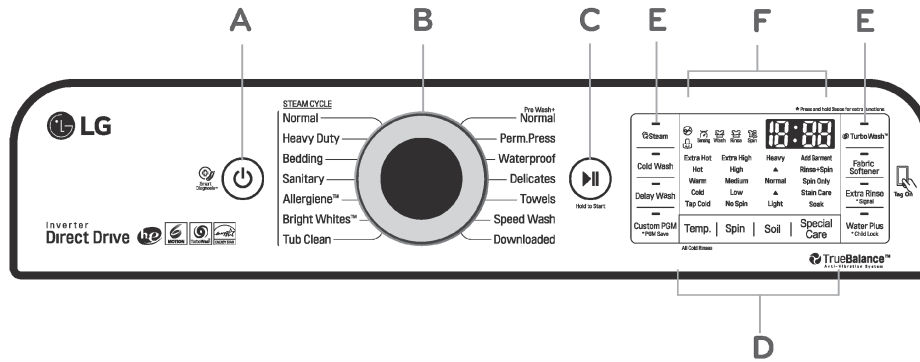

ENGLISH

A POWER (ON/OFF) BUTTON

Press to turn ON the washer. Press again to turn the washer OFF. Pressing the POWER button during a cycle will cancel that cycle and any load settings will be lost. The lid will unlock after a brief pause.

NOTE: If there is any water remaining in the tub after the washer shuts off, it will drain following a five minute delay. The washer can be restarted any time before the drain begins. However, once the water begins to drain, all functions will be suspended until the water has been completely drained and the washer shuts off.

B CYCLE SELECTOR KNOB

Turn this knob to select the desired cycle. Once the desired cycle has been selected, the standard presets will appear in the display. These settings can be adjusted using the cycle setting buttons anytime before starting the cycle.

NOTE: To protect your clothing, not all settings are available on all cycle selections.

C START/PAUSE BUTTON

Press this button to start the selected cycle. If the washer is running, use this button to pause the cycle without losing the current settings.

NOTE: If you do not press the START/PAUSE button within one hour of selecting a cycle, the washer automatically turns OFF and all cycle settings are lost. Any water remaining in the tub will drain after a one hour delay.

D CYCLE MODIFIER BUTTONS

Use these buttons to adjust the settings for the selected cycle. The setting lights above the buttons illuminate to show the current selection.

E SPECIAL CYCLE AND OPTION BUTTONS

These buttons allow you to select special cycles or options.

F TIME AND STATUS DISPLAY

The display shows the cycle status and estimated time remaining.

TIME AND STATUS DISPLAY

The time and status display shows the estimated time remaining and cycle progress.

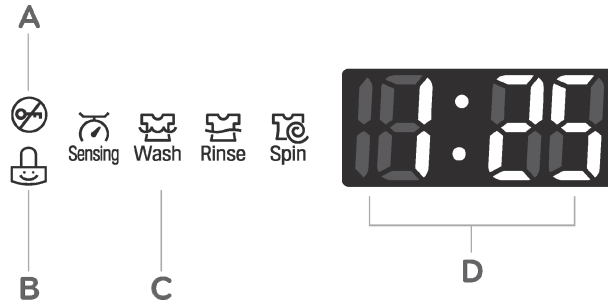

- A LID LOCK INDICATOR**
The Lid Lock indicator illuminates once a cycle has started. The indicator light stays on until the cycle is paused, stopped or has finished.
- B CHILD LOCK**
When the Child Lock function is activated, the LED lights up. When the Child Lock function is set, except for the POWER button, the other functions are disabled. Once the Child Lock function is disabled, the LED turns off.

- C CYCLE STATUS INDICATOR**
These LEDs illuminate when a cycle is selected to indicate which stages will run. When a cycle is running, the LED for the active stage blinks, and the LEDs for the remaining stages remain steady. Once a stage is complete, the LED turns off. If a cycle is paused, the active stage LED stops blinking.
- D ESTIMATED TIME REMAINING**
When a cycle is selected, the default time for that cycle is displayed. This time will change as modifiers or options are selected. Once the START/PAUSE button is pressed, the washer measures the size of the load. The estimated time may change once the load size has been measured. If Delay Wash is set, the remaining delay time counts down until the cycle begins.

NOTE: The time shown is only an estimate. This time is based on normal operating conditions. Several external factors (load size, room temperature, incoming water temperature, water pressure, etc.) can affect the actual time.

ENGLISH

OPERATING THE WASHER

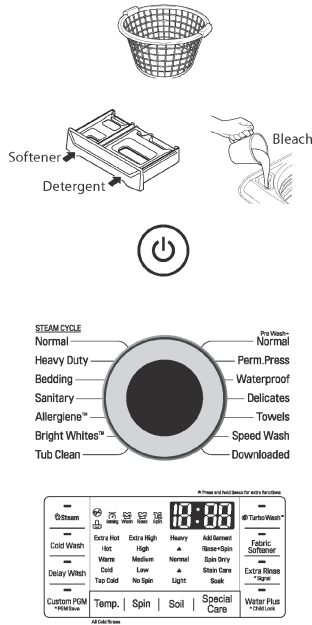

Add Garment

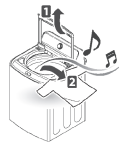

- 1 SORT LAUNDRY AND LOAD THE WASHER**
 Sort laundry by fabric type, soil level, color and load size, as needed. Open the lid and load items into the washer.
- 2 CLEANING PRODUCTS**
 Add High-Efficiency (HE) detergent to the detergent dispenser. If bleach or fabric softener is to be used, add these to the appropriate dispensers
- 3 TURN ON THE WASHER**
 Press the POWER button to turn ON the washer. The lights around the cycle selector knob illuminate and a chime sounds.
- 4 SELECT A CYCLE**
 Turn the cycle selector knob in either direction to select the desired cycle. The preset Wash Temp., Spin Speed, Soil Level, Special Care and option settings for that cycle are shown. Pressing the Start Pause button without selecting a cycle will cause the Normal cycle to begin immediately.
- 5 ADJUST SETTINGS**
 Default settings for the selected cycle can now be changed, if desired, using the cycle modifier and option buttons.

NOTE: Not all modifiers and options are available on all cycles. A different chime sounds and the LED does not come on if the selection is not allowed.
- 6 BEGIN CYCLE**
 Press the START/PAUSE button to begin the cycle. The lid locks, and the washer agitates briefly without water to measure the weight of the load. If the START/PAUSE button is not pressed within 5 minutes, the washer shuts off and all settings are lost.
- 7 ADD GARMENT LIGHT**
 The ADD GARMENT light illuminates near the beginning of the wash cycle to indicate when it is safe to add items to the load. Press the START/PAUSE button to pause the cycle and add garments to the load. Press the START/PAUSE button to resume the cycle.

NOTE: It is not recommended to add items unless the ADD GARMENT light is illuminated, as this could result in poor performance.
- 8 END OF CYCLE**
 When the cycle is finished, a melody sounds. Immediately remove the clothing from the washer to reduce wrinkling.

⚠ WARNING

- To reduce the risk of fire, electric shock, or injury to persons, **read the IMPORTANT SAFETY INSTRUCTIONS** before operating this appliance.

CYCLE GUIDE

The cycle guide below shows the default settings, available options and recommended fabric types for each cycle. Allowable modifier adjustments are shown below the default setting for each cycle.

- Default Setting
- Available options
- ★ Cannot be used if Steam is selected
- Turbo Wash™ will be deselected

Cycle	Fabric or Load Type	Wash Mode	Temp.	Spin	Soil	Soak	Stain Care	Extra Rinse	Water Plus	Delay Wash	PGM Save
Normal	Cotton, linen, shirts, jeans, mixed loads	Steam	Extra Hot ^b	Extra High	Heavy						
		Turbo Wash™	Hot	High	Heavy	★	■ ^c	●	●	●	●
		Cold Wash ^b	Warm	Medium	Normal						
Heavy Duty	Heavily soiled cotton fabrics	No Option	Hot	Extra High	Heavy						
		Turbo Wash™	Warm	High	Heavy	★	■	●	●	●	●
		Cold Wash	Cold	Medium	Normal						
Bedding	Large items such as blankets, comforters, and sheets.	No Option	Hot	Extra High	Heavy						
		Steam	Warm	High	Heavy	★		●		●	●
		Cold Wash	Cold	Medium	Normal						
Use the Bedding cycle for items such as pillows, comforters, pet bedding and other articles which have difficulty absorbing water. DO NOT WASH EXCESSIVELY LARGE ITEMS. If large/bulky items do not fit easily into the tub, there may not be enough room for them to move during washing. Keep like items together; do not mix large bulky items with smaller clothing items. Failure to follow these instructions may result in damage to the clothing or to the washer.											
Sanitary	White fabrics	No Option	Extra Hot	Extra High	Heavy						
		Steam	Hot	High	Heavy	★		●	●	●	●
		Turbo Wash™	Warm	Medium	Normal						
Allergiene™	Heavily soiled underwear, work clothes, diapers, etc. (less than 11 lbs.)	No Option	Extra Hot	Extra High	Heavy						
		Steam	Hot	High	Heavy			●	●	●	●
		Cold Wash	Cold	Medium	Normal						
Bright Whites™	Underwear, pillow covers, bed sheets, baby wear. (less than 12 lbs.)	No Option	Extra Hot	Extra High	Heavy						
		Steam	Hot	High	Heavy	★		●	●	●	●
		Turbo Wash™	Warm	Medium	Normal						
Tub Clean	Refer to page 27.	No Option	Extra Hot	Extra High	Heavy						
		Steam	Hot	High	Heavy					●	
		Fabric Softener	Tap Cold	No Spin	Light						

^b Cold Wash and Extra Hot are not available with the Heavy soil level.

^c Stain Care cannot be used if Cold Wash is selected.

NOTE: The following options can only be used independently of each other: Steam, Turbo Wash™, Cold Wash.
Soak and Stain Care cannot be selected together.
Fabric softener and Turbo Wash™ cannot be selected together.

CYCLE GUIDE

The cycle guide below shows the default settings, available options and recommended fabric types for each cycle. Allowable modifier adjustments are shown below the default setting for each cycle.

- Default Setting
- Available options
- ★ Cannot be used if Steam is selected
- Turbo Wash™ will be deselected

ENGLISH

Cycle	Fabric or Load Type	Wash Mode	Temp.	Spin	Soil	Soak	Stain Care	Extra Rinse	Water Plus	Delay Wash	PGM Save
Pre Wash+ Normal	Heavily soiled fabrics that require pre-washing.	Turbo Wash™	Extra Hot Hot	Extra High High	Normal	●		●	●	●	●
			Warm	Medium	Light						
		Fabric Softener	Cold Tap Cold	Low No Spin	Heavy						
Perm. Press	Dress shirts/pants, wrinkle-free clothing, poly/cotton blend clothing, table-cloths	No Option		High	Heavy						
		Turbo Wash™	Warm	Medium	Normal	●		●	●	●	●
		Cold Wash	Cold Tap Cold	Low No Spin	Light						
Waterproof	Waterproof items - i.e. Water resistant clothing, mattress covers, outdoor clothes, plastic mats etc. (less than 14 lbs.)	No Option			Heavy						
			Warm	Low	Normal			●	●	●	●
		Fabric Softener	Cold Tap Cold	No Spin	Light						
Delicates	Dress shirts/blouses, nylons, sheer or lacy garments (less than 8 lbs.)	No Option			Heavy						
			Warm	Low	Normal	●		●	●	●	●
		Fabric Softener	Cold Tap Cold	No Spin	Light						
Towels	Big towels, small towels	No Option		Extra High	Heavy						
		Turbo Wash™	Hot	High	Normal	●	■ ^c	●	●	●	●
		Cold Wash	Warm	Medium	Light						
Speed Wash	Lightly soiled and small loads			Extra High	Heavy						
		Turbo Wash™	Warm	High	Normal	●		●	●	●	●
			Cold Tap Cold	Low No Spin	Light						
Downloaded	The downloaded cycle (See page 22.)										

^b Cold Wash and Extra Hot are not available with the Heavy soil level.

^c Stain Care cannot be used if Cold Wash is selected.

NOTE: The following options can only be used independently of each other: Steam, Turbo Wash™, Cold Wash.

Soak and Stain Care cannot be selected together.

Fabric softener and Turbo Wash™ cannot be selected together.

NOTE:

To protect your garments, not every wash/rinse temperature, spin speed, soil level, or option is available with every cycle. A chime will sound and the LED will not light if the selection is not allowed.

*When a cycle is selected, the default time for that cycle is displayed. This time will change as modifiers or options are selected. Once the START/PAUSE button is pressed, the washer will measure the load. The estimated time may change once the load has been measured. The washer automatically adjusts the wash time for the amount of laundry, water pressure, water and other operating conditions.

WASH CYCLES

Wash cycles are designed for the best wash performance for each type of load. Select the cycle that best matches the load contents for maximum wash performance and fabric care. Turn the knob to the desired cycle. When you select a wash cycle, the light for the corresponding wash cycle will turn on. See page 19, **OPERATING THE WASHER**, for more details on operating methods.

Normal

Use this cycle to wash all normal items, except delicate fabrics such as wool or silk.

NOTE: Pressing the START/PAUSE button without selecting a cycle will cause the NORMAL cycle to begin immediately using the default settings.

Heavy Duty

This cycle is for washing heavily soiled laundry using more powerful wash motions.

NOTE: When washing large loads, in order to deliver the best performance, there will be brief periods of 2 minutes or more without agitation. These soak periods are part of the cycle's design, and are normal.

Bedding

This cycle is for washing blankets or bulky items.

NOTE: Do not use this cycle to wash a mixed load of bedding and non-bedding items.

Sanitary

This wash cycle reduces 99.9% bacteria on laundry through high temperature.

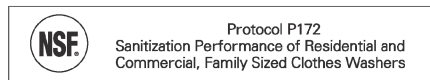

Allergiene™

This cycle is a powerful, high temperature cycle designed specifically to reduce certain allergens.

NOTE:

- Selecting the ALLERGIENE™ cycle automatically incorporates steam into the wash cycle.
 - The ALLERGIENE™ cycle can significantly reduce allergens in bedding and clothing.
 - The ALLERGIENE™ cycle helps reduce dust mite populations and helps reduce allergens.
- Due to the higher energy and temperatures used, the ALLERGIENE™ cycle is not recommended for wool, silk, leather, or any other delicate or temperature-sensitive items

Bright Whites™

This cycle is for washing white items only.

Tub Clean

Use this cycle to clean the tub of your washing machine.

Pre Wash+ Normal

Use this cycle to prewash stains without needing to hand-wash.

Prompt treatment helps to prevent stains from setting or odors from developing.

To use:

1. Put items to be prewashed in washer. Add prewash detergent amount and desired additives to dispenser and start cycle.
- NOTE:** Do not mix liquids with powders in dispenser. Put powdered additives in tub if using liquid detergent. Liquid chlorine bleach is not dispensed during prewash.
2. When chime sounds, press Pause to unlock lid, add main detergent to dispenser, and insert remainder of laundry. If Pause is not pressed within about 3 minutes, the cycle continues. (If Signal is turned off, the chime won't sound.)
 3. Press Start to restart the cycle.

Perm.Press

This cycle is for washing items such as wrinkle-free clothes or tablecloths to minimize wrinkles.

Waterproof

This cycle is used for washing waterproof material.

NOTE:

- Do not use any other wash cycle to wash waterproof fabrics. (i.e. Water resistant clothing, mattress covers, outdoor clothes, plastic mats etc.)
- Do not use this cycle to wash a mixed load of waterproof and non-waterproof items.
- Use only the waterproof cycle, after checking the washing instruction label on the fabric.
- Do not wash other fabrics using the waterproof cycle.

⚠ WARNING

- If waterproof material laundry is washed in a course other than Waterproof, it may result in injury or damage to the washer, clothes, walls, floor, and surrounding objects due to abnormal vibration.

Delicates

This cycle is for washing lingerie or sheer and lacy clothes which can easily be damaged.

Towels

Use this cycle for washing towels, shirts, jeans and mixed loads.

Speed Wash

Use the Speed Wash cycle to quickly wash lightly soiled clothing and small loads. For high wash and rinse efficiency, washing small loads of 2-3 lightly soiled garments is recommended.

NOTE: Use very little detergent in this cycle. If you want additional rinsing, you can add extra rinses by using the Extra Rinse button.

Downloaded

If you downloaded a cycle using the Tag On feature, it will be placed in the Download cycle position. Choose the Downloaded cycle to run the Downloaded cycle.

NOTE: The default cycle for this position is Small Load, used for normally soiled loads with just a few items. The Small Load cycle is also available to download.

CYCLE MODIFIER BUTTONS

Each cycle has default settings that are selected automatically. You may also customize these settings using the cycle modifier buttons. Press the button for the desired modifier until the indicator light for the desired setting is lit. The washer automatically adjusts the water level for the type and size of wash load for best results and maximum efficiency. Due to the high-efficiency nature of this

product, water levels may be much lower than expected. This is normal and cleaning/rinsing performance will not be compromised.

NOTE: To protect your garments, not every wash/rinse temperature, spin speed, soil level, or option is available with every cycle. A chime will sound and the LED will not light if a selection is not allowed.

Extra Hot	Extra High	Heavy	Add Garment
Hot	High	▲	Rinse+Spin
Warm	Medium	Normal	Spin Only
Cold	Low	▲	Stain Care
Tap Cold	No Spin	Light	Soak
<div style="border: 1px solid black; padding: 5px; display: inline-block;"> Temp. Spin Soil Special Care </div>			

TEMP.

TEMP. selects the wash and rinse temperature combination for the selected cycle. Press the TEMP. button until the indicator light for the desired setting is lit. All rinses use tap cold water.

- Select the water temperature suitable for the type of load you are washing. Follow the garment fabric care labels for best results.

SPIN SPEED

Higher spin speeds extract more water from clothes, reducing drying time and saving energy.

Press the SPIN SPEED button until the desired speed is selected. Some fabrics, such as delicates, require a slower spin speed. To protect your clothing, not all spin speeds are available for all cycles.

SOIL LEVEL

Adjusting the soil level setting will modify the cycle times and/or wash actions. Press the SOIL LEVEL button until the desired soil level is selected.

NOTE: This feature needs more time for heavily soiled loads or less time for lightly soiled loads.

SPECIAL CARE

Pressing the SPECIAL CARE button will allow you to select additional features, such as Soak, Stain Care, Spin Only, and Rinse+Spin. Pressing the SPECIAL CARE button before selecting a cycle will automatically default to the Normal cycle with the Soak feature selected.

SPECIAL CARE FEATURES

After selecting a cycle, press the SPECIAL CARE button to select additional features for your load.

NOTE:

- To protect your garments, not every feature is available with every cycle.
- If the START/PAUSE button is not pressed within five minutes to start the cycle, the control will shut off and all settings will be lost.

SOAK

This option provides a 30 minute presoak prior to the start of the selected cycle. Use the SOAK option to presoak garments to help remove difficult spots or stains on fabrics. At the end of the presoak time, the selected cycle will begin with the same water used for the soak.

NOTE: You cannot select the SOAK option in the TUB CLEAN, ALLERGIENE™ and STEAM WASH cycle.

STAIN CARE

Use this option for heavily soiled loads that need improved stain treatment. When Stain Care is selected, the wash cycle will begin with warm water to help prevent the setting of certain types of stains. Then, as the cycle progresses, hot water will be added to gradually increase the water temperature to help remove stains that require treatment at higher temperatures.

NOTE:

- Best results are obtained with smaller loads (less than 6 lbs.)
- If you select STAIN CARE, the COLDWASH option is not available.

SPIN ONLY

Use this option to drain the water from the tub and spin out the clothes. This can be used, for example, if the wash cycle is interrupted by a power failure. The spin speed can be adjusted by using the SPIN ONLY button.

1. Press the POWER button to turn on the washer.
2. Press the SPECIAL CARE button repeatedly until Spin Only is selected.
3. Press the SPIN SPEED button to select the desired spin speed. Selecting NO SPIN is not allowed.
4. Press the START/PAUSE button.

RINSE + SPIN

Select this option to rinse and spin a load separately from a regular cycle. This can be helpful in preventing fresh stains from setting in fabrics. You can change the spin speed by pressing the SPIN SPEED button.

1. Press the POWER button to turn on the washer.
2. Press the SPECIAL CARE button until the RINSE+SPIN indicator light is lit. (The cycle light will turn off.)
3. Press the START/PAUSE button to start the cycle.

SPECIAL DRAIN FEATURE

This washer is equipped with a special feature that is designed to make your washer as safe as possible. If the washer is paused or shut off while there is still water in the tub, the water will drain automatically after several minutes of inactivity. This helps keep children safe by reducing the possibility of water remaining in the tub.

Any water remaining in the tub will automatically drain 4 minutes after the washer has shut off. If the washer is paused and the START/PAUSE button is not pressed within 60 minutes, the washer will shut off and all cycle settings will be lost. Any water remaining will drain five minutes later.

The washer can be turned on or restarted any time before the drain begins. However, once the water begins to drain, all functions will be suspended until the water has been completely drained and the washer shuts off.

OPTION BUTTONS

Your washing machine features several additional cycle options that customize cycles to meet your individual needs. To use these options, select the desired option AFTER selecting the desired cycle.

After selecting the desired cycle and settings, press the cycle option button(s) for the option(s) you would like to add. The button will light when that option is selected. If the selected option is not allowed for the selected cycle, the chime will sound twice to alert you and the LED will not illuminate.

NOTE:

- To protect your garments, not every option is available with every cycle.
- If the START/PAUSE button is not pressed within 60 minutes to start the cycle, the control will shut off and all settings will be lost.

STEAM

Adding the Steam option to a wash cycle helps provide superior cleaning performance. By using hot steam, the fabrics will get the cleaning benefits of a very hot wash.

WARNING

- **Do not touch the lid during steam cycles.** The lid surface can become very hot. Allow the lid lock to release before opening the door.
- **Do not attempt to override the lid lock mechanism or reach into the washer during a steam cycle.** Steam can cause severe burns.

NOTE:

- The steam option cannot be used with all cycles.
- The STEAM option is automatically deselected if Turbo Wash™ is selected for the NORMAL, HEAVY DUTY, BRIGHT WHITES™ and SANITARY cycles.
- Steam may not be clearly visible during the steam cycles. This is normal. Too much steam could damage clothing.
- Do not use steam with delicate fabrics such as wool, silk, or easily discolored fabrics.

COLD WASH

This option saves energy by using cooler water while increasing the wash and rinse times to maintain wash performance.

NOTE:

- The Stain Care feature cannot be selected with the Cold Wash option.
- Wash time will increase up to 50 minutes with the Cold Wash option.
- For best wash results, only wash small loads (less than 8 pounds) with the Cold Wash option.

DELAY WASH

Once you have selected the cycle and other settings, press this button to delay the start of the wash cycle. Each press of the button increases the delay time by one hour, for up to 19 hours. Once the desired delay time is set, press the START/PAUSE button to start the delay time.

NOTE: If the START/PAUSE button is not pressed to begin the delay time, the washer will automatically shut off after five minutes and all cycle settings will be lost.

CUSTOM PROGRAM (PGM)

Custom Program allows you to store a customized wash cycle for future use. It allows you to save your favorite temperature, spin speed, soil level, and other options for a cycle, and then recall them at the touch of a button. To create a Custom Program:

1. Press the POWER button to turn on the washer.
2. Turn the cycle selector knob to select the desired cycle.
3. Press the cycle modifier button to change the desired setting.
4. Press the cycle option button to add the desired options.
5. Press and hold the CUSTOM PGM button for 3 seconds.

TO RECALL A CUSTOM PROGRAM:

1. Press the POWER button to turn on the washer.
2. Briefly press the CUSTOM PGM button. The stored settings will display.
3. Press the START/PAUSE button to start the cycle. (Pressing any other button at this time will cancel the Custom Program.)

NOTE: You may only save one custom program at a time. Pressing and holding the CUSTOM PGM button will overwrite any previously saved custom program.

TURBO WASH™

Adding the Turbo Wash option reduces the cycle time while still providing similar wash performance to the same cycle without Turbo Wash.

NOTE:

- The Turbo Wash™ option cannot be used with all cycles.
- Turbo Wash™ defaults ON for NORMAL, Pre Wash +NORMAL and SPEED WASH cycles.
- Turbo Wash is automatically deselected for NORMAL, HEAVY DUTY, BRIGHT WHITES™ and SANITARY cycles if the STEAM option is selected.

FABRIC SOFTENER

The fabric softener is dispensed in the final rinse. Select the FABRIC SOFTENER button if you are using fabric softener to optimize the final rinse for softener use.

EXTRA RINSE

This option will add an extra rinse to the selected cycle. Use this option to help ensure the removal of detergent or bleach residue from fabrics. Liquid fabric softener, if used, is always dispensed in the final rinse.

NOTE: You cannot select the Extra Rinse option with the Spin Only option and Tub Clean cycle.

WATER PLUS

Use this option if you wish to add more water to your wash load. This option is especially useful for large or bulky loads.

NOTE:

- If the washing machine reaches its maximum water level, the WATER PLUS button will have no effect.
- You cannot select the WATER PLUS option in the Tub Clean and Bedding cycles.

SIGNAL

The washing machine plays a melody when the wash cycle has finished. The volume of the melody is adjusted using the EXTRA RINSE button.

Press and hold the EXTRA RINSE button for three seconds to adjust the volume of the signal. Press the button repeatedly to adjust the volume of the melody. When no signal is heard, the signal is off. The volume settings are LOW – HIGH – OFF. The signal volume can be adjusted at any time as long as the washer is turned ON.

CHILD LOCK

Use this option to disable the controls. The washer can only be locked during a cycle. This feature can prevent children from changing cycles or operating the machine. Once the Child Lock is set, it must be deactivated before any controls, except the power button, can be used. Once the washer has shut off, the power button will allow the machine to be turned ON, but the controls will still be locked. When the controls are locked, CL will display alternately with the estimated time remaining.

Press and hold the WATER PLUS button for three seconds to activate or deactivate Child Lock.

NOTE: Once the controls are locked, they must be manually unlocked to restore operation.

ADD GARMENT

Laundry may ONLY be added to the load at the proper time in the wash cycle. When the ADD GARMENT light is illuminated, it is safe to pause the cycle and add more items to the load. If garments are added when the ADD GARMENT light is off, the washer will not adjust for these items which could result in poor performance and/or fabric damage.

1. Press the START/PAUSE button to pause the washer.
2. Open the lid after it unlocks.
3. Add your additional items.
4. Close the lid.
5. Press the START/PAUSE button. The cycle will resume after the lid locks.

NOTE:

- The ADD GARMENT light is an indicator only and is not selected by pressing the SPECIAL CARE button.
- If the washer remains idle for 4 minutes after pausing the cycle, the water in the tub will drain.

CARE AND CLEANING

ENGLISH

⚠ WARNING

To reduce the risk of fire, electric shock, or injury to persons, read and follow this entire Owner's Manual, including the Important Safety Instructions, before operating this washer.

- **Unplug the washer before cleaning to avoid the risk of electric shock.** Failure to follow this warning can cause serious injury, fire, electric shock, or death.
- **Never use harsh chemicals, abrasive cleaners, or solvents to clean the washer.** They will damage the finish.

REGULAR CLEANING

CLEANING THE EXTERIOR

Proper care of your washer can extend its life. The outside of the machine can be cleaned with warm water and a mild, nonabrasive household detergent. Immediately wipe off any spills with a soft, damp cloth.

IMPORTANT: Do not use solvents, cleaning alcohols, or similar products. Never use steel wool or abrasive cleaners because they can damage the surface.

CARE AND CLEANING OF THE INTERIOR

Use a towel or soft cloth to wipe around the washer lid opening and lid glass.

Always remove items from the washer as soon as the cycle is complete. Leaving damp items in the washer can cause wrinkling, color transfer, and odor. Run the Tub Clean cycle once a month, or more often if needed, to remove detergent buildup and other residue.

TUB CLEAN CYCLE

Some environmental and usage conditions can cause a residue to build up in the tub over time and can lead to a mildewy or musty smell. The Tub Clean cycle is specially designed to remove this buildup using bleach or another cleaners designed specifically for cleaning washing machines. Run the Tub Clean cycle once a month, or more often under heavy use conditions or if odor is present

1. Remove any clothing from the tub.
2. Fill the bleach dispenser to the MAX line with liquid chlorine bleach. Do not overfill the bleach dispenser. Overfilling will cause the bleach to dispense immediately.

NOTE: For other tub cleaning products, follow the cleaner manufacturer's instructions and recommendations. For powdered cleaning products, add the cleaner to the main wash compartment of the dispenser drawer after removing the liquid detergent dispenser insert.

3. Close the lid and press the POWER button to turn the washer ON. Turn the knob to select the TUB CLEAN cycle then press the START/PAUSE button to begin the cycle. Selecting any other cycle after Tub Clean has been selected will cause the Tub Clean cycle to be cancelled.
4. After the cycle ends, open the lid and allow the tub interior to dry completely.

NOTE:

- Never load laundry while using TUB CLEAN. The laundry may be damaged or contaminated with cleaning products. Make sure to run the Tub Clean cycle ONLY when it is empty.
- It is recommended to leave the lid open after finishing the laundry to keep the tub clean.
- It is recommended that TUB CLEAN should be repeated monthly.
- If mildew or musty smell already exists, run TUB CLEAN for 3 consecutive weeks.

REMOVING MINERAL BUILDUP

If you live in an area with hard water, mineral scale can form on internal components of the washer. Use of a water softener is recommended in areas with hard water.

Use a descaler, such as Washer Magic[®], to remove visible mineral buildup. After descaling, always run the Tub Clean cycle before washing clothing.

Mineral scale and other spots may be removed from the stainless steel tub using a stainless steel cleaner. Do NOT use steel wool or abrasive cleaners.

LEAVE THE LID OPEN

If the washer will not be used for several days, leave the lid open overnight to allow the tub to dry.

MAINTENANCE

CLEANING THE WATER INLET FILTERS

If the washer does not fill properly, an error message will show on the display. The inlet valve filter screens could be plugged by hard water scale, sediment in the water supply, or other debris.

NOTE: The inlet screens protect the delicate parts of the inlet valve from being damaged by particles that could enter the valves with the water supply. Operating the washer with these filters removed could cause a valve to stick open resulting in flooding and/or property damage.

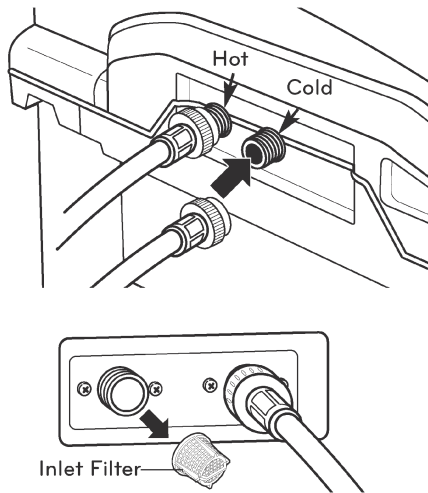

1. Turn OFF both water faucets completely. Unscrew the hot and cold water lines from the back of the washer.

IMPORTANT: Aftermarket hoses are not guaranteed to fit or function correctly. Other hoses may not tighten correctly and could cause leaks. Subsequent damage to product or property will not be covered under the terms of the product warranty.

2. Carefully remove the filters from the water valves and soak them in white vinegar or a lime scale remover, following the manufacturer's instructions. Be careful not to damage the filters while cleaning.
3. Rinse thoroughly before reinstalling. Press the filters back into place.
4. Before reattaching the hoses, flush the hoses and water lines by running several gallons of water into a bucket or drain, preferably with the faucets wide open for maximum flow.

NOTE: *IE* message may blink on the display when the water pressure is weak or an inlet filter is clogged with dirt. Clean the inlet filter.

⚠ WARNING

- **Unplug the power cord and turn off the faucets before cleaning.** Failure to do so may cause electric shock.
- **Do not use the washing machine without the inlet filters.** If you use the washing machine without the inlet filters it will cause leaks and malfunction.
- If you use the washing machine in an area with hard water, the inlet filter may clog due to lime buildup.

STORING THE WASHER

If the washer will not be used for an extended period of time and is in an area that could be exposed to freezing temperatures, perform the following steps to protect the washer from damage.

1. Turn OFF the water supply.
2. Disconnect hoses from water supply and drain water from hoses.
3. Plug the power cord into a properly grounded electrical outlet.
4. Add 1 gallon of nontoxic recreational vehicle (RV) antifreeze to the empty tub and close the lid. **Never** use automotive antifreeze.
5. Press the POWER button, then select SPIN ONLY. Press the START/PAUSE button to activate the drain pump. Allow the drain pump to run for one minute, then press the POWER button to shut off the washer. This will expel some of the antifreeze, leaving enough to protect the washer from damage.
6. Unplug the power cord, dry the tub interior with a soft cloth, and close the lid.
7. Remove the inserts from the dispenser. Drain any water in the compartments and let them dry.
8. Store the washer in an upright position.
9. To remove the antifreeze from the washer after storage, run a complete Speed Wash cycle using detergent. Do not add laundry to this cycle.

CLEANING THE WASHER PROPER USE OF DETERGENT

Using too much detergent is a common cause of laundry problems. Today's detergents are formulated to be effective without visible sudsing. Be sure to carefully read and follow manufacturer's recommendations for how much detergent to use in your wash. You can use less detergent if you have soft water, a smaller load, or a lightly soiled load.

NOTE: Use only low-sudsing, high-efficiency detergent. These detergents can be identified by the HE logo. 

WARNING

- Do not spray water inside the washing machine. Doing so may cause fire or electric shock.

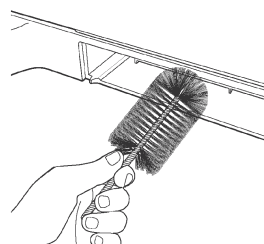
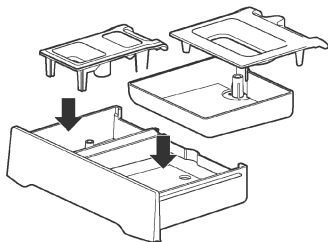
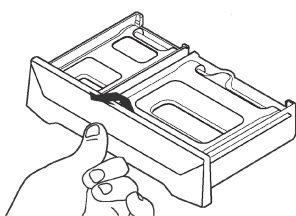
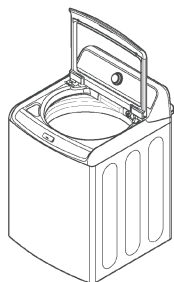

ENGLISH

CARE AND CLEANING OF THE WASHER

Lid: Wash with a damp cloth on the outside and inside and then dry with a soft cloth.

Exterior: Immediately wipe off any spills. Wipe with damp cloth. Do not touch the surface or the display with sharp objects.

Moving and Storage: Contact a service technician to remove water from the drain pump and hoses. Reinstall the foam tub block to protect the washer from damage while moving. Do not store the washer where it will be exposed to outdoor weather conditions.

Long Vacations: Be sure water supply is shut off at the faucets. Follow the instructions in the Storing the Washer section if the washer will be exposed to freezing temperatures.

Dispenser Drawer: Detergent and fabric softener may build up in the dispenser drawer. Remove the drawer and inserts and check for buildup once or twice a month.

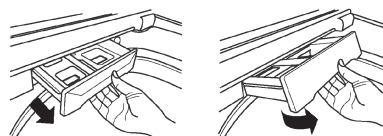

1. Remove the drawer by pulling it straight out until it stops. Lift up on the front of the drawer and pull it completely out.
2. Remove the inserts from the two compartments. Rinse the inserts and the drawer with warm water to remove buildup from laundry products.
3. To clean the drawer opening, use a small, non-metal brush to clean the recess. Remove all residue from the upper and lower parts of the recess.
4. Return the inserts to the proper compartments and replace the drawer. Set the drawer into the opening at an angle as shown above, then lower it and slide it into place.

SPECIFICATIONS

Model WT7600H*A	
Description	Top-Loading Washer
Electrical requirements	120 VAC @ 60 Hz.
Max. water pressure	14.5~116 PSI (100~800 kPa)
Dimensions	27"(W) X 28 3/8"(D) X 44 1/2" (H), 57 1/4" (H with lid open) 68.6 cm (W) X 72.1 cm (D) X 113 cm (H), 145.3 cm (H with lid open)
Net weight	146.9 lbs. (66.5kg)
Max. spin speed	950 RPM (±50 RPM)

SMART DIAGNOSIS™ SYSTEM

Should you experience any problems with your washing machine, it has the capability of transmitting data via your telephone to the Smart Diagnosis Team. This gives you the capability of speaking directly to our specially trained technicians. The technician records the data transmitted from your machine and uses it to analyze the issue, providing a fast and effective diagnosis.

If you experience problems with your washer, call 1-800-243-0000 (1-888-542-2623 in Canada). Only use the Smart Diagnosis System feature when instructed to do so by the Smart Diagnosis Team. The transmission sounds that you will hear are normal and sound similar to a melody.

Smart Diagnosis cannot be activated unless your washing machine is turned on by pressing the POWER button. If your washing machine is unable to turn on, then troubleshooting must be done without using Smart Diagnosis.

USING THE SMART DIAGNOSIS™ SYSTEM

Follow the technician's instructions and perform the following steps when requested.

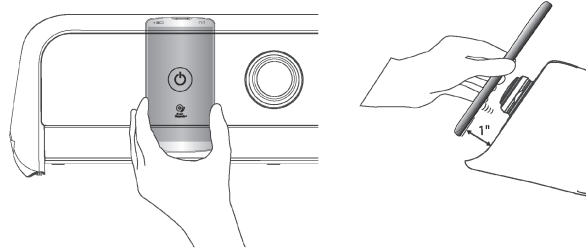

HOLD the mouthpiece of your phone over the power button, when instructed to do so by the call center, no more than one inch from (but not touching) the machine.

NOTE: Do not press any other buttons or turn the cycle selector knob.

PUSH and hold the TEMP. button while continuing to hold your phone to the POWER button.

LISTEN for three beeps. After you hear the three beeps, release the TEMP. button. Keep the phone in place until the tone transmission has finished. This takes about 6 seconds, and the display will count down the time. Once the countdown is over and the tones have stopped, resume your conversation with the technician, who will then be able to assist you in using the information transmitted for analysis.

“SmartDiagnosis is a troubleshooting feature designed to assist, not replace, the traditional method of troubleshooting through service calls. The effectiveness of this feature depends upon various factors, including, but not limited to, the reception of the cellular phone being used for transmission, any external noise that may be present during the transmission, and the acoustics of the room where the machine is located. Accordingly, LG does not guarantee that SmartDiagnosis would accurately troubleshoot any given issue.”

TAG ON FUNCTION

BEFORE USING TAG ON

- The Tag On function allows you to conveniently use the LG Smart Diagnosis™, Cycle Download, Laundry Stats and Tag On Cycle Set features to communicate with your appliance right from your own smart phone.
- To use the Tag On function:
 1. Download the LG Smart Laundry & DW App to your smart phone.
 2. Turn on the NFC (Near Field Communication) function in your smart phone.
- The Tag On function can be used with most smart phones equipped with the NFC function and based on the Android operating system (OS).

TURNING ON THE NFC FUNCTION OF THE SMART PHONE



1. Enter the "Settings" menu of the smart phone and select "Share & Connect" under "WIRELESS & NETWORKS".

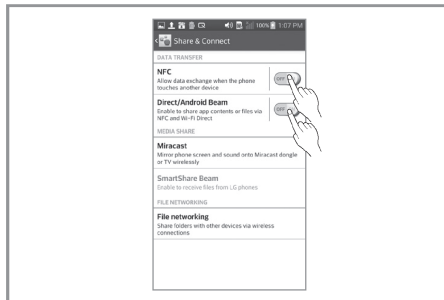

2. Set "NFC" and "Direct/Android Beam" to ON and select "NFC".

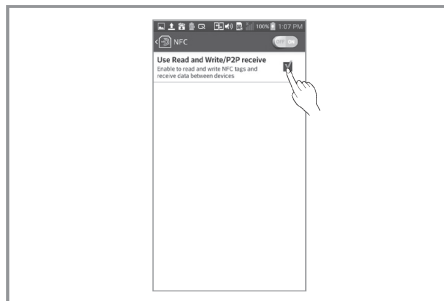

3. Check "Use Read and Write/P2P receive".

NOTE:

- Depending on the smart phone manufacturer and Android OS version, the NFC activation process may differ.
- Refer to the manual of your smart phone for details.

THE TAG ON ICON

Tag On position

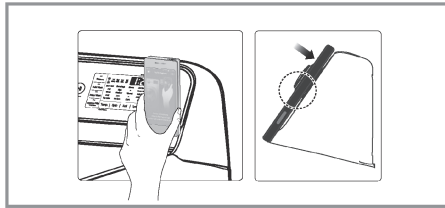
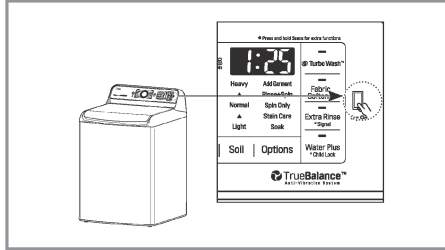

• Tag On Tag On:

Look for the Tag On icon next to the LED screen on the control panel.

This is where you position your smart phone when using the Tag On function with the LG SmartDiagnosis™, Cycle Download, Laundry Stats, Tag On Cycle Set features of the LG Smart Laundry & DW App.

- When you use the Tag On function, position your smart phone so that the NFC antenna on the back of your smart phone matches the position of the Tag On icon on the appliance.

If you do not know the position of your NFC antenna, move your smart phone very slightly in a circular motion until the application verifies the connection.

- To operate NFC function in this machine requires a smart phones which have at least a certain level of NFC recognition function.
- Because of the characteristics of NFC, if the transmission distance is too far, or if there is a metal sticker or a thick case on the phone, transmission will not be good. In some cases, NFC-equipped phones may be unable to transmit successfully.
- Press  in the LG Smart Laundry & DW app for a more detailed guide on how to use the Tag On function.

USING TAG ON

This feature allows you to use LG SMART DIAGNOSIS™, Cycle Download, Laundry Stats, Tag On Cycle Set, and other apps when you touch the LG appliance's Tag On logo with your NFC-equipped smart phone.

TAG ON SELF-DIAGNOSIS USING LG SMART LAUNDRY & DW APPLICATION



1. Install "LG Smart Laundry & DW" application on an NFC-equipped smart phone.
Install the application from the Play store and run it.



2. Select Tag On.
Select "Tag On" by using the top icons or the bottom icons.

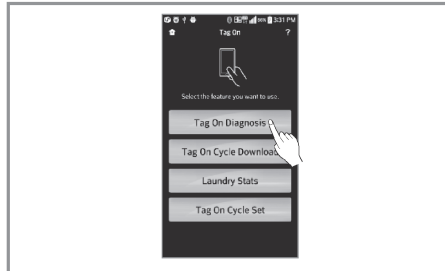

3. Select "Tag On Diagnosis".

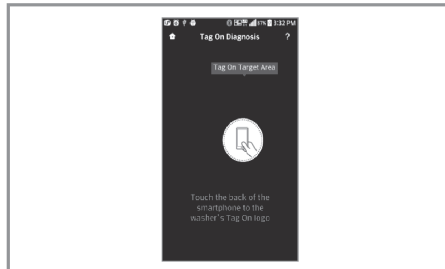

4. Touch the Tag On logo.
When a Tag On screen appears (see at left), tap your smart phone on the Tag On icon on the right side of the washer's control panel.
If it isn't recognized, touch **?** on the upper right of the Tag On screen on your "LG Smart Laundry & DW" app to see the detailed guide.
(This might happen due to the different NFC antenna positions for each phone.)

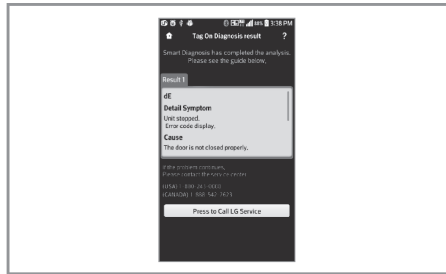

5. Check the diagnosis results and solutions.
It shows the diagnosis results on the cycle recently used.

- Images are for reference only. The LG Smart Laundry & DW application may be updated.

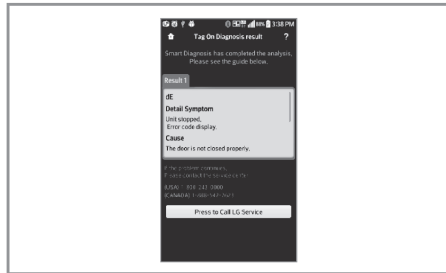

1. Select "Press to Call LG Service" on the Smart Diagnosis Result Screen.

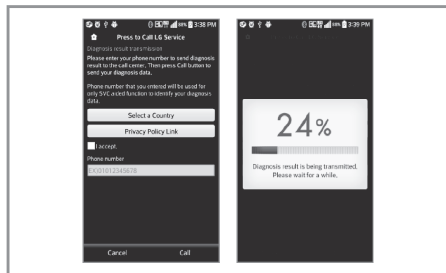

2. Press 'Select a Country' to select your country.
3. Press 'Privacy Policy Link' and check the Terms and Conditions of the Use and Privacy Policy.
4. Press 'I accept.'
5. Enter your phone number in the field. Use this phone number when talking to the LG customer service representative for them to find your Smart Diagnosis data.
6. Press 'Call' button to send your Smart Diagnosis data.



7. When the screen appears as shown on the left, press the call button to connect the LG customer service.

TAG ON CYCLE DOWNLOAD

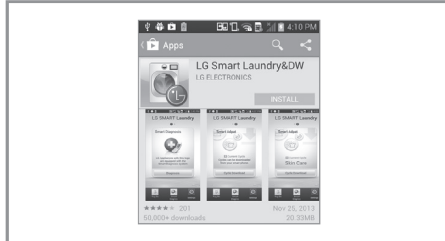

1. Install "LG Smart Laundry & DW" app on an NFC-equipped smart phone.
Install the app from the Play store and run it.



2. Select Tag On.
Select "Tag On" by using the top icons or the bottom icons.

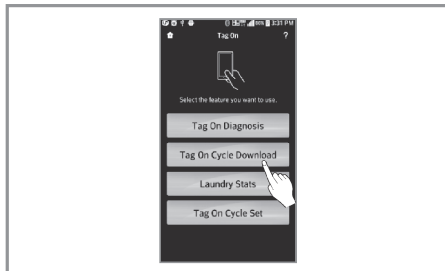

3. Select "Tag On Cycle Download."

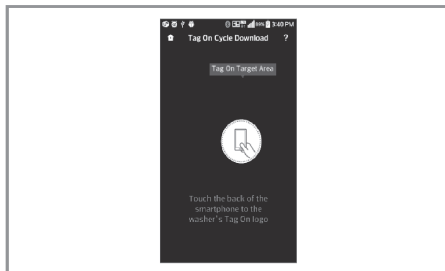

4. Touch the Tag On logo.
When a Tag On screen appears (see at left), tap your smart phone on the Tag On icon on the right side of the washer's control panel.
If it isn't recognized, touch **?** on the upper right of the Tag On screen on your "LG Smart Laundry & DW" app to see the detailed guide.
(This might happen due to the different NFC antenna positions for each phone.)



5. Select a cycle to download.
You can also check the existing cycles already downloaded.

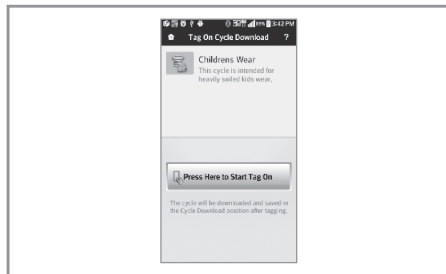

6. Touch the Tag On logo.
When a Tag On screen appears (see at left), tap your smart phone on the Tag On icon on the right side of the washer's control panel.
If it isn't recognized, touch **?** on the upper right of the Tag On screen on your "LG Smart Laundry & DW" app to see the detailed guide.
(This might happen due to the different NFC antenna positions for each phone.)

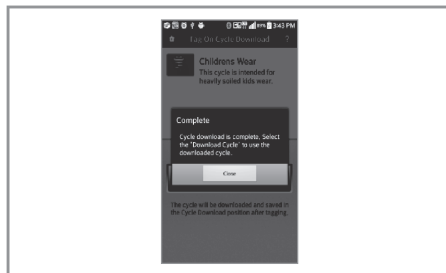

7. The new cycle is downloaded successfully!
Check whether the new cycle is downloaded by turning the cycle selector knob to Downloaded Cycle/ Small Load.

- Images are for reference only.
The LG Smart Laundry & DW application may be updated.

LAUNDRY STATS



1. Select Tag On.
Select "Tag On" by using either the top or bottom icons.

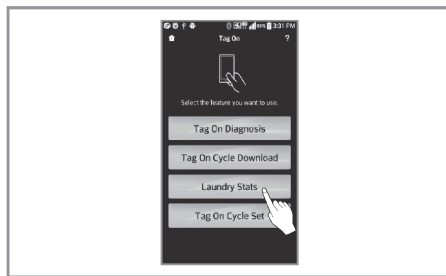

2. Select 'Laundry Stats'.

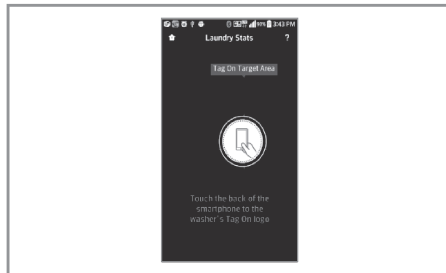

3. Touch the Tag On logo.
When a Tag On screen appears (see at left), tap your smart phone on the Tag On icon on the right side of the washer's control panel.
If it isn't recognized, touch on the upper right of the Tag On screen on your "LG Smart Laundry & DW" app to see the detailed guide.
(This might happen due to the different NFC antenna positions for each phone.)

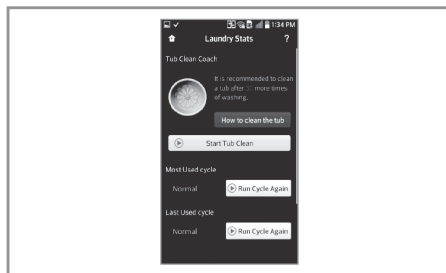

4. Check to see when to run Tub Clean or to select the proper cycle for your laundry.

- Images are for reference only. The LG Smart Laundry & DW application may be updated.

LAUNDRY STATS – TUB CLEAN COACH

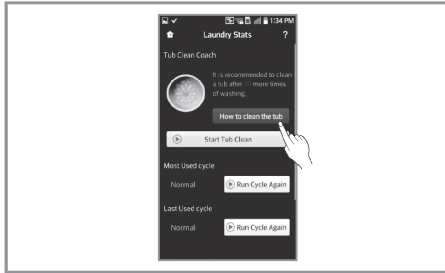

1. Select 'How to clean the tub' on the Laundry Stats screen.

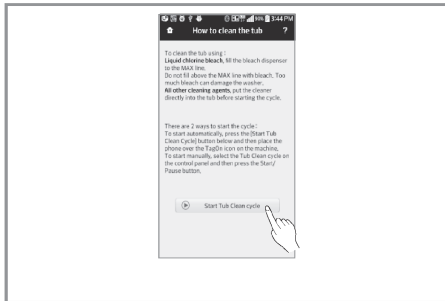

2. Follow the instructions on the phone to see how to prepare the machine for Tub Clean. Select 'Start Tub Clean Cycle' button.

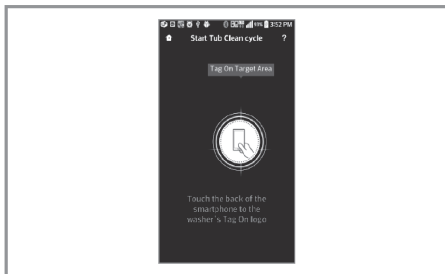

3. Touch the Tag On logo. When a Tag On screen appears (see at left), tap your smart phone on the Tag On icon on the right side of the washer's control panel. If it isn't recognized, touch **?** on the upper right of the Tag On screen on your "LG Smart Laundry & DW" app to see the detailed guide. (This might happen due to the different NFC antenna positions for each phone.)

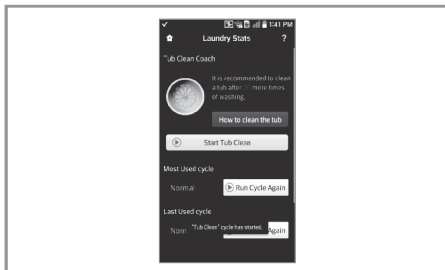

4. Verify that the Tub Clean cycle has begun. The screen at right appears and the Tub Clean cycle begins.

• Images are for reference only. The LG Smart Laundry & DW application may be updated.

LAUNDRY STATS – RUN CYCLE AGAIN

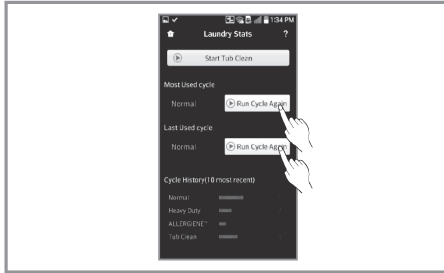

1. Select 'Run Cycle Again' button.

You can check the history of used cycles (10 most recent), the most used cycle, the last used cycle on the screen as shown on the left.

You can start washing immediately on the most used cycle or the last used cycle.

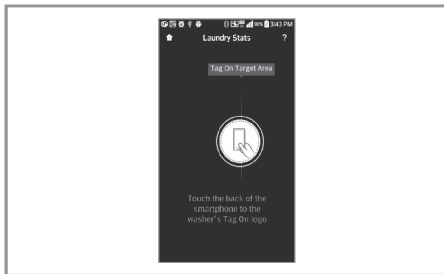

2. Touch the Tag On logo.

When a Tag On screen appears (see at left), tap your smart phone on the Tag On icon on the right side of the washer's control panel.

If it isn't recognized, touch **?** on the upper right of the Tag On screen on your "LG Smart Laundry & DW" app to see the detailed guide.

(This might happen due to the different NFC antenna positions for each phone.)

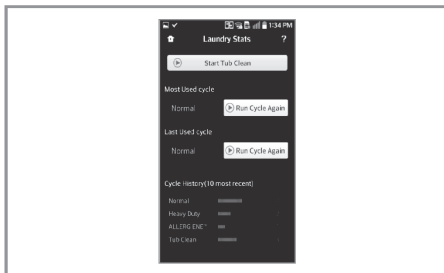

3. Check whether washing starts with the selected cycle.

The screen shown at left appears and washing starts immediately on the selected cycle.

• Images are for reference only.

The LG Smart Laundry & DW application may be updated.

TAG ON CYCLE SET



1. Select Tag On.
Select "Tag On" by using either the top or bottom icons.

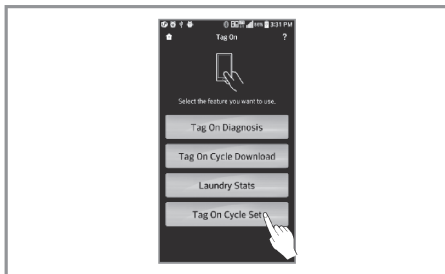

2. Select "Tag On Cycle Set".

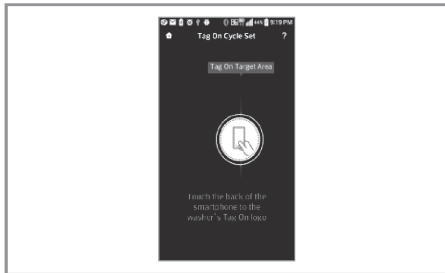

3. Touch the Tag On logo.
When a Tag On screen appears (see at left), tap your smart phone on the Tag On icon on the right side of the washer's control panel.
If it isn't recognized, touch **?** on the upper right of the Tag On screen on your "LG Smart Laundry & DW" app to see the detailed guide.
(This might happen due to the different NFC antenna positions for each phone.)

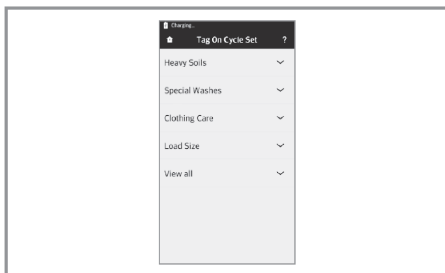

4. Select a laundry category based on the issue you want the machine to focus on.

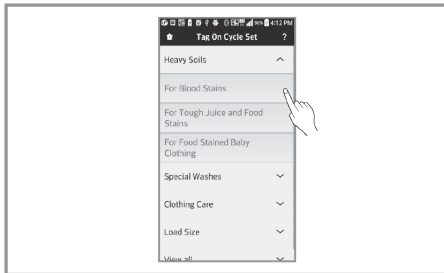

5. After selecting the category, a list of specific cycles will appear. Select the cycle based on your needs.

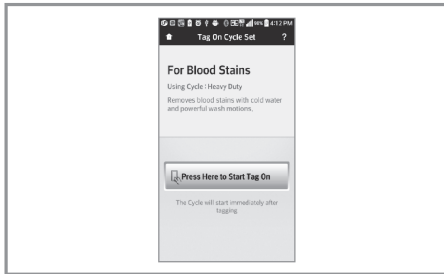

6. Touch the Tag On logo.
When a Tag On screen appears (see at left), tap your smart phone on the Tag On icon on the right side of the washer's control panel. If it isn't recognized, touch  on the upper right of the Tag On screen on your "LG Smart Laundry & DW" app to see the detailed guide. (This might happen due to the different NFC antenna positions for each phone.)

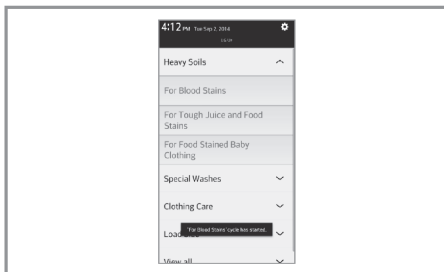

7. After tagging the machine with your phone, the cycle will automatically start. Verify the correct cycle and settings were selected.

- Images are for reference only.
The LG Smart Laundry & DW application may be updated.

TROUBLESHOOTING

NORMAL SOUNDS YOU MAY HEAR

The following sounds may be heard while the washer is operating. They are normal.

CLICKING:

Lid lock relay when the lid locks and unlocks.

SPRAYING OR HISSING:

Water spraying or circulating during the cycle.

HUMMING OR GURGLING:

Drain pump is pumping water from the washer at times during a cycle.

WATER SLOSHING SOUND:

A liquid in the balance ring around the wash basket helps the basket spin smoothly.

SOUND OF WATER BEING ADDED AFTER THE WASHER HAS ALREADY BEEN IN OPERATION

- The washer adapts to the load size and type to add more water to the cycle as needed.
- The wash load may be unbalanced. If the washer senses that the load is unbalanced, it will stop and refill to redistribute the load.
- The washer may be diluting laundry additives to add to the wash load.

BEFORE CALLING FOR SERVICE

Your washing machine is equipped with an automatic error-monitoring system to detect and diagnose problems at an early stage. If your washer does not function properly or does not function at all, check the following before you call for service:

Problem	Possible Cause	Solutions
Rattling and clanking noise	Foreign objects, such as keys, coins, or safety pins may be in tub or pump.	Stop washer, check tub and drain filter for foreign objects. If noise continues after washer is restarted, call for service.
Thumping sound	Heavy wash loads may produce a thumping sound. Wash load may be out of balance.	This is normal. If sound continues, washer is probably out of balance. Stop and redistribute wash load. Pause the cycle and redistribute the load after the lid unlocks.
Vibrating noise	Packaging materials were not removed. Wash load may be unevenly distributed in the tub. Not all leveling feet are resting firmly and evenly on the floor. Floor not rigid enough.	See the Unpacking and Removing Shipping Material section in the installation requirements section. Pause the cycle and redistribute the load after the lid unlocks. See Leveling the Washer in the Installation Instructions section. Make sure that the floor is solid and does not flex. See Flooring in the Installation Requirements section.
Water leaking	Inlet hose connection is loose at faucet or washer. House drain pipes are clogged. Drain hose has come out of drain or is not inserted far enough. A large item such as a pillow or blanket is above the top of the tub.	Check hoses for leaks, cracks and splits. Check and tighten hose connections. The washer pumps out water very rapidly. Check for water backing up out of the drain pipe during drain. If water is seen coming out of the drain, check for proper drain hose installation and check for restrictions in the drain. Contact a plumber to repair drain pipe. Tie drain hose to inlet hose or standpipe to prevent it from coming out during drain. For smaller drain pipes, insert the drain hose into the pipe as far as the drain hose flange. For larger drain pipes, insert the drain hose into the pipe 1-2 inches past the flange. Use the BEDDING cycle for large or bulky items. Use extra care and never wash more than half a load of items that float, such as pillows. Stop the washer and check the load. Make sure the load does not crest above the top edge of the tub.

BEFORE CALLING FOR SERVICE (continued)

ENGLISH

Problem	Possible Cause	Solutions
Wrinkling	Washer not unloaded promptly. Washer overloaded. Hot and cold water inlet hoses are reversed.	Always remove items from the washer as soon as the cycle is complete. The washer can be fully loaded, but the tub should not be tightly packed with items. The lid of the washer should close easily. Hot water rinse can set wrinkles in garments. Check the inlet hose connections.
Excessive sudsing	Too much detergent or incorrect detergent.	HE detergents are formulated specifically for High-Efficiency washers and contain suds-reducing agents. Only use detergent with the High-Efficiency (HE) logo. For detergent quantities refer to the How to Use section.
Staining	Bleach or softener dispensed too soon. Bleach or softener was added directly to the wash load in the tub. Washer was not unloaded promptly. Clothes were not properly sorted.	Dispenser compartment is overfilled causing bleach or softener to dispense immediately. ALWAYS measure bleach to prevent overfilling - one cup maximum. Dispenser drawer closed too quickly causing softener to dispense immediately. Always use the dispensers to ensure that laundry products are properly dispensed at the right time in the cycle. Always remove items from the washer as soon as possible after the cycle is complete. Always wash dark colors separately from light colors and whites to prevent discoloration. Never wash heavily soiled items washed with lightly soiled items.
Washer will not turn ON	Power cord is not properly plugged in. House fuse is blown, circuit breaker has tripped, or power outage has occurred.	Make sure that the plug is plugged securely into a grounded, 3-prong, 120-VAC, 60-Hz outlet. Reset circuit breaker or replace fuse. Do not increase fuse capacity. If the problem is a circuit overload, have it corrected by a qualified electrician.
Wash cycle time is longer than usual	The washer automatically adjusts the wash time for the amount of laundry, water pressure and other operating conditions.	This is normal. The washer adjusts cycle time automatically to provide optimal results for the selected cycle. The time remaining shown in the display is only an estimate. Actual time may vary.
Musty or mildewy odor in washer	Incorrect or too much detergent has been used. Inside of tub was not cleaned properly.	Use only High-Efficiency (HE) detergent in accordance with the manufacturer's instructions. Run the Tub clean cycle regularly.
Water leaks	Oversudsing of detergent.	Oversudsing may create leaks, and may be caused by the type and amount of detergent used. High-Efficiency detergent is the only detergent recommended. Make sure that detergent and any additives are put into the correct dispenser compartments. The normal amount of detergent to use is 1/4 to 1/2 of the maximum amount recommended by the detergent manufacturer. Always reduce the amount of detergent if the load is small or lightly soiled, or if your water is very soft. Never use more than the maximum amount recommended by the detergent manufacturer.

BEFORE CALLING FOR SERVICE (continued)



Problem	Possible Cause	Solutions
Washer will not operate	Control panel has powered off due to inactivity. Washer is unplugged. Water supply is turned off. Controls are not set properly. Lid is open Circuit breaker/fuse is tripped/blown. Control needs to be reset. START/PAUSE was not pressed after a cycle was set. Extremely low water pressure. Washer is too cold.	This is normal. Press the POWER button to turn the washer on. Make sure cord is plugged securely into a working outlet. Turn both hot and cold faucets fully on. Make sure the cycle was set correctly, close the lid and press the START/PAUSE button. The washer will not operate if the lid is open. Close the lid and make sure that nothing is caught under the lid preventing it from closing completely. Check house circuit breakers/fuses. Replace fuses or reset breaker. The washer should be on a dedicated branch circuit. The washer will resume the cycle where it stopped once power is restored. Press the POWER button, then re-select the desired cycle and press the START/PAUSE button. Press the POWER button then re-select the desired cycle and press the START/PAUSE button. The washer will shut off if the START/PAUSE button is not pressed within five minutes. Check another faucet in the house to make sure that household water pressure is adequate. If the washer has been exposed to temperatures below freezing for an extended period of time, allow it to warm up before pressing the POWER button. Otherwise, the display will not come on.
Washer not filling properly	Filter clogged. Inlet hoses may be kinked. Energy efficiency. Insufficient water supply. The washer lid is open. Hot and cold inlet hoses are reversed. Water level is too low.	Make sure the inlet filters on the fill valves are not clogged. Refer to the filter cleaning instructions. Check that inlet hoses are not kinked or clogged. This is a High Efficiency (HE) washer. As a result, the water level settings for this washer may be different than for conventional washers. Make sure that both hot and cold water faucets are turned on all the way. The washer will not operate if the lid is open. Close the lid and make sure that nothing is caught under the lid preventing it from closing completely. Check inlet hose connections. Make sure the hot water supply is connected to the hot inlet valve, and the cold water supply is connected to the cold inlet valve. This is a high efficiency washer. The water will not normally cover the clothes. The fill level is optimized for the wash motion to achieve the best wash performance.

BEFORE CALLING FOR SERVICE (continued)

ENGLISH

Problem	Possible Cause	Solutions
Washer will not drain water	Kinked drain hose. Drain located higher than 96 in. above the floor.	Ensure that the drain hose is not kinked. Make sure that the drain hose is no higher than 8 ft. above the bottom of the washer and is no more than 5 ft. away from the washer.
Poor stain removal	Proper options not selected. Previously set stains.	Heavier soils and tougher stains may require extra cleaning power. Select the Soak or Stain Care feature to boost the cleaning power of the selected cycle. Articles that have previously been washed may have stains that have been set. These stains may be difficult to remove and may require hand washing or pre-treating to aid in stain removal.
Bleach does not dispense	Bleach dispenser cover is not properly installed. Bleach dispenser is dirty or clogged.	Make sure that the bleach cover is properly installed and snapped into place before the beginning of the cycle. Lift out the bleach dispenser cover and clean out the reservoir. Lint and other foreign debris that collects in the inside the dispenser may prevent proper dispensing of the bleach.
Premature dispensing of bleach	Bleach dispenser filled for future load. Overfilling the bleach dispenser.	You cannot store bleach in the dispenser for future use. The bleach will be dispensed every load. Overfilling the bleach dispenser will cause the bleach to dispense immediately, which will damage items in the tub. ALWAYS measure bleach, but never fill above the MAX line on the dispenser. One cup of bleach is normal, but never add more than one cup.
Incomplete or no dispensing of detergent	Detergent compartments clogged from incorrect filling. Too much detergent used. Insufficient water supply. Normal residue.	Make sure that detergent and additives are put into the correct dispenser compartments. If liquid detergent is used, make sure that the liquid detergent cup and insert are in the detergent compartment. If powdered detergent is used, make sure that the liquid detergent cup and insert are not used. For all detergent types, always make sure that the dispenser drawer is fully closed before the start of the cycle. Make sure that the suggested amount of detergent is used per the manufacturer's recommendations. You may also dilute the detergent with water to the maximum fill line on the compartment to avoid clogging. Use only HE (High-Efficiency) detergent. NOTE: Always use as little detergent as possible. High-Efficiency washers need very little detergent to achieve optimum results. Using too much detergent will cause poor wash and rinse performance and may contribute to odors in washer. Make sure that both hot and cold water faucets are turned on all the way. It is normal for a small amount of detergent to remain in the dispenser. If this residue builds up it can interfere with normal dispensing of products. Refer to the cleaning instructions.
Water leaks every load	Hoses not installed correctly.	Check all fill and drain hose connections to ensure that they are tight and secure.

ERROR CODES

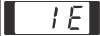
Problem	Possible Cause	Solutions
The display shows: 	The lid is not closed properly.	Make sure that the lid is closed properly and press the START/PAUSE button. After starting a cycle, it may take a few moments before the tub begins to turn or spin. The washer will not spin unless the lid is locked. If the lid is closed and the lid lock error message is displayed, call for service.
The display shows: 	Lid lock switch error.	Make sure that the lid is closed properly and press the START/PAUSE button. The washer will not operate unless the lid is locked. Make sure that nothing is caught under the lid, including shipping material or clothing. Make sure that the latch mechanism is fully retracted. If the lid is closed and the lid lock error message is displayed, call for service.
The display shows: 	Special Drain Feature.	If the washer is paused during a cycle for more than five minutes, the cycle will be cancelled and any water remaining in the tub will be drained.
Washer fills with water slowly or not at all, or the display shows: 	Water supply faucets are not fully open. Water line hoses are kinked, pinched, or crushed. Water inlet filters are clogged. Water supply pressure to faucet or house is too low. Water supply connected with leak-limiting hoses.	Make sure that the water faucets are fully open. Make sure that the hoses are not kinked or pinched. Be careful when moving the washer during cleaning and maintenance. Clean the inlet filters. See Maintenance in the Care and Cleaning section. Check another faucet in the house to make sure that household water pressure is adequate and flow is not restricted. Disconnect the inlet hose from the washer and run a few gallons of water through the hose to flush the water supply lines. If flow is too low, contact a plumber to have the water lines repaired. Hoses designed to limit leaks can trip falsely and prevent the washer from filling. The use of leak limiting hoses is not recommended.
Washer will not turn on	Power cord is not properly plugged in. House fuse is blown, circuit breaker has tripped, or power outage has occurred.	Make sure that the plug is plugged seruely into a grounded, 3-prong, 120-VAC, 60-Hz. outlet. Reset circuit breaker or replace fuse. Do not increase fuse capacity. If the problem is a circuit overload, have it corrected by a qualified electrician.

ERROR CODES (continued)

ENGLISH

Problem	Possible Cause	Solutions
The display shows: LE1	Foreign objects, such as coins, pins, clips, etc., caught between the wash plate and the inner basket.	Turn off the washer and then press the Power button. Press the spin speed button without selecting a cycle to drain and spin the load. When the spin is complete, remove the clothes and then find and remove any objects caught in the wash plate. Always check pockets, etc., before washing to prevent error codes or damage to the washer or clothing.
Water in the washer drains slowly or not at all, or the display shows: DE	Drain hose is kinked, pinched, or clogged Drain discharge is more than 96 inches above bottom of washer.	Make sure the drain hose is free of clogs, kinks, etc., and is not pinched behind or under the washer. Adjust or repair drain. Maximum drain height is 96 inches (8 ft.)
The display shows: ub	The washer has detected an out of balance load.	If the washer detects a load that is too far out of balance to spin, it will display this code while it is attempting to rebalance the load. The washer will add water and try to redistribute the load automatically. This display is for your information only, and no action is required.
The display shows: UE	If the ub rebalance (see above) is not successful, this error will be displayed. The load is too small. Heavy articles are mixed with lighter items. The load is out of balance.	The automatic attempt to rebalance the load was not successful. The cycle has been paused to allow the load to be manually adjusted. Small loads may need additional items to be added to allow the washer to balance the loads. The load may have heavy items loaded with lighter items. Always try to wash articles of somewhat similar weight to allow the washer to evenly distribute the weight of the load for spinning. Manually redistribute the load if articles have become tangled preventing the automatic distribution from working properly.
The display shows: EE	Control error.	Unplug the washer and wait 60 seconds. Reconnect power and try again. If the error reappears, call for service.
The display shows : FE	Water level is too high due to a faulty water valve.	Close the water faucets, unplug the washer, and call for service.
The display shows: PE	The water level sensor is not working correctly.	Close the water faucets, unplug the washer, and call for service.
The display shows: LE	A motor error has occurred.	Allow the washer to stand for 30 minutes and then restart the cycle. If the LE error code persists, call for service.
The display shows: EE	Clutch error.	Mechanical failure. Unplug the washer and call for service.

LG WASHING MACHINE LIMITED WARRANTY (USA)

WARRANTY:

LG Electronics U.S.A., Inc. ("LG") warrants your LG Washing Machine ("product") against defect in materials or workmanship under normal household use, during the warranty period set forth below, LG will, at its option, repair or replace the product. This limited warranty is valid only to the original retail purchaser of the product, is not assignable or transferrable to any subsequent purchaser or user, and applies only when the product is purchased through an LG authorized dealer or distributor and used within the United States ("U.S.") including U.S. Territories.

Note: Replacement products and repair parts may be new or factory-remanufactured and are warranted for the remaining portion of the original unit's warranty period or ninety (90) days, whichever is longer. Please retain dated receipt or delivery ticket as evidence of the Date of Purchase for proof of warranty (you may be required to submit a copy to LG or authorized representative).

WARRANTY PERIOD:

Period	One (1) year from date of original retail purchase:	Ten (10) years from date of original retail purchase:	Lifetime from date of original retail purchase:
Scope of Warranty	Any internal /functional Parts & Labor	Drum Motor (Stator, Rotor, and Hall Sensor)	Stainless Steel Drum
Remark	LG will provide parts & labor to repair or replace defective parts.	Parts only. Customer will be responsible for any labor or in-home service to replace defective parts.	

HOW SERVICE IS HANDLED: In-Home Service

In-home service will be provided, as available, during the warranty period subject to servicer availability within the U.S. To receive in-home service, the product must be unobstructed and accessible to service personnel. If the in-home service repair cannot be completed, it may be necessary to remove, repair and return the product. If in-home service is unavailable, LG may elect, at its option, to provide for transportation of the product to and from an LG authorized service center.

THIS LIMITED WARRANTY DOES NOT COVER:

- Service trips to deliver, pick up, or install the product or for instruction on product use.
- Replacing house fuses or resetting of circuit breakers, correction of house wiring or plumbing, or correction of product installation.
- Damage or failure caused by leaky/ broken/ frozen water pipes, restricted drain lines, inadequate or interrupted water supply or inadequate supply of air.
- Damage or failure caused by accidents, pests and vermin, lightning, wind, fire, floods or acts of God.
- Damage or failure resulting from misuse, abuse, improper installation, repair or maintenance. Improper repair includes use of parts not approved or specified by LG.
- Damage or failure caused by unauthorized modification or alteration to the product.
- Damage or failure caused by incorrect electrical current, voltage, or plumbing codes.
- Cosmetic damage, including scratches, dents, chips or other damage to the finish of the product, unless such damage results from defects in materials or workmanship and is reported to LG within seven (7) calendar days from the date of delivery.
- Damage or missing items to any display, open box, discounted, or refurbished product.
- Product where the original factory serial numbers have been removed, defaced or changed in any way.
- Repairs when product is used in other than normal and usual household use (e.g. rental, commercial use, offices, or recreational facilities) or contrary to the instructions outlined in the owner's manual.
- The removal and reinstallation of the Product if it is installed in an inaccessible location.

THIS WARRANTY IS IN LIEU OF ANY OTHER WARRANTY, EXPRESS OR IMPLIED, INCLUDING AND WITHOUT LIMITATION TO, ANY WARRANTY OF MERCHANTABILITY OR FITNESS FOR A PARTICULAR PURPOSE. TO THE EXTENT ANY IMPLIED WARRANTY IS REQUIRED BY LAW, THIS WARRANTY IS LIMITED IN DURATION TO THE TERM PERIOD EXPRESSED ABOVE. REPAIR OR REPLACEMENT AS PROVIDED UNDER THIS WARRANTY IS THE EXCLUSIVE REMEDY FOR THE CUSTOMER. NEITHER THE MANUFACTURER NOR ITS U.S. DISTRIBUTOR SHALL BE LIABLE FOR ANY INCIDENTAL, CONSEQUENTIAL, INDIRECT, SPECIAL, OR PUNITIVE DAMAGES OF ANY NATURE, INCLUDING AND WITHOUT LIMITATION TO, LOST REVENUES OR PROFITS, OR ANY OTHER DAMAGE, WHETHER BASED IN CONTRACT, TORT, OR OTHERWISE.

SOME STATES DO NOT ALLOW THE EXCLUSION OR LIMITATION OF INCIDENTAL OR CONSEQUENTIAL DAMAGES OR LIMITATIONS ON HOW LONG AN IMPLIED WARRANTY LASTS, SO THE ABOVE EXCLUSION OR LIMITATION MAY NOT APPLY TO YOU. THIS WARRANTY GIVES YOU SPECIFIC LEGAL RIGHTS AND YOU MAY ALSO HAVE OTHER RIGHTS THAT VARY FROM STATE TO STATE.

HOW TO OBTAIN WARRANTY SERVICE & ADDITIONAL INFORMATION:

Write your warranty information below:

Call 1-800-243-0000 or visit our website at www.lg.com
 Mail to: LG Customer Information Center (ATTN: CIC)
 201 James Record Road, Huntsville, AL 35824

Product Registration Information:
 Model:
 Serial Number:
 Date of Purchase:

LG WASHING MACHINE LIMITED WARRANTY (CANADA)

ENGLISH

WARRANTY:

Should your LG Washer ("Product") fail due to a defect in material or workmanship under normal home use during the warranty period set forth below, LG Canada will at its option repair or replace the Product upon receipt of proof of original retail purchase. This warranty is valid only to the original retail purchaser of the product and applies only to a Product distributed in Canada by LG Canada or an authorized Canadian distributor thereof. The warranty only applies to Products located and used within Canada.

Period	One (1) year from the date of original retail purchase	Ten (10) years from the date of original retail purchase	Five (5) years from the date of original retail purchase
Scope of Warranty	Parts and Labor (internal/functional parts only)	DD Motor (Stator, Rotor, Hall Sensor)	Drum Tub Define tub, ie, stainless steel wash tub only
Remark	Washer	Extended Component Warranty (Parts Only) (Consumer will be charged for Labor after one (1) year from the date of purchase)	

- ▶ Replacement products and parts are warranted for the remaining portion of the original warranty period or ninety (90) days, whichever is greater.
- ▶ Replacement products and parts may be new or remanufactured.
- ▶ LG Authorized Service Center warranties their repair work for thirty (30) days.

LG Canada's sole liability is limited to the warranty set out above. Except as expressly provided above, LG Canada makes no and hereby disclaims all other warranties and conditions respecting the product, whether express or implied, including, but not limited to, any implied warranty or condition of merchantability or fitness for a particular purpose, and no representations shall be binding on LG Canada. LG Canada does not authorize any person to create or assume for it any other warranty obligation or liability in connection with the product. To the extent that any warranty or condition is implied by law, it is limited to the express warranty period above. LG Canada, the manufacturer or distributor shall not be liable for any incidental, consequential, special, direct or indirect damages, loss of goodwill, lost profits, punitive or exemplary damages or any other damage, whether arising directly or indirectly from any contractual breach, fundamental or otherwise, or from any acts or omissions, tort, or otherwise. This warranty gives you specific legal rights. You may have other rights which may vary from province to province depending on applicable provincial laws.

Any term of this warranty that negates or varies any implied condition or warranty under provincial law is severable where it conflicts with provincial law without affecting the remainder of this warranty's terms.

This limited warranty does not cover:

1. Service trips to deliver, pick up, or install the product; instructing a customer on operation of the product; repair or replacement of fuses or correction of wiring, or correction of unauthorized repairs/installation.
2. Failure of the product to perform during power failures and interruptions or inadequate electrical service.
3. Damage caused by leaky or broken water pipes, frozen water pipes, restricted drain lines, inadequate or interrupted water supply or inadequate supply of air.
4. Damage resulting from operating the Product in a corrosive atmosphere or contrary to the instructions outlined in the Product owner's manual.
5. Damage to the Product caused by accidents, pests and vermin, lightning, wind, fire, floods, or acts of God.
6. Damage resulting from the misuse, abuse, improper installation, repair, or maintenance of the Product. Improper repair includes use of parts not approved or specified by LG Canada.
7. Damage or product failure caused by unauthorized modification or alteration, or use for other than its intended purpose, or resulting from any water leakage due to improper installation.
8. Damage or Product failure caused by incorrect electrical current, voltage, commercial or industrial use, or use of accessories, components, or cleaning products that are not approved by LG Canada.
9. Damage caused by transportation and handling, including scratches, dents, chips, and/or other damage to the finish of your product, unless such damage results from defects in materials or workmanship and is reported within one (1) week of delivery.
10. Damage or missing items to any display, open box, discounted, or refurbished Product.
11. Products with original serial numbers that have been removed, altered, or cannot be readily determined. Model and Serial numbers, along with original retail sales receipt, are required for warranty validation.
12. Increases in utility costs and additional utility expenses.
13. Replacement of light bulbs, filters, or any consumable parts.
14. Repairs when your Product is used in other than normal and usual household use (including, without limitation, commercial use, in offices or recreational facilities) or contrary to the instructions outlined in the Product owner's manual.
15. Costs associated with removal of the Product from your home for repairs.
16. The removal and reinstallation of the Product if it is installed in an inaccessible location or is not installed in accordance with published installation instructions, including the Product owner's and installation manuals.
17. Accessories to the Product such as lid bins, drawers, handles, shelves, etc. Also excluded are parts besides those that were originally included with the Product.

All costs associated with the above excluded circumstances shall be borne by the consumer.

For complete warranty details and customer assistance, please call or visit our website:

Write your warranty information below:

Call 1-888-542-2623 (24 hours a day, 365 days a year) and select Product Registration Information:
the appropriate option from the menu, or visit our website at <http://www.lg.com>

Model:
Serial Number:
Date of Purchase:

