

This Owner's Manual is provided and hosted by [Appliance Factory Parts](#).



# Norpole NE35R Owner's Manual

[Shop genuine replacement parts for Norpole NE35R](#)



[Find Your Norpole Refrigerator Parts - Select From 78 Models](#)

----- Manual continues below -----

**norpole**<sup>®</sup>  
E-SERIES

# Reach-In Refrigerator / Freezer

## *E-Series*

*User's Manual*

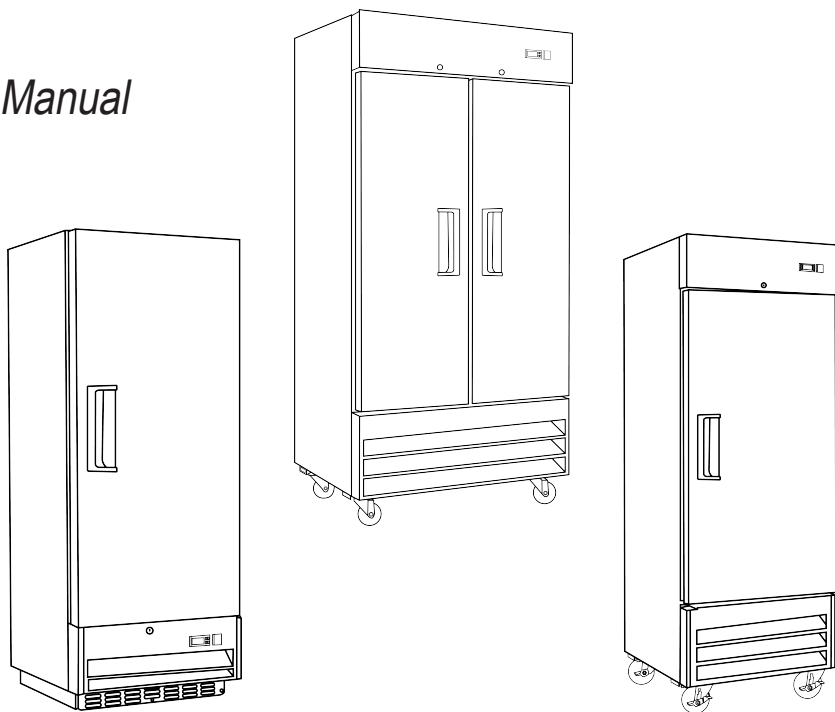

Model NE12R / NE12F / NE19R / NE19F / NE35R / NE35F

**READ THIS MANUAL CAREFULLY BEFORE USING YOUR REACH-IN REFRIGERATOR AND KEEP IT FOR FUTURE REFERENCE.**



## PRODUCT REGISTRATION

Thank you for purchasing a Norpole® product. The first step to protect your new product is to complete the product registration on our website: [www.mcappliance.com/register](http://www.mcappliance.com/register). The benefits of registering your product include the following:

1. Registering your product will allow us to contact you regarding a safety notification or product update.
2. Registering your product will allow for more efficient warranty service processing when warranty service is required.
3. Registering your product could act as your proof of purchase in the event of insurance loss.

Once again, thank you for purchasing a Norpole product.

# CONTENTS

PRODUCT REGISTRATION .....	2
IMPORTANT SAFETY INSTRUCTIONS.....	4
INSTALLATION INSTRUCTIONS .....	5
OPERATING INSTRUCTIONS .....	6
CARE AND MAINTENANCE.....	8
TROUBLESHOOTING .....	9
WARRANTY .....	10

# IMPORTANT SAFETY INSTRUCTIONS

**▲ WARNING:** Hazards or unsafe practices which COULD result in severe personal injury or death.

**▲ CAUTION:** Hazards or unsafe practices which COULD result in minor personal injury or property damage.

1. Read all instructions before using the appliance.
2. **▲ CAUTION:** Installation and maintenance should only be performed by certified professionals. Improper installation could result in serious harm or death and may void your warranty.
3. Any self-modification, improper installation, adjustment or maintenance can lead to property loss or casualty. Please contact customer service for any adjustment or maintenance, and have the work done by a trained & qualified person.
4. To minimize shock and fire hazards, be sure not to overload the outlet or circuit. Please designate one outlet for the unit.
5. **▲ WARNING:** DO NOT insert or pull out the plug with wet hands.
6. The power cord is equipped with a 3-prong grounding plug to protect against shock hazards. ALWAYS plug cord into a properly installed and grounded 3-prong wall receptacle. Refer to the manufactures rating label for electrical and other technical data specific to this unit.
7. DO NOT modify or cut the power cord, or use any other cord or plug. DO NOT use an extension cord.
8. This appliance should not be operated by anyone that is not able to follow proper safety procedures or does not have experience with this type of equipment, unless under close supervision. Keep children away from the device.
9. **▲ WARNING:** DO NOT store anything flammable or explosive in or near the unit.
10. ALWAYS unplug the unit if it is not being used for long periods.
11. ALWAYS unplug the unit for cleaning or maintenance.
12. **▲ WARNING:** DO NOT put your hands or feet under the unit when moving it.
13. **▲ CAUTION:** DO NOT hang on the doors.

READ AND FOLLOW THIS  
SAFETY INFORMATION CAREFULLY  
SAVE THESE INSTRUCTIONS

# INSTALLATION INSTRUCTIONS

**▲ CAUTION:** Read all instructions before installing

- Allow the unit to stand in place at least 24 hours after transporting or moving before plugging it in.
- Make sure that the unit has reached the desired operating temperature before loading product into it.
- Make sure that there is proper ventilation around the unit and in the space in which it will be used.
- Verify that all accessories (shelf clips, shelves, casters, etc.) are correctly installed and in place prior to plugging in.
- Be sure to read the manual in its entirety before using the unit.
- Make sure that the unit is not resting on or against the electrical cord or plug.

## INSTALLATION LOCATION

- Install the unit on a level surface that can support weight of the unit. Uneven surfaces may cause the unit to make noises or not function properly.
- Install in an indoor, well-ventilated area. The unit will function more efficiently with proper ventilation. ALWAYS allow for 4" of clearance in the back of the unit.
- This unit is not intended for outdoor use. Using it outdoors can result in decreased efficiency and may cause the unit to malfunction or become damaged.
- DO NOT install in an area with high humidity or that is very dusty. Humidity can lead to rusting of the components or surfaces, and dust can cause the condenser coil to malfunction. Be sure to clean the condenser regularly, at least once a month, with a brush or clean cloth.
- DO NOT install the unit near any sources of heat or moisture generating equipment. High ambient temperatures can cause the compressor to overwork, leading to higher energy consumption and gradual breakdown of the unit.

**▲ NOTE:** Installing the unit in an improper location or manner may result in failure of the unit, and could void the warranty.

## ELECTRICAL SUPPLY

ALWAYS make sure that the unit is plugged into a properly installed and grounded dedicated outlet that meets the requirements listed on the ratings label and that has appropriate overcurrent protection. Voltage that is too high or too low can detrimentally affect the operation of, or damage, the unit. DO NOT modify or cut the power cord, or use any other plug or an extension cord.

# OPERATION INSTRUCTIONS

## CONTROL PANEL AND DISPLAY

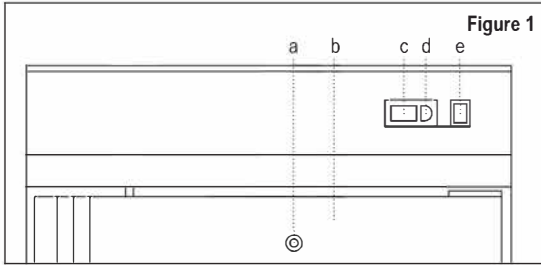

The control panel and display are located at the top or bottom on the right side of the unit, next to the main power switch.

- a. Door Lock
- b. Door
- c. Display
- d. Control Panel
- e. Main Power Switch

▲ **NOTE:** Some units have the Control Panel, Display, and lock on the bottom panel.

## CONTROL PANEL

Button		Normal Operation	
		Pressing the Button Alone	Pressing Buttons Together
	UP ON/OFF	3s: Toggle On/Off	Start/Stop Continuous Cycle
	DOWN DEFROST	3s: Start/Stop Defrost	
	SET MUTE	1s: Display/Set the set point >3s: Access parameter setting menu Mute audible alarm (buzzer)	-

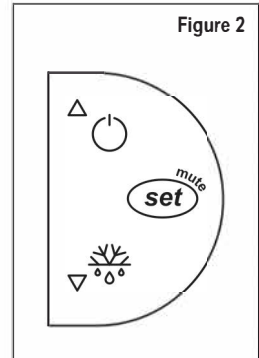

## DISPLAY

Icon	Function	Normal Operation		Start Up
		On	Off	
	Compressor	On	Off	On
	Fan	On	Off	On
	Defrost	On	Off	On
<b>AUX</b>	Aux	Output On	Output Off	On
	Alarm	All	No Alarm	On

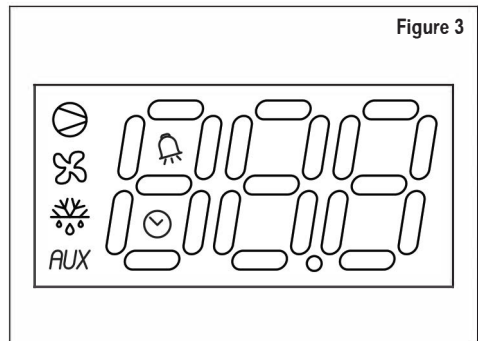

▲ **NOTE:** Not all features and functions are programmed on all models.





▲ **NOTE:** It is not recommended to change the default operating parameters for the temperature and defrost settings, or other advanced settings within the controller. If adjustments to these settings are needed, please contact customer service or a qualified service technician.

## TURNING THE UNIT ON AND OFF

Make sure that the main power switch next to the control panel is in the On position, then press and hold the UP-ON/OFF button (  ) for 3 seconds to turn on or off.

## SETTING THE TEMPERATURE

To adjust the set temperature, follow the instructions below:

1. Press SET (  ) button for 1 second. The set temperature will start flashing after a few moments.
2. Use the UP (  ) or DOWN (  ) buttons increase or decrease the desired temperature setting. The temperature can be set with a range of 33°F (1°C) to 50°F (10°C) for the refrigerators, and -22°F (0°C) to 0°F (-18°C) for the freezers.
3. Press SET (  ) button to confirm the set temperature and save the setting.

The unit will now cool to the set temperature.

**▲ NOTE:** Setting the temperature control too low may result in the evaporator coil building up excessive ice which can lead to the refrigerator not cooling properly.

## DEFROSTING

When the compressor is not running, the evaporator fans continue to circulate air through the evaporator coil, melting accumulated frost. The water will drain into a drain pan to be evaporated. There is also an automatic electric defrost system to keep ice from building up on the cooling system. The defrost cycle is set to operate for a preset amount of time at preset intervals. To manually start a defrost cycle, press and hold the DOWN-DEFROST button (  ) for 3 seconds.

**▲ NOTE:** Opening the door often, or for long periods can cause excessive ice buildup and higher temperatures in the cabinet, and should be avoided.

**▲ NOTE:** The manual defrost will only happen if the temperature is within the defrost parameters.

## CONTINUOUS CYCLE

To set the unit to run in a continuous cycle, press the UP (  ) or DOWN (  ) buttons simultaneously for 3 seconds.

**▲ NOTE:** It is not recommended to put the unit into the Continuous Cycle mode as doing so may result in the evaporator coil building up excessive ice which can lead to the refrigerator not cooling properly.

## LOADING PRODUCT

Before loading product onto the pre-installed shelves, make sure that all the shelf clips are securely fastened, and that the shelves are stable and level. In order to maintain proper airflow in the refrigerator, be sure to leave 2-4" of clearance between the back wall and product stored in the unit. Blocking the evaporator fans may result in the cabinet not cooling properly, and can lead to compressor failure. Always allow the unit to cool down to the set temperature before loading product into it.

**▲ NOTE:** After unplugging the unit, ALWAYS wait at least 10 minutes before plugging it back in. Failure to do so could result in damage to the compressor.

# CARE AND MAINTENANCE

## CLEANING THE CONDENSER COIL

For efficient operation, it is important that the condenser surface be kept free of dust, dirt, and lint. It is recommended to clean the condenser coil and the fins at least once per month.

Remove the screws holding the vent cover at the bottom of the unit in the front (see Figure 4) to access the condenser.

Use a commercial condenser coil cleaner, available from any kitchen equipment retailer. Brush the condenser fins from top to bottom, not side to side. After cleaning, straighten any bent condenser fins with a fin comb.

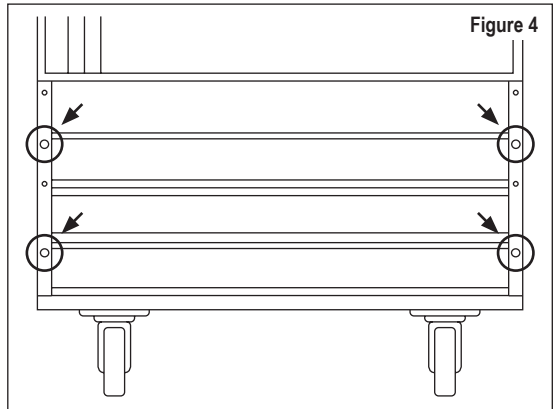

## CLEANING THE FAN BLADES AND MOTOR

If necessary, clean the fan blades and motor with a soft cloth. When washing the fan blades, be sure to cover the fan motor to prevent moisture damage.

## CLEANING THE INTERIOR

When cleaning the cabinet interior, use a solvent of warm water and mild soap. DO NOT use steel wool, abrasive cleaners, caustic soap or bleach as those may damage the surfaces.

Door gaskets should be washed on a weekly basis. Simply remove the door gasket from the frame of the door, soak in warm water and soap for 30 minutes, dry with a soft cloth, and replace on the door. Be sure to check that they are properly sealing after they are replaced.

Periodically remove the shelves and pilasters from the unit and clean them with mild soap and warm water. To remove the pilasters, first remove the shelves and shelf brackets, and then simply lift the pilaster up and out.

**▲ WARNING:** ALWAYS disconnect the power cord before cleaning any parts of the unit.

# TROUBLESHOOTING

Before requesting any service on your unit, please check the following points.

Symptom	Possible Cause	Corrective Action
Compressor not running.	Fuse blown or circuit breaker tripped.	Replace fuse or reset circuit breaker.
	Power cord unplugged.	Plug in power cord.
	Thermostat set too high.	Set thermostat to lower temperature.
	Cabinet in defrost cycle.	Wait for defrost cycle to finish.
Condensing unit runs for long periods of time.	Excessive amount of warm product placed in unit.	Allow adequate time for product to cool down.
	Prolonged door opening or door ajar.	Ensure doors are closed when not in use. Avoid opening doors for long periods of time.
	Door gasket(s) not sealing properly.	Ensure gaskets are properly in place. Remove gasket and clean with soap and water. Check condition of gasket, replace if necessary.
	Dirty condenser coil.	Clean the condenser coil.
	Evaporator coil iced over.	Unplug the unit and allow coil to defrost. Make sure thermostat is not set too cold. Ensure that door gaskets are sealing properly.
Cabinet temperature is too warm.	Thermostat set too warm.	Set thermostat to lower temperature.
	Air flow is blocked.	Re-arrange contents to allow for proper air flow. Make sure to allow at least 4" clearance from the evaporator.
	Excessive amount of warm product placed in unit.	Allow adequate time for product to cool down.
	Fuse blown or circuit breaker tripped.	Replace fuse or reset circuit breaker.
	Dirty condenser coil.	Clean the condenser coil.
	Prolonged door opening or door ajar.	Ensure doors are closed when not in use. Avoid opening doors for long periods of time.
Unit is noisy.	Loose part(s).	Locate and tighten loose part(s).
	Tubing Vibrating.	Ensure that tubing is not contacting other tubing or any other components.

Please note that this guide serves only as a reference for solutions to common problems.



# LIMITED WARRANTY

Norpole, Inc. warrants each new Refrigerator to be free from defects in material and workmanship and agrees to remedy any such defect or to furnish a new part(s) (at the company's option) for any part(s) of the unit that has failed during the warranty period. Parts and labor expenses are covered on this unit for a period of three years from the date of purchase.

In addition, Norpole, Inc. warrants the compressor (parts only) to be free from defects in material and workmanship for a period of 5 years. The consumer is responsible for all labor and transportation expenses related to the diagnosis and replacement of the compressor after the initial three-year warranty expires. In the event that the unit requires replacement or refund under the terms of this warranty, the consumer is responsible for all transportation expenses to return the unit to our factory prior to receiving a replacement unit or refund. A refund or replacement will be issued at the discretion of Norpole, Inc. A copy of the dated sales receipt/invoice is required to receive warranty service or a refund.

This warranty covers appliances in use within the contiguous United States, Alaska, Hawaii and Puerto Rico. The warranty does not cover the following:

- Damages due to shipping damage or improper installation.
- Damages due to misuse or abuse.
- Punctures to the evaporator system due to improper defrosting of the unit.
- Content losses due to failure of the unit.
- Inside components such as the shelves, light bulbs, etc.
- Repairs performed by unauthorized service agents.
- Service calls that do not involve defects in material and workmanship, such as instructions on proper use of the product or improper installation.
- Replacement or resetting of fuses or circuit breakers.
- Failure of this product if used for purposes other than its intended purpose.
- Disposal costs for any failed unit not returned to our factory.
- Any delivery or installation costs incurred as the result of a unit that fails to perform as specified.
- Expenses for travel and transportation for product service if your appliance is located in a remote area where service by an authorized service technician is not available.
- The removal and reinstallation of your appliance if it is installed in an inaccessible location or is not installed in accordance with published installation instructions.
- Refunds for non-repairable products are limited to the price paid for the unit per the sales receipt or invoice.
- This warranty is non-transferable. This warranty applies only to the original purchaser and does not extend to any subsequent owners.

## LIMITATIONS OF REMEDIES AND EXCLUSIONS

Product repair in accordance with the terms herein, is your sole and exclusive remedy under this limited warranty. Any and all implied warranties including merchantability and fitness for a particular purpose are hereby limited to three years or the shortest period allowed by law. Norpole, Inc. is not liable for incidental or consequential damages and no representative or person is authorized to assume for us any other liability in connection with the sale of this product. Under no circumstances is the consumer permitted to return this unit to the factory without the prior written consent of Norpole, Inc.

Some states prohibit the exclusion or limitation of incidental or consequential damages, or limitations on implied warranties. This warranty gives you specific legal rights, and you may also have other rights which vary from state to state.

<b>Model</b>	<b>Parts &amp; Labor</b>	<b>Compressor (Part Only)</b>	<b>Type of Service</b>
NE12R	1 Year	5 Years	In-Field
NE12F	1 Year	5 Years	In-Field
NE19R	1 Year	5 Years	In-Field
NE19F	1 Year	5 Years	In-Field
NE35R	1 Year	5 Years	In-Field
NE35F	1 Year	5 Years	In-Field

For Service or Assistance please call **888-775-0202** or visit us on the web at **www.mcappliance.com**.