

TOSHIBA

MICROWAVE SOLO OVEN INSTRUCTION MANUAL

ML2-EM09PA(BS)

Please review this instruction manual before operating.

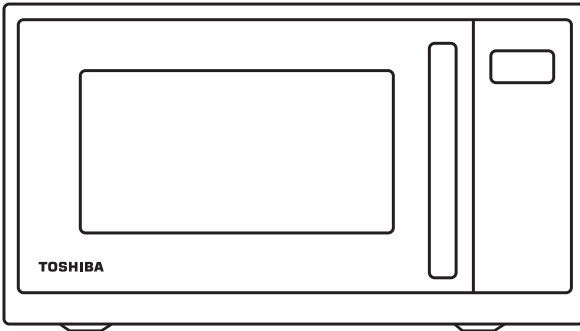

CONTENTS

PRODUCT SAFETY

| | |
|--|-------|
| Precautions to avoid possible exposure to excessive microwave energy | EN-01 |
| Important safety instructions | EN-03 |
| Grounding instructions..... | EN-07 |
| Radio interference | EN-09 |
| Containers..... | EN-10 |
| Materials you can use in microwave oven | EN-11 |
| Materials can not be used in microwave oven | EN-13 |

PRODUCT SETTING

| | |
|----------------------------|-------|
| Setting up your oven | EN-14 |
|----------------------------|-------|

INSTRUCTION FOR USE

| | |
|---------------------------------------|--------------|
| Before using for the first time | EN-18 |
| Operation | EN-19 |
| 1. Power levels..... | EN-20 |
| 2. Clock setting..... | EN-20 |
| 3. Kitchen timer | EN-21 |
| 4. Microwave cook | EN-21 |
| 5. One touch start | EN-23 |
| 6. Time defrost function..... | EN-23 |
| 7. Weight defrost function | EN-24 |
| 8. Popcorn..... | EN-24 |
| 9. Potato | EN-25 |
| 10. Pizza | EN-25 |

| | |
|--|-------|
| 11. Frozen vegetable..... | EN-25 |
| 12. Beverage | EN-26 |
| 13. Dinner plate | EN-26 |
| 14. Memory function..... | EN-26 |
| 15. Mute function..... | EN-27 |
| 16. Multi-stage cooking | EN-28 |
| 17. Energy saver mode..... | EN-29 |
| 18. Lock function..... | EN-29 |
| 19. Inquiring function..... | EN-29 |
| 20. Cooking end reminder function..... | EN-30 |
| 21. Other specifications | EN-30 |
| Cleaning..... | EN-31 |

MAINTENANCE

| | |
|---------------------------------|-------|
| Trouble shooting | EN-33 |
| One year limited warranty | EN-35 |



NOTE

BEFORE OPERATING THIS PRODUCT, READ, UNDERSTAND, AND FOLLOW THESE INSTRUCTIONS. BE SURE TO SAVE THIS BOOKLIST FOR FUTURE REFERENCE.

PRODUCT SAFETY

PRECAUTIONS TO AVOID POSSIBLE EXPOSURE TO EXCESSIVE MICROWAVE ENERGY

- (a). Do not attempt to operate this oven with the door open since this can result in harmful exposure to microwave energy. It is important not to defeat or tamper with the safety interlocks.
- (b). Do not place any object between the oven front face and the door or allow soil or cleaner residue to accumulate on sealing surfaces.
- (c). Do not operate the oven if it is damaged. It is particularly important that the oven door closes properly and that there is no damage to the:
 - (1). DOOR (bent)
 - (2). HINGES AND LATCHES (broken or loosened)
 - (3). DOOR SEALS AND SEALING SURFACE
- (d). The oven should not be adjusted or repaired by anyone except properly qualified service personnel.

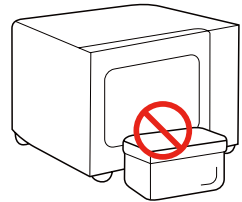

SPECIFICATIONS

| | |
|--------------------------------|-------------------------|
| MODEL | ML2-EM09PA(BS) |
| RATED VOLTAGE | 120V~ 60Hz |
| RATED INPUT POWER (MICROWAVE) | 1350W |
| RATED OUTPUT POWER (MICROWAVE) | 900W |
| OVEN CAPACITY | 0.9 cu.ft. |
| NET WEIGHT | Approx. 28.7 lbs |
| EXTERNAL DIMENSIONS | 19.2 x 15.9 x 11.5 inch |



NOTE

All pictures in this manual are for illustrative purposes only; these may be slightly different from the purchased equipment, please refer to the actual product.

IMPORTANT SAFETY INSTRUCTIONS



WARNING

When using electrical appliances basic safety precautions should be followed, including the following.

To reduce the risk of burns, electric shock, fire, injury to persons or exposure to excessive microwave energy.



Read all instructions before using the appliance.



Read and follow the specific:
"PRECAUTIONS TO AVOID POSSIBLE EXPOSURE TO EXCESSIVE MICROWAVE ENERGY" found on page 1.



This appliance must be grounded. Connect only to properly grounded outlet. See "**GROUNDING INSTRUCTIONS**" found on page 7.



Install or locate this appliance only in accordance with the provided installation instructions.



As with any appliance, close supervision is

necessary when used by children.



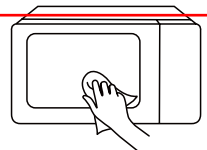

When cleaning surfaces of door and oven that comes together on closing the door, use only mild, nonabrasive soaps, or detergent applied with a sponge or soft cloth.

Please keep the wave guide area clean. Use soft damp cloth to clean it up when there is food splash residue on the wave guide area or the cavity. Failure to clean food residue may cause innocuous sparking or some smoke in the microwave cavity, discoloration of the cavity may also occur.



IMPORTANT SAFETY INSTRUCTIONS

 Keep cord away from heated surface.

 Liquids, such as water, coffee, or tea are able to overheat beyond the boiling point without appearing to be boiling. Visible bubbling or boiling when the container is removed from the microwave oven is not always present.

THIS COULD RESULT IN VERY HOT LIQUID SUDDENLY BOILING OVER WHEN THE CONTAINER IS DISTURBED OR A UTENSIL IS INSERTED INTO THE LIQUID. To reduce the risk of injury to persons:

1. Do not overheat the liquid.
2. Stir the liquid both before and halfway through heating it.
3. Do not use straight-sided containers with narrow necks.

4. After heating, allow the container to stand in the microwave oven for a short time before removing the container.
5. Use extreme care when inserting a spoon or other utensil into the container.

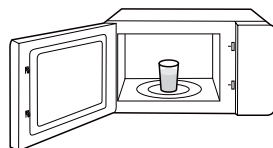

 This appliance should be serviced only by qualified service personnel. Contact nearest authorized service facility for examination, repair, or adjustment.

 To reduce the risk of fire in the oven cavity:

1. Do not overcook food. Carefully attend appliance when paper, plastic, or other combustible materials

IMPORTANT SAFETY INSTRUCTIONS

are placed inside the oven to facilitate cooking.

2. Remove wire twist-ties from paper or plastic bag before placing bag in oven.
3. If material inside of the oven ignite, keep oven door closed, turn oven off, and disconnect the power cord, or shut off power at the fuse or circuit breaker panel.
4. Do not use the cavity for storage purposes. Do not leave paper products, cooking utensils, or food in the cavity when not in use.

-  Some products such as whole eggs and sealed containers, for example, closed glass jars are able to explode and should not be heated in this oven.

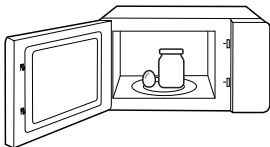

-  Do not store this appliance outdoors. Do not use this product near water - for example, near a kitchen sink, in a wet basement, near a swimming pool, or similar location.

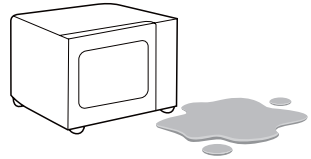



-  Do not immerse cord or plug in water or any other liquid.



-  Use this appliance only for its intended use as described in the manual. Do not use corrosive chemicals or vapors in this appliance. This type of oven is specifically designed to heat, cook or dry food. It is not designed for industrial or laboratory use.

IMPORTANT SAFETY INSTRUCTIONS

 Do not operate this appliance if it has a damaged cord or plug, if it is not working properly, or if it has been damaged or dropped.

 Do not cover or block any openings on the appliance.

 Do not let cord hang over edge of table or counter.

SAVE THESE INSTRUCTIONS

HOUSEHOLD USE ONLY(NOT FOR COMMERCIAL USE)

GROUNDING INSTRUCTIONS

This appliance must be grounded. In the event of an electrical short circuit, grounding reduces the risk of electric shock by providing an escape wire for the electric current. This appliance is equipped with a cord having a grounding wire with a grounding plug. The plug must be plugged into an outlet that is properly installed and grounded.

WARNING - Improper use of the grounding can result in a risk of electric shock. Consult a qualified electrician or serviceman if the grounding instructions are not completely understood, or if doubt exists as to whether the appliance is properly grounded. If it is necessary to use an extension cord, use only a 3-wire extension cord that has a 3-blade grounded plug, and 3-slot receptacle that will accept the plug on the appliance. The marked rating of the extension cord shall be equal to or greater than the electrical rating of the appliance.



Electric Shock Hazard:

Touching some of the internal components can cause serious personal injury or death. Do not disassemble this appliance.

GROUNDING INSTRUCTIONS

Electric Shock Hazard:

Improper use of the grounding can result in electric shock. Do not plug into an outlet until appliance is properly installed and grounded.

1. A short power-supply cord is provided to reduce the risks resulting from becoming entangled in or tripping over a longer cord.
2. Longer cord sets or extension cords are available and may be used if care is exercised in their use.
3. If a long cord or extension cord is used:
 - (1). The marked electrical rating of the cord set or extension cord should be at least as great as the electrical rating of the appliance.
 - (2). The extension cord must be a grounding-type 3-wire cord.
 - (3). The longer cord should be arranged so that it will not drape over the counter top or tabletop where it can be pulled on by children or tripped over unintentionally.



WARNING

RADIO INTERFERENCE

1. Operation of the microwave oven may cause interference to your radio, TV or similar equipment.
2. When there is interference, it may be reduced or eliminated by taking the following measures:
 - (1).Clean door and sealing surface of the oven.
 - (2).Reorient the receiving antenna of radio or television.
 - (3).Relocate the microwave oven with respect to the receiver.
 - (4).Move the microwave oven away from the receiver.
 - (5).Plug the microwave oven into a different outlet so that microwave oven and receiver are on different branch circuits.

**This device complies
with part 18 of the FCC
Rules.**

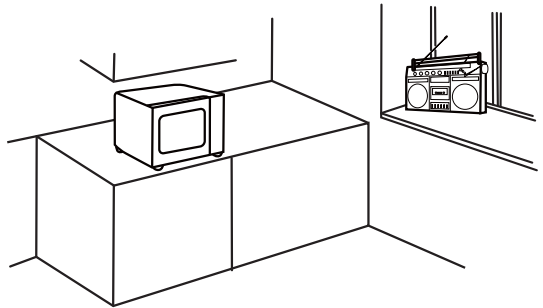

CONTAINERS



Personal Injury Hazard:

Tightly-closed utensils could explode. Closed containers should be opened and plastic pouches should be pierced before cooking.

See the instructions on "**Materials you can use in microwave oven**" or "**Materials can not be used in microwave oven.**"

There may be certain non-metallic utensils that are not safe to use for microwaving. If in doubt, you can test the utensil in question following the procedure below.

Utensil Test:



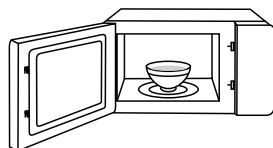



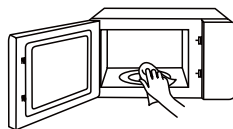









1. Fill a microwave-safe container with 1 cup of cold water (250ml) along with the utensil in question.
2. Cook on maximum power for 1 min.
3. Carefully feel the utensil. If the empty utensil is warm, do not use it for microwave cooking.
4. Do not exceed 1 min cooking time.











KEEP THE CAVITY CLEAN

















MATERIALS YOU CAN USE IN MICROWAVE OVEN

| UTENSILS | REMARKS |
|--|--|
|  Browning dish | Follow manufacturer's instructions. The bottom of browning dish must be at least 3/16 inch (5mm) above the turntable. Incorrect usage may cause the turntable to break.  |
|  Dinnerware | Microwave-safe only. Follow manufacturer's instructions. Do not use cracked or chipped dishes.  |
|  Glass jars | Always remove lid. Use only to heat food until just warm. Most glass jars are not heat resistant and may break.  |
|  Glassware | Heat-resistant oven glassware only. Make sure there is no metallic trim. Do not use cracked or chipped dishes.  |
|  Oven cooking bags | Follow manufacturer's instructions. Do not close with metal tie. Make slits to allow steam to escape.  |
|  Paper plates and cups | Use for short-term cooking/warming only. Do not leave oven unattended while cooking.  |
|  Paper towels | Use to cover food for reheating and absorbing fat. Use with supervision for a short-term cooking only.  |
|  Parchment paper | Use as a cover to prevent splattering or a wrap for steaming.  |

MATERIALS YOU CAN USE IN MICROWAVE OVEN

| UTENSILS | REMARKS |
|---|---|
|  <p data-bbox="169 454 240 478">Plastic</p> | <p data-bbox="349 359 900 494">Microwave-safe only. Follow the manufacturer's instructions. Should be labeled "Microwave Safe". Some plastic containers soften, as the food inside gets hot. "Boiling bags" and tightly closed plastic bags should be slit, pierced or vented as directed by package.</p>  |
|  <p data-bbox="147 638 262 662">Plastic wrap</p> | <p data-bbox="349 558 900 638">Microwave-safe only. Use to cover food during cooking to retain moisture. Do not allow plastic wrap to touch food.</p>  |
|  <p data-bbox="131 805 278 829">Thermometers</p> | <p data-bbox="349 750 889 774">Microwave-safe only (meat and candy thermometers).</p>  |
|  <p data-bbox="152 965 256 989">Wax paper</p> | <p data-bbox="349 901 819 949">Use as a cover to prevent splattering and retain moisture.</p>  |

MATERIALS CAN NOT BE USED IN MICROWAVE OVEN

| UTENSILS | REMARKS |
|--|--|
|  <p>Aluminum tray</p> | May cause arcing. Transfer food into microwave-safe dish.  |
|  <p>Food carton with metal handle</p> | May cause arcing. Transfer food into microwave-safe dish.  |
|  <p>Metal or metal trimmed utensils</p> | Metal shields the food from microwave energy. Metal trim may cause arcing.  |
|  <p>Metal twist ties</p> | May cause arcing and could cause a fire in the oven.  |
|  <p>Paper bags</p> | May cause a fire in the oven.  |
|  <p>Plastic foam</p> | Plastic foam may melt or contaminate the liquid inside when exposed to high temperature.  |
|  <p>Wood</p> | Wood will dry out when used in the microwave oven and may split or crack.  |

SETTING UP YOUR OVEN

NAMES OF OVEN PARTS AND ACCESSORIES

Throughout this manual, features and appearance may vary from your model. Remove the oven and all materials from the carton and oven cavity. Your oven comes with the following accessories:

| | |
|--------------------|---|
| Glass tray | 1 |
| Turntable ring | 1 |
| Instruction Manual | 1 |

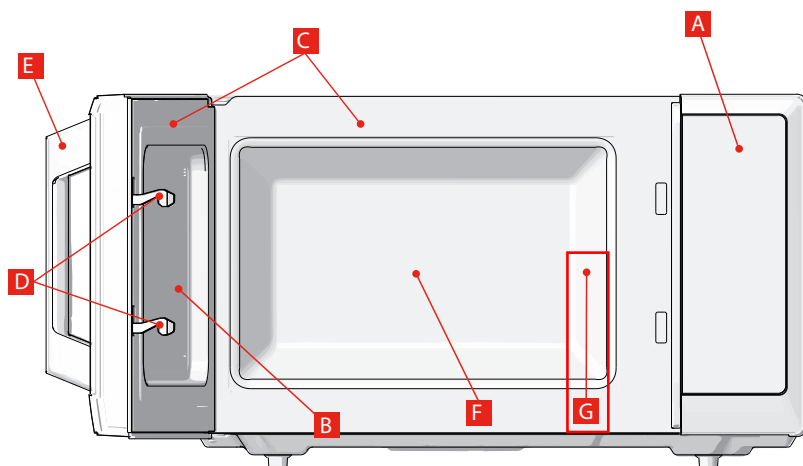

- A** Control panel — The pads used to operate the oven are located on the control panel.
- B** Observation window — Allows cooking to be viewed while keeping microwaves confined in the oven.
- C** Door seals and sealing surfaces — The oven will not operate unless the door is securely closed.
- D** Safety interlock system — The door must be securely latched for the oven to operate.
- E** Door handle
- F** Oven cavity
- G** Waveguide cover

SETTING UP YOUR OVEN

TURNTABLE INSTALLATION

Cleaning the cooking compartment and putting the turntable in place. For new installations, make sure all packaging and shipping tape has been removed from the turntable shaft. Before using the appliance to prepare food for the first time, you will need to put the turntable in place correctly. You must clean the cooking compartment and accessories.

How to put the turntable in place:

1. Place the roller ring **b** into the recess in the cooking compartment.
2. Place the glass tray **a** on the Turntable ring. Fit the raised, curved lines in the center of the glass tray bottom between the three spokes of the shaft. Make sure that the turntable engages in the turntable shaft **c** in the centre of the cooking compartment floor. The rollers on the shaft should fit inside the turntable bottom ridge.

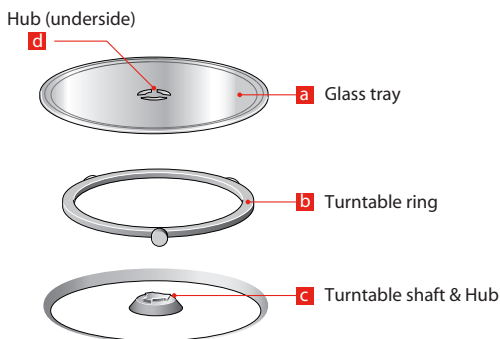

- Never use the appliance without the turntable. Make sure that it is properly engaged. The turntable can turn clockwise or anti-clockwise.
- Never place the glass tray upside down. The glass tray should never be restricted.
- Both glass tray and turntable ring assembly must always be used during cooking.
- All food and containers of food are always placed on the glass tray for cooking.
- Never restrict the movement of the turntable.
- If glass tray or turntable ring assembly cracks or breaks, contact your nearest authorized service center.

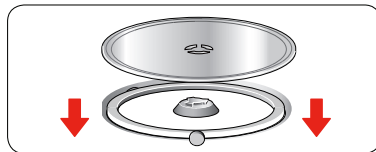
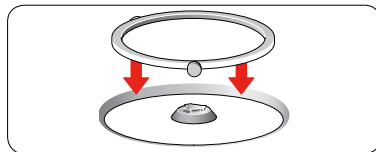
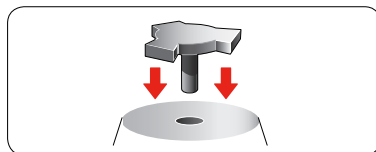

SETTING UP YOUR OVEN

COUNTERTOP INSTALLATION

Remove all packing material and accessories. Examine the oven for any damage such as dents or broken door. Do not install if oven is damaged.

Cabinet: Remove any protective film found on the microwave oven cabinet surface. Do not remove the light brown waveguide cover that is attached to the oven cavity to protect the magnetron.

INSTALLATION

1. Select a level surface that provide enough open space for the intake and/or outlet vents.
 - a. The minimum installation height is 3.0 ft.
 - b. Leave a minimum clearance of 3.0 inches on each side, 3.0 inches on top and 1.0 inch in the rear.
 - c. Do not remove the legs from the bottom of the oven.
 - d. Blocking the intake and/or outlet openings can damage the oven.
 - e. Operation of microwave oven may cause interference to your radio or TV reception.
Please place the oven as far away from radios and TV as possible.

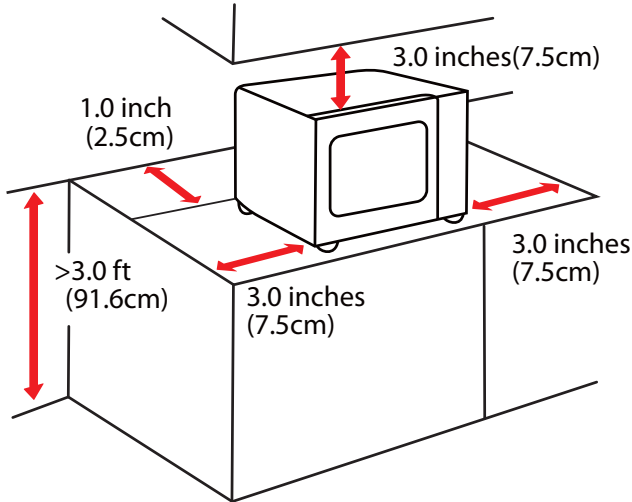

2. Plug microwave oven into a standard household outlet. Be sure the voltage and the frequency is the same as the voltage and the frequency on the rating label.

SETTING UP YOUR OVEN



NOTE

- Do not install oven over a range cooktop or other heat-producing appliance. If installed near or over a heat source, the oven could be damaged and the warranty would be avoided.

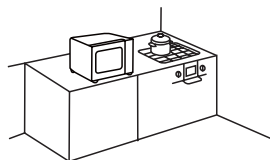

The accessible surface may be hot during operation

CUSTOMER CARE AND SERVICE

THANK YOU FOR MAKING OUR APPLIANCES A PART OF YOUR HOME.

We have created it to give you impeccable performance for many years, Read these instructions carefully. Only then will you be able to operate your appliance safely and correctly. Warning and Important Instructions appearing in this guide are not meant to cover all possible conditions and situations that may occur. Common sense, caution and care must be exercised when installing, maintaining or operating a microwave. Always use original spare parts. Retain the instruction manual and installation instructions for future use or for subsequent owners.

INSTRUCTION FOR USE

BEFORE USING FOR THE FIRST TIME

The appliance may produce unpleasant odors when it is used for the first time.

This section tells you what you need to do before using your microwave to prepare food for the first time. Read the section entitled "**IMPORTANT SAFETY INSTRUCTIONS**" beforehand on page 3.

Before you can use your new appliance, you will need to put the turntable in place correctly. You must also clean the cooking compartment and accessories.



NOTE

- Never use the appliance without the turntable.
- Make sure that it is properly engaged. The turntable can turn clockwise or anti-clockwise.

OPERATION

CONTROL PANEL AND FEATURES



1. POWER LEVELS

Eleven power levels are available.

The power level is automatically set at PL10, but you can change it for more flexibility. Prior to or during cooking, touch Power and then touch number button to choose the power level you wish appears in the display.

If you wish to know power level in cooking state of microwave, simply touch Power, the current power level will be displayed for 3 seconds.

| LEVEL | POWER | DISPLAY |
|-------|-------|---------|
| 10 | 100% | PL10 |
| 9 | 90% | PL9 |
| 8 | 80% | PL8 |
| 7 | 70% | PL7 |
| 6 | 60% | PL6 |
| 5 | 50% | PL5 |
| 4 | 40% | PL4 |
| 3 | 30% | PL3 |
| 2 | 20% | PL2 |
| 1 | 10% | PL1 |
| 0 | 0% | PL0 |

2. CLOCK SETTING

When the microwave oven is plugged into an outlet, "0:00" will display. Oven into standby mode.

- a** Touch "Clock" once, "00:00" will appear in the display.

A rectangular button with rounded corners and a thin border, containing the word "Clock" in a sans-serif font.

- b** Touch the number pads to enter the current clock time.
For example, if the time is now 10:12, enter the correct time of day by touching the numbers "1, 0, 1, 2" in sequence.

A rectangular display area with rounded corners and a thin border. At the top, it says "One Touch Start 1-6 min". Below this, there are three large, spaced-out numbers: "1", "2", and "3".

- c** Touch "Clock" to finish clock setting, ":" will flash and the numbers will appear as a clock time in the display.

A rectangular button with rounded corners and a thin border, containing the word "Clock" in a sans-serif font.





- If the numbers entered are not within the range between 1:00 to 12:59, the setting will not be accepted until valid numbers are entered.
- In the process of setting clock, if the  pad is touched or if there is no operation within 1 minute, the display will automatically return to the previous clock setting.

3. KITCHEN TIMER

- Touch "Timer" once, "00:00" will appear in the display.
- Touch the number pads to enter the time amount. The maximum amount of time that can be entered is 99 minutes, 99 seconds.
- Touch  to confirm setting, and the timer will start to count down.
- When the time amount elapses, the oven will beep 5 times.



- The Kitchen Timer setting is different from the Clock setting; it is simply a timer.
- During the Kitchen Timer function, no cooking function can be set into operation.
- Kitchen Timer amount cannot be increased by touching .
- Touching  will cancel the Timer countdown.

4. MICROWAVE COOK

- a Touch "Cook Time ", "00:00" will appear in the display.



- b Touch number pads to enter the cooking time. The maximum cooking time is 99 minutes, 99 seconds.



- c Touch "Power", PL10 will flash. Touch number pads 0 through 9 to select a different power level if desired. See the POWER LEVELS table above.

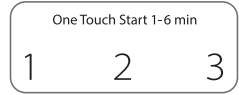

- d Touch  to start cooking. The remaining cooking time will display.



Example : suppose you want to cook the food with 50% microwave power for 15 minutes.

- a Touch "Cook Time ", "00:00" will display.



- b Touch "1, 5, 0, 0" in order for 15:00 to appear in the display.

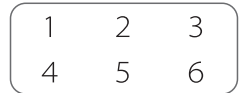

- c Touch Power , then touch "5" to select 50% microwave power.



- d Touch  to start cooking. Buzzer sounds once. The remaining cooking time will display.



NOTE

- In the process of setting, if the  pad is touched or operation within 1 minute, the oven will automatically return to display the clock.
- The power level can be changed during cooking, Touch Power to display current power, then touch the number pad within 3 seconds for the desired power level.

5. ONE TOUCH START

Instant cooking at 100% power level and 1 to 6 minutes cooking time can be started by touching number pads

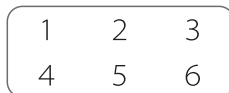

- a 1 to 6. Touch  to increase the cooking time by 30 seconds with each touch. Touch number pads 1 to 6 to increase the corresponding time. The maximum cooking time is 99 minutes, 98 seconds.



 provides a convenient way to extend cooking time by 30 seconds while the oven timer is counting down. It will add 30 seconds to the time shown each time the pad is touched.

- b This pad may also be used as a quick start for 30 seconds of cooking. touch  the oven will start immediately.



- Time can also be added in 30 second increments by touching  during Microwave Cooking, Time Defrost and Multi-stage Cooking.
- Time cannot be added by touching  during Weight Defrost, Kitchen Timer functions and Auto Menus.

6. TIME DEFROST FUNCTION

The microwave oven is pre-programmed with a timer and power levels so that foods such as pork, beef and chicken can be easily defrosted.

- a Touch Time Def., "dEF2" will appear in the display.

Time Def.

- b Touch the number pads to input the defrost time.

1 2 3
4 5 6

The default microwave power is power level 3. If you want to change the power level, touch Power once, and PL3 will display; then touch the number pad within 3 seconds for the desired power level.

c

Power

One Touch Start 1-6 min

1 2 3

- d Touch  to start defrost cooking. And the remaining defrost time will display.



7. WEIGHT DEFROST FUNCTION

The microwave oven is pre-programmed with a timer and power levels so that foods such as pork, beef and chicken can be easily defrosted.

- a Touch Wgt Def. once,"dEF1" will display.

Wgt Def.

- b Touch number pads to input weight to be defrosted.
Input the weight range between 4 to 100 Oz.

| | | |
|---|---|---|
| 1 | 2 | 3 |
| 4 | 5 | 6 |

- c If the weight input is not between 4 to 100 Oz, the input will be invalid. A beep will sound and the unit will not work until valid numbers are entered.

- d Touch  to start defrosting and the cooking time remaining will be displayed.



8. POPCORN

The AUTO MENU automatically calculates the correct cooking mode and cooking time of foods . Follow the example below for details on how to operate this function.

- a Touch "Popcorn" pad repeatedly until the weight number you wish appears in the display, "1.75", "3.0", "3.5" OZ will display in order.

Popcorn

- b Touch  to cook. The remaining time will display. it will signal when cooking finish.





NOTE

- The size of this microwave is ideal for popcorn bags below 85g.
- If you place a larger bag, we suggest you fold it and if the dish does not rotate properly when expanding, touch the  pad once and open the oven door and adjust the position of the bag to ensure even cooking.

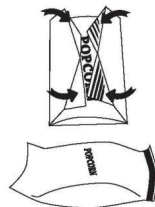

9. POTATO

Touch "Potato" repeatedly until the number you wish appears in the display "1", "2", "3" will display in order.

- a** Touch Once : 1 potato (approx. 8.0 oz)
Touch Twice: 2 potatoes (approx. 16.0 oz)
Touch 3 Times: 3 potatoes (approx. 24.0 oz)

Potato

- b** Touch  to cook. The remaining time will display. it will signal when cooking finish.



10. PIZZA

Touch "Pizza" pad repeatedly until the weight number you wish appears in the display, "4.0", "8.0", "14.0" OZ will display in order.

- a** Touch "Pizza" pad repeatedly until the weight number you wish appears in the display, "4.0", "8.0", "14.0" OZ will display in order.

Pizza

- b** Touch  to cook. The remaining time will display. it will signal when cooking finish.



11. FROZEN VEGETABLE

Touch "Frz. Veggie" pad repeatedly until the weight number you wish appears in the display, "4.0", "8.0", "16.0" OZ will display in order.

- a** Touch "Frz. Veggie" pad repeatedly until the weight number you wish appears in the display, "4.0", "8.0", "16.0" OZ will display in order.

Frz. Veggie

- b Touch  to cook. The remaining time will display. it will signal when cooking finish.



12. BEVERAGE

Touch "Beverage" repeatedly until the number you wish appears in the display "1", "2", "3" will display in order.

- a Touch Once : 1 cup (approx. 120 ml)
Touch Twice: 2 cups (approx. 240 ml)
Touch 3 Times: 3 cups (approx. 360 ml)



- b Touch  to cook. The remaining time will display. It will signal when cooking finish.



13. DINNER PLATE

- a Touch "Dinner" pad repeatedly until the weight number you wish appears in the display, "9.0", "12.0", "18.0" OZ will display in order.



- b Touch  to cook. The remaining time will display. it will signal when cooking finish.



14. MEMORY FUNCTION

Add and save up to 3 of your own speed cook or microwave recipes, Once it's done, you can quickly recall your favorite so that your food cooks just the way you want it quickly!

- a Touch "0/Memory" to program and choose up to three cooking procedures. Each procedure will be indicated by 1, 2 or 3 in the display.



Touch "0/Memory" until your desired procedure number appears in the display. Touch  to begin it. A maximum of two cooking stages can be set for each procedure.



To program a procedure, follow the steps listed below. Example: Cook food at 80% Power Level for 3 minutes and 20 seconds; save as memory 2.

• Touch "0/Memory" twice; screen displays 2.





• Touch "Cook Time", then touch "3", "2" and "0" in order.



• Touch "Power" once, then touch "8" for "PL 8" to display.



• Touch  to save the procedure. Oven beeps once. Or touch  twice directly to save and start cooking.



• To choose the procedure from the memory list, touch "0/Memory" twice. Screen will display "2". Touch  to run procedure.



• Auto Menu cannot be set in Memory function.

15. MUTE FUNCTION

a It is default that the buzzer sounds is open. In standby mode, long touching on numeric pad "8" for 3 seconds, it sounds a long beep, turns off the sound. All the pads has no beep when they are touched, and the ending cooking sounds are off.

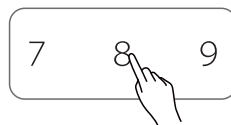

- b When the sounds turn off, long touch on 8 for 3 seconds, it sounds a long beep and the sound turn on.

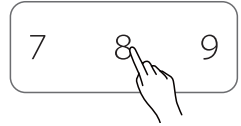

- Mute function can work under lock function.

16. MULTI-STAGE COOKING

Up to two stages of cooking can be set. In multi-stage cooking, the first stage may be microwave and defrosting; if the defrosting program is set in the first stage, only microwave can be set in the second stage. If one of the multiple stages of cooking is defrosting, it is automatically performed in the first stage when cooking starts.

The buzzer sounds after each stage of cooking, and the next stage starts automatically.



- The auto menu can't be used as a stage in a multi-stage cooking.
- Microwave set in the second stage must touch Cook Time to set the cooking time.

EXAMPLE: 80% Power Level for 5 minutes followed by 60% Power Level for 10 minutes.

- Touch "Cook Time", then touch "5", "0" and "0" to set first stage cook time.

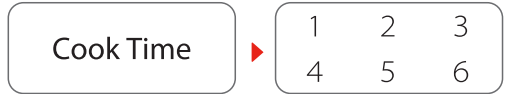

- Touch "Power" once, then touch "8" to choose 80% first stage cooking power.



- Touch "Cook Time" again, then touch "1", "0", "0" and "0" to set second stage cook time.



- Touch "Power" again, then touch "6" to choose 60% second stage cooking power.



- Touch  to immediately start multi-stage cooking.



17. ENERGY SAVER MODE

- a In standby mode, touch the "" once (less than 3 seconds to avoid starting the child lock function) to enter the Energy Saver mode. (The screen turned off automatically when turned on)



- b In child-locked mode, touch the "" once (less than 3 seconds) and release to enter the Energy Saver Mode.



- c Above operation is the only way to start the Energy Saver mode.
- d The Energy Saver mode works only if the door is closed.

- e In screen off, you can touch any pad or open the oven door to turn on the screen, The first touch is to turn on the screen by default, and the second touch is to execution the cooking program itself.

18. LOCK FUNCTION

- a To lock the microwave so that it cannot be operated by children or other unintended users, Touch  pad for 3 seconds. You will hear a long beep. "L L L L" will display.



- b To unlock, touch  for 3 seconds, you will hear a long beep and "L L L L" will disappear.



19. INQUIRING FUNCTION

- a When oven is cooking, touch Clock pad for the time of day to appear for three seconds in the display.



- b When oven is cooking, touch "Power" pad for cooking power to appear for three seconds in the display.

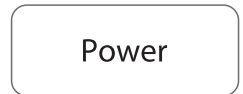

20. COOKING END REMINDER FUNCTION

The oven will beep five times to alert the user that cooking time has ended.

21. OTHER SPECIFICATIONS

- a  must be touched to continue cooking if the door is opened during cooking.



- b A single beep sounds to indicate that a pad is correctly touched; if pad is not correctly touched, no beep sounds.
- c Cooling Fans: at the end of cooking, the automatic fan may continue to run for a short time.
- d When the oven is on, light may be visible around the door or outer case.
- e The turntable must always be in place when using the oven.
- f The clear glass tray should always be in place when microwaving.

CLEANING

With good care and cleaning, your appliance will retain its appearance and remain fully functioning for a long time to come. We will explain here how you should correctly care for and clean your appliance.



WARNING

- Scratched glass in the appliance door may develop into a crack. Do not use a glass scraper, sharp or abrasive cleaning aids or detergents.
- The surface of the appliance may become damaged if it is not cleaned properly. Microwave energy may escape. Clean the appliance on a regular basis, and remove any food remnants immediately.
- Do not immerse the appliance in water or clean under a jet of water.

Cleaning agent

To ensure that the different surfaces are not damaged by using the wrong cleaning agent, observe the information below. Wash new sponge cloths thoroughly before use.

Do not use:



Harsh or abrasive cleaning agents



Metal or glass scrapers to clean the door panels



Metal or glass scrapers to clean the door seal



Hard scouring pads or sponges



Cleaning agents with a high alcohol content

APPLIANCE FRONT

Hot soapy water:

Clean using a dish cloth and then dry with a soft cloth. Do not use metal or glass scrapers for cleaning.

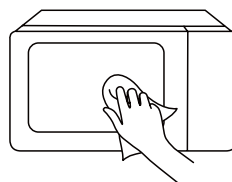

CLEANING

APPLIANCE FRONT PLATE

Hot soapy water:

Clean using a dish cloth and then dry with a soft cloth. Remove splashes and patches of limescale, grease, starch and albumin immediately. Corrosion can form under these patches or splashes. Do not use glass cleaners or metal or glass scrapers for cleaning.

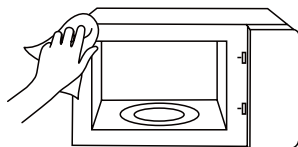

APPLIANCE CAVITY

Hot soapy water or vinegar solution:

Clean using a dish cloth and then dry with a soft cloth. Do not use oven spray or any other aggressive oven cleaners or abrasive materials. Scouring pads, rough sponges and pan cleaners are also unsuitable. These items scratch the surface. Allow the interior surfaces to dry completely.

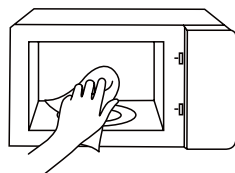

RECESS IN THE COOKING COMPARTMENT

Damp cloth:

Water must not be allowed to run into the appliance through the turntable drive. Dry the turntable drive with a cloth.

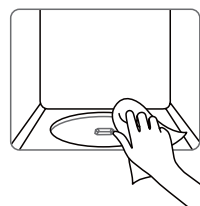

TURNTABLE AND ROLLER RING

Hot soapy water:

When placing the turntable back into its recess, it must engage properly.

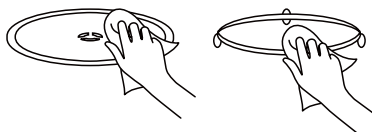

DOOR PANEL

Glass cleaner:

Clean with a dish cloth. Do not use glass scrapers.

MAINTENANCE

TROUBLE SHOOTING

Check your problem by using the chart below and try the solutions for each problem.

| TROUBLE | POSSIBLE CAUSE | POSSIBLE REMEDY |
|-----------------------|--|---|
| Oven will not start | <ul style="list-style-type: none">a. Electrical cord for oven is not plugged in.b. Door is open.c. Wrong operation is set. | <ul style="list-style-type: none">a. Plug into the outlet.b. Close the door and try again.c. Check instructions |
| Arcing or sparking | <ul style="list-style-type: none">a. Materials to be avoided in microwave oven were used.b. The oven is operated when empty.c. Spilled food remains in the cavity. | <ul style="list-style-type: none">a. Use microwave-safe cookware only.b. Do not operate with oven empty.c. Clean cavity with wet towel. |
| Unevenly cooked foods | <ul style="list-style-type: none">a. Materials to be avoided in microwave oven were used.b. Food is not defrosted completely.c. Cooking time, power level is not suitable.d. Food is not turned or stirred. | <ul style="list-style-type: none">a. Use microwave-safe cookware only.b. Completely defrost food.c. Use correct cooking time, power level.d. Turn or stir food. |
| Overcooked foods | Cooking time, power level is not suitable. | Use correct cooking time, power level. |
| Undercooked foods | <ul style="list-style-type: none">a. Materials to be avoided in microwave oven were used.b. Food is not defrosted completely.c. Oven ventilation ports are restricted.d. Cooking time, power level is not suitable. | <ul style="list-style-type: none">a. Use microwave-safe cookware only.b. Completely defrost food.c. Check to see that oven ventilation ports are not restricted.d. Use correct cooking time, power level |
| Improper defrosting | <ul style="list-style-type: none">a. Materials to be avoided in microwave oven were used.b. Cooking time, power level is not suitable.c. Food is not turned or stirred. | <ul style="list-style-type: none">a. Use microwave-safe cookware only.b. Use correct cooking time, power level.c. Turn or stir food. |

TROUBLE SHOOTING

| TROUBLE | POSSIBLE CAUSE | POSSIBLE REMEDY |
|---|--|---|
| Sensor cooked foods not properly cooked | <ul style="list-style-type: none">a. Cover or lid on food not vented.b. Door opened before sensor-detected cooking time appears in display. | <ul style="list-style-type: none">a. Cover or lid over food must contain vent hole for escaping steam.b. Do not open door to stir or turn food before sensor-detected cooking time appears in display. |

ONE YEAR LIMITED WARRANTY

This product carries a warranty stating that it will be free from defects in material and workmanship for a period of one year from the date of purchase. This warranty is valid for the original retail purchaser from the date of initial retail purchase and is not transferable. Keep your original sales receipt.

IMPORTANT:

1. This warranty does not cover damages resulting from accident, misuse or abuse, lack of reasonable care, the affixing of any attachments not provided with the product, loss of parts, or subjecting the appliance to any but the specified voltage. (Read directions carefully.)
2. This warranty is void if this product is ever used for other than private household purposes.
3. This warranty is void if this product is ever used outside of United State.

If service is required during the warranty period, properly pack your unit. We recommend using the original carton and packing materials.

If additional assistance is needed, please contact customer assistance at:

customercare@us.toshiba-lifestyle.com
855-204-5313

Midea America Corp. expressly disclaims all responsibility for consequential damages or incidental losses caused by use of the appliance. Some states do not allow this exclusion or limitation of incidental or consequential losses so the foregoing disclaimer may not apply to you. This warranty gives you specific legal rights, and you may also have other rights which may vary from state to state.

The serial number can be found on the back cabinet. We suggest that you record the serial number of your unit in the space below for future reference

Model Number : _____

Serial Number : _____

Product registration is not mandatory. Failure to complete and return the card or form does not diminish the consumer' s warranty rights.

SAVE THIS FOR YOUR RECORDS

Made in China

#DetailsMatter

Customercare@us.toshiba-lifestyle.com
855-204-5313