

Necessary tools for assembly of your grill is a Phillips head screwdriver. CAUTION: When using a power screwdriver, set it to low torque. Size and type of hardware used in assembly of your grill may vary, but will not affect grill integrity.

"NEW"
T. L. M. - Torque Locking Method

- 1 Screw
- 2 Thru Part
- 3 Formed Locking System

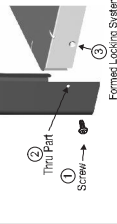

3 Items to Assemble
1 Thru Part
10 Screws

- A Overbrails and hook tabs into slots. Pull rails to latch.
- B Place sure ris on each side of bottom casting.
- C Attach rail and legs with two screws in each corner.



CAUTION: Ends of screws have sharp points

1 Items to Assemble
1 Long Leg Assembly
1 Short Leg Assembly
5 Screws

- A Place bottom shell on table or grill container.
- B Insert tabs on long leg assembly into bottom shell.
- C Attach leg assembly with one screw.
- D Repeat step B and C for short leg assembly.

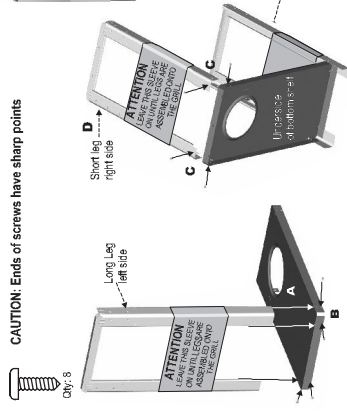

2 Items to Assemble
1 Washer Head Screw
1 U-Nut
1 Tank Thumbscrew
1 Finger Tightener Nut
2 Leg Extensions

- A Attach leg extensions. Check to make sure leg welder is sealed at the way into the leg.
- B Attach U-nut to top. See engagement of U-nut for correct position.
- C Thread tank thumbscrew into hole and U-nut. Turn finger tightener nut onto end of tank.
- D Attach washer head screw to axle rod. Slide wire on axle rod. Insert axle rod/wheel into large hole in bottom shell. Attach other wheel and washer head screw. Note: Hand hold axle rod to tighten washer head screw.

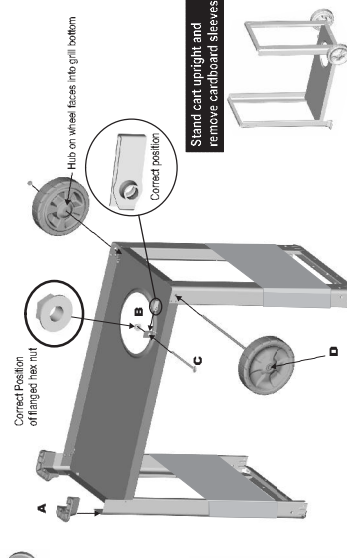
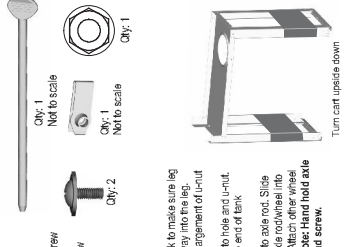

3 Items to Assemble
1 Condiment Basket
1 Push Pin

- A Attach condiment basket to front panel.

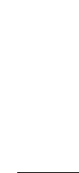

4 Items to Assemble
1 Front Panel
2 Push Pins

- A Place tabs on front panel beside leg tabs.
- B Insert push pins into front panel and legs.

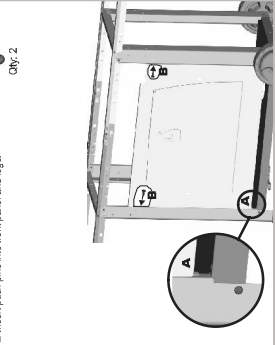

5 Items to Assemble
1 Hose Heat Shield
1 Screw

- A Attach hose heat shield to front panel.



6 Items to Assemble
1 Condiment Basket
1 Push Pin

- A Attach condiment basket to front panel.



7 Items to Assemble
1 Side Bottom Assembly
4 Screws

- A Attach side bottom assembly to grill bottom and inside rails.
- B Place sure ris on each side of bottom casting. Be careful not to dislodge burner tubes into notches on casting seat.
- C Attach four screws inside grill bottom and into casting seat.

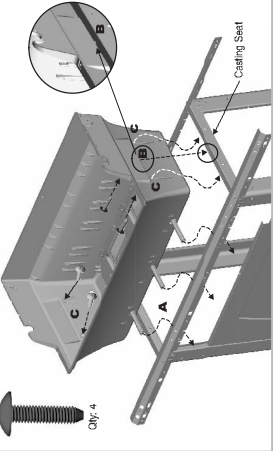

8 Items to Assemble
2 U-Nuts
Qty: 2
Qty: 2
Qty: 2

- A Place u-nut as shown into indent on left and right side of grill bottom.

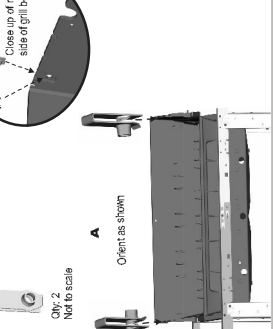

9 Items to Assemble
1 Electrode/Wiring Nut or Nut

- A Inside bottom casting, insert electrode and finger tighten with wing nut or nut.

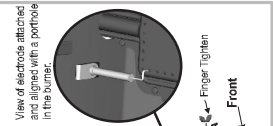

10 Items to Assemble
1 Gas Valve Assembly
2 Screws

- A Loosen long wire and place behind front panel. Do not connect at this time.
- B Attach correct panel cable to back casting. Attach ignitor wire to electrode.
- C Position regulator into opening in front panel.
- D Insert regulator into burner tubes (see burner valve view). Rotate panel up and rest flange over rail.
- E Attach control panel to legs with a screw in top hole on each side.

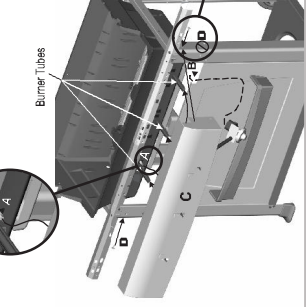

11 Items to Assemble
1 Shelf
5 Screws
1 Fascia

- A Shelf slides into rails. Secure with 4 screws.
- B Attach fascia to back of shelf. Be sure fascia is flush with leg through control panel and leg.
- C Fasten fascia with 1 screw into second hole.

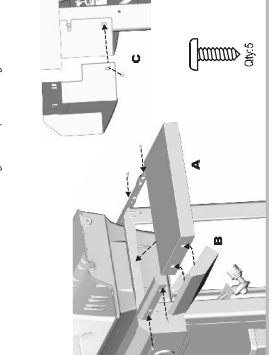

12 Items to Assemble
1 Sideburner Body Assembly
1 Sideburner Grate
1 Sideburner Burner
1 Metal Wing Nut
4 Screws

- A Slide sideburner body assembly onto rails.
- B Attach with 4 screws.
- C Insert sideburner burner into sideburner body. Be sure burner is flush with wing nut before attaching.
- D Place sideburner grate and sideburner body onto sideburner body.

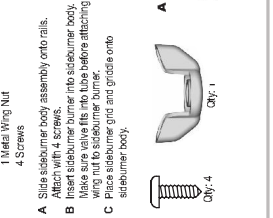

13 Items to Assemble
1 Gas Valve Assembly
2 Screws, 5/16"

- A Place sideburner kit onto sideburner body. Attach gas valve to sideburner body.
- B Attach gas valve from electronic ignition module to electrode beneath sideburner.

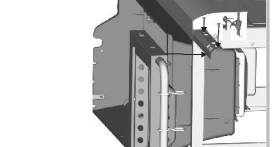

13 Items to Assemble
1 Gas Valve Assembly
2 Screws, 5/16"

- A Place sideburner kit onto sideburner body. Attach gas valve to sideburner body.
- B Attach gas valve from electronic ignition module to electrode beneath sideburner.

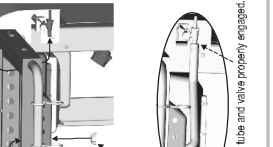

13 Items to Assemble
1 Gas Valve Assembly
2 Screws, 5/16"

- A Place sideburner kit onto sideburner body. Attach gas valve to sideburner body.
- B Attach gas valve from electronic ignition module to electrode beneath sideburner.

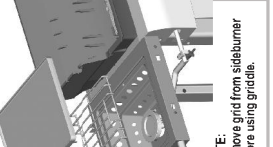

NOTE:
Remove grid from sideburner before using griddle.