

This Owner's Manual is provided and hosted by [Appliance Factory Parts](http://www.appliancefactoryparts.com).



Coleman 9944-785 Owner's Manual

[Shop genuine replacement parts for Coleman 9944-785](#)



[Find Your Coleman Grill Parts - Select From 255 Models](#)

----- Manual continues below -----



Propane Stove 9944 Series

INSTRUCTIONS FOR USE

U.S. Patent No. D498,388
© 2006 The Coleman Company, Inc.
www.coleman.com



For Outdoor Use Only

IMPORTANT

CONSUMER/USER: This instruction manual contains important information necessary for the proper assembly and safe use of the appliance. Read and follow all warnings and instructions before assembling and using the appliance. Follow all warnings and instructions when using the appliance. Keep this manual for future reference.

If you have questions about assembly, operation, servicing or repair of these grills, please call Coleman at 1-800-835-3278 or TDD: 316-832-8707. In Canada call 1-800-387-6161.



ANSI Z21.89-CSA 1.18 (2004)
Outdoor Cooking Specialty Gas Appliance

Contents

General Safety Information
To Set up
Fill Pan with Water
Burner and Orifice
Leak Check
Setup with Hose and Refillable Cylinder
Operation
To Light
Cooking Tips
To Turn Off
Tear Down/Clean
Storage
Maintenance
Troubleshooting
Service
Things You Should Know
Replacement Parts
Accessories
Warranty

General Safety Information

DANGER

If you smell gas:

1. Shut off gas to the appliance.
2. Extinguish any open flame.
3. Open lid.
4. If odor continues, keep away from the appliance and immediately call your gas supplier or your fire department.

Failure to follow these instructions could result in fire or explosion which could cause property damage, personal injury or death.

DANGER

1. Never operate this appliance unattended.
2. Never operate this appliance within 10 feet (3.05 m) of any other gas cylinder.
3. Never operate this appliance within 25 feet (7.5 m) of any flammable liquid.
4. Do not fill cooking vessel beyond maximum fill line.
5. Heated liquids remain at scalding temperatures long after the cooking process. Never touch cooking appliance until liquids have cooled to 115°F (45°C) or less.
6. If a fire should occur, keep away from the appliance and immediately call your fire department. Do not attempt to extinguish an oil or grease fire with water.

Failure to follow these instructions could result in fire, explosion or burn hazard, which could cause property damage, personal injury or death.

Only persons who can understand and follow the instructions should use or service this outdoor stove.

If you need assistance or outdoor stove information such as an instruction manual or labels, contact The Coleman Company, Inc.

DANGER





CARBON MONOXIDE HAZARD

- This appliance can produce carbon monoxide which has no odor.
- Using it in an enclosed space can kill you.
- Never use this appliance in an enclosed space such as a camper, tent, car or home.

CAUTION

- The use of alcohol, prescription or non-prescription drugs may impair your ability to properly assemble or safely operate the appliance.
- When cooking with oil/grease, fire extinguishing materials shall be readily accessible. In the event of an oil/grease fire, do not attempt to extinguish with water. Use Type BC dry chemical fire extinguisher or smother fire with dirt, sand or baking soda. Immediately call the fire department.
- In the event of rain or other forms of precipitation while cooking with oil/grease, cover the cooking vessel immediately and turn off the appliance burners and gas supply. Do not attempt to move the appliance or cooking vessel.
- When cooking, the appliance must be on a level, stable surface in an area clear of combustible material. An asphalt surface (blacktop) may not be acceptable for this purpose.
- Do not leave the appliance unattended. Keep children and pets away from the appliance at all times.
- Do not place empty cooking vessel on the appliance while in operation. Use caution when placing anything in cooking vessel while the appliance is in operation.
- Do not move the appliance when in use.
- This appliance is not intended for and should never be used as a heater.

This manual contains important information about the assembly, operation and maintenance of this outdoor propane appliance. General safety information is presented on this page and is also located throughout these instructions. Particular attention should be paid to information accompanied by the safety alert symbol “ DANGER”, “ WARNING”, “ CAUTION”.

Keep this manual for future reference and to educate new users of this product. This manual should be read in conjunction with the labeling on the product.

Safety precautions are essential when a mechanical or propane fueled equipment is involved. These precautions are necessary when using, storing, and servicing. Using this equipment with the respect and caution demanded will reduce the possibilities of personal injury or property damage.

The following symbols shown below are used extensively throughout these instructions. Always heed these precautions, as they are essential when using any mechanical or propane fueled equipment.

⚠ DANGER

DANGER indicates an imminently hazardous situation which, if not avoided, will result in death or serious injury.

⚠ WARNING

WARNING indicates a potentially hazardous situation which, if not avoided, could result in death or serious injury.

⚠ CAUTION

CAUTION indicates a potentially hazardous situation which, if not avoided, may result in minor or moderate personal injury, or property damage.

⚠ DANGER



• EXPLOSION - FIRE HAZARD

- Never store propane near high heat, open flames, pilot lights, direct sunlight, other ignition sources or where temperatures exceed 120 degrees F (49°C).
- Propane gas is heavier than air and leaking propane will sink to the lowest level possible. It can ignite by ignition sources including matches, lighters, sparks or open flames of any kind many feet away from the original leak. If you smell gas, leave the area immediately.
- Never install or remove propane tank while outdoor stove is lighted, near flame, pilot lights, other ignition sources or while outdoor stove is hot to touch.
- During operation, this product can be a source of ignition. Never use the stove in spaces that contain or may contain volatile or airborne combustibles, or products such as gasoline, solvents, paint thinner, dust particles or unknown chemicals. Minimum distance from sides and back of unit to walls or railings is 12 inches (30.5 cm). Do not use under overhead unprotected combustible construction.
- Provide adequate clearances around air openings into the combustion chamber.
- DO NOT use gas stove indoors or store any propane cylinder(s) indoors, including in the garage, breezeways, sheds or enclosed areas.
- Do not obstruct the flow of combustion and ventilation air.

⚠ WARNING

We cannot foresee every use which may be made of our products.

Check with your local fire safety authority if you have questions about use.

Other standards govern the use of fuel gases and heat producing products for specific uses. Your local authorities can advise you about these.

- Never refill disposable cylinders.
- Use the preset regulator that came with the stove. Do not attempt to adjust.
- The installation must conform with local codes or, in absence of local codes, with the *National Fuel Gas Code, ANSI Z223.1/NFPA 54, Storage and Handling of Liquefied Petroleum Gases, ANSI/NFPA 58 or CSA B149.1, Natural Gas and Propane Installation Code.*
- This appliance is not intended to be installed in or on recreational vehicles and/or boats.
- This appliance is not intended for commercial use.

⚠ DANGER



• CARBON MONOXIDE HAZARD

- This stove is a combustion appliance. All combustion appliances produce carbon monoxide (CO) during the combustion process. This product is designed to produce extremely minute, non-hazardous amounts of CO if used and maintained in accordance with all warnings and instructions. Do not block air flow into or out of the stove.
- Carbon Monoxide (CO) poisoning produces flu-like symptoms, watery eyes, headaches, dizziness, fatigue and possibly death. You can't see it and you can't smell it. It's an invisible killer. If these symptoms are present during operation of this product **get fresh air immediately!**
- **For outdoor use only. If stored indoors, detach and leave cylinder outdoors.**
- **Never use inside house, camper, tent, vehicle or other unventilated or enclosed areas. This stove consumes air (oxygen). Do not use in unventilated or enclosed areas to avoid endangering your life.**

CALIFORNIA PROPOSITION 65:

WARNING: This fuel, and byproducts of combustion of this fuel, contain chemicals known to the state of California to cause cancer, birth defects, or other reproductive harm.

⚠ WARNING

- This product is fueled by propane gas. Propane gas is invisible, odorless, and flammable. An odorant is normally added to help detect leaks and can be described as a "rotten egg" smell. The odorant can fade over time so leaking gas is not always detectable by smell alone.
- Use only propane gas set up for vapor withdrawal.
- Propane gas should be stored or used in compliance with local ordinances and codes or with ANSI/NFPA 58. Turn off propane and disconnect cylinder when not in use.
- Cylinders must be stored out of reach of children.

⚠ WARNING



• BURN HAZARD

- Never leave stove unattended when hot or in use.
- Keep out of reach of children.

⚠ CAUTION

• SERVICE SAFETY

- Keep all connections and fittings clean. Inspect propane cylinder and stove propane connections for damage before attaching.
- During set up, check all connections and fittings for leaks using soapy water. Never use a flame. Bubbles indicate a leak. Check that the connection is not cross-threaded and that it is tight. Perform another leak check. If there is still a leak, remove the cylinder and contact Coleman for service or repairs.
- Use as a cooking appliance only. Never alter in any way or use with any device or part not expressly approved by Coleman.
- Clean stove frequently to avoid grease accumulation and possible grease fires.

Technical Characteristics

Input: 16,000 BTU/H

Category: Pressure regulated propane

Fuel: 16.4 oz. disposable propane cylinders

Regulator: 9944

To Set Up

Step 1

- Remove stove, legs and regulator from packaging.
- Regulator is packed in the end of the Styrofoam near front of stove.
- Inspect all packing and remove all parts.
- Your unit includes:
 - (2) Side tables
 - (1) Stove
 - (1) Lid
 - (1) Waterpan
 - (1) Regulator
 - (1) Grill
 - (4) Legs



■ See replacement parts list for identification.

Step 2

- Use a ground cloth to protect the finish.
- Place stove on back and remove side tables.



- Remove legs from mounting brackets on bottom of stove.



- Thread legs into receivers on bottom of stove handles.



- Stand stove up and adjust leg levelers if necessary.



Step 3

- Place side table wire fingers in holes on top of stove handles and push down on table until it stops.



Step 4

- Open Lid.
- Remove packing from cooking surfaces, merchandising material from inside lid, and any other combustible materials from inside the stove.

Fill Pan with Water

CAUTION

- Do not use the stove without the water pan in place.
- Coleman recommends water in the water pan when in use. This will help prevent a grease flare-up.

- Make sure pins in WATER PAN match holes in COOKTOP.



- Cleanup will be improved if you fill WATER PAN to mark indicated (MAX).



To Set Up cont.

- Place the grill onto the stove.



Burner and Orifice

- Proper location of the burner with respect to the orifice is important. To verify the proper installation of the burner tube, remove the water pan and look downward through the opening. The burner tube must be located over the brass orifice fitting.

- Check and clean the burner/venturi tubes for insects and insect nests. A clogged tube can lead to a fire beneath the appliance.

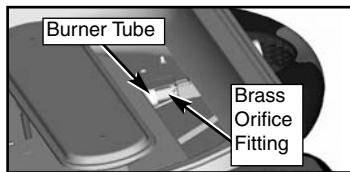

Leak Check

⚠ WARNING

- Perform leak test outdoors.
- Extinguish all open flames.
- NEVER leak test when smoking.
- Do not use the outdoor stove until connection has been leak tested and does not leak.

NOTE: Use Coleman® 16.4 oz disposable propane cylinders. The LP gas cylinder(s) used with stoves must be constructed and marked in accordance with the specifications for LP-gas cylinders of the U.S. Department of Transportation or *Transport Canada, CAN/CSA B339, Cylinders, Spheres and Tubes for the Transportation of Dangerous Goods.*

Leak Check cont.

Step 1

- Make sure burner valve is off.

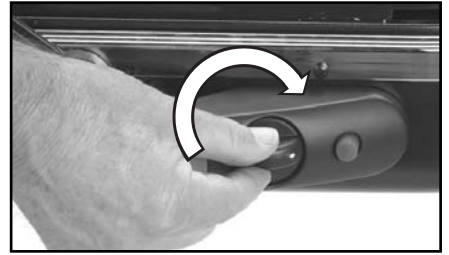

Step 2

- Remove plastic cap from top of propane cylinder. Save cap for use in storing. Screw propane cylinder into REGULATOR. Be careful not to cross-thread. **HAND TIGHTEN** only.



Step 3

- Check the connection between the cylinder and the regulator with soapy water. Bubbles indicate a leak. Check that the connection is not cross-threaded and that it is tight. Perform another leak check. If there is still a leak, remove the cylinder and contact Coleman for service or repairs.

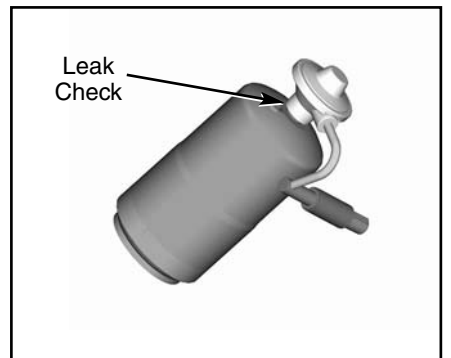

- The regulator uses a threaded fitting to attach to the stove. It is necessary to hold the stove to make sure the fitting is seated. Align the regulator to the fuel tube on the rear of the stove and push on. Screw on the outer threaded sleeve in a clockwise direction until tight.



Step 4

- Never operate stove with propane cylinder in an inverted position.



⚠ WARNING

- Read and follow all instructions and warnings provided with your appliance.
- Do not store LP gas cylinders under or near this appliance.
- Never fill the cylinder beyond 80% full.
- Failure to follow the above instructions exactly may result in fire causing death or serious injury.

- When used with a stove, the maximum pot size is 12 inches diameter and the minimum pot size is 7 1/2 inches diameter.
- When using extension hose always point the cylinder valve toward the fuel inlet of the appliance.
- Maintain proper clearances between cylinder and appliance. The stove must be used on stand or legs with 20-24 inch clearance between cylinder and inlet of appliance.
- Clean and inspect the hose before each use. If there is evidence of abrasion, wear, cuts or leaks, the hose must be replaced prior to use. The replacement hose must be that specified by The Coleman Company, Inc.
- Never alter in any way or use with any device or part not expressly approved by Coleman.

INSTRUCTIONS FOR USE:

- High Pressure Hose Extension 9941-130 is only for use with Coleman propane appliance models 9941, 9944, and 9948.
- Do not use extension hose when operating appliance on table top. Use disposable 16.4 oz. propane cylinders when operating on table top.
- The LP-gas supply cylinder to be used must be constructed and marked in accordance with the specifications for LP-gas cylinders of the U.S. Department of Transportation (DOT) or the National Standard of Canada, *CAN/CSA B339, Cylinders, Spheres and Tubes for the Transportation of Dangerous Goods*.
- If a refillable cylinder is used, it must have a collar to protect the cylinder valve.

ASSEMBLING HIGH PRESSURE HOSE:

- Make sure burner valves are off. (Fig. 1)
- Attach hose to regulator and regulator to stove. (Fig. 2)
- Attach hose to cylinder. (Fig. 3)
- Open cylinder valve.
- Perform leak check on Hose to Regulator, and Hose to Cylinder connections with soapy water. Bubbles indicate a leak. Check that the connection is not cross-threaded and that it is tight. Perform another leak check. If there is still a leak, remove the cylinder and contact Coleman for service or repairs. (Fig. 4 and 5)

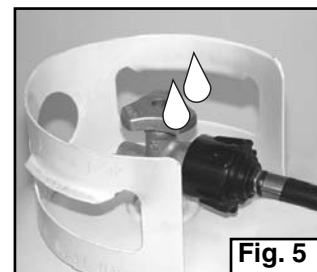
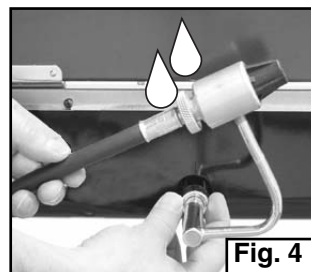
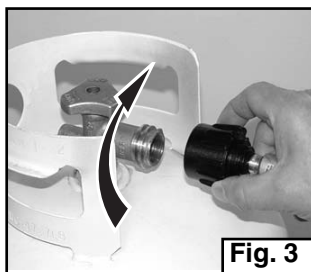
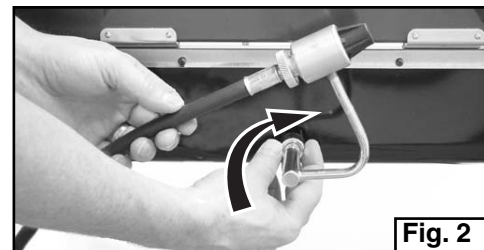
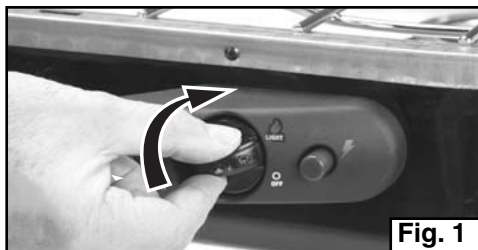

DISMANTLING HIGH PRESSURE HOSE:

- Before dismantling high pressure hose, be sure gas pressure in hose is eliminated.
- Ignite stove and turn off gas valve on cylinder.
- Allow flame to self-extinguish.
- When flame is out, close valves on appliance.
- Remove hose.

⚠ WARNING

- For use with leg or stand equipped appliances only.
- The gas hose is a tripping hazard. Keep yourself and others away from the gas hose when in use or attached to an appliance.
- Do not tip or move the fuel supply.

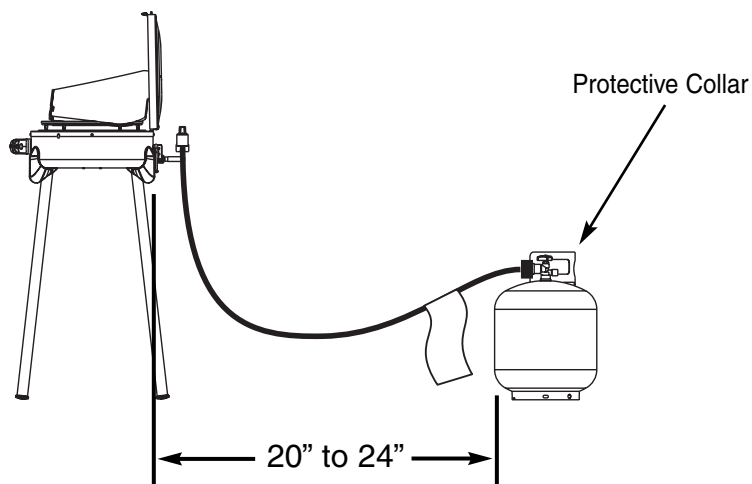

- Turn off fuel at the cylinder and disconnect both ends of the hose when not in use.
- You must follow these instructions exactly or a fire causing death or serious injury may occur.

Operation

DANGER



• CARBON MONOXIDE HAZARD

- For outdoor use only.
- Never use inside house, or other unventilated or enclosed areas. This outdoor stove consumes air (oxygen). Do not use in unventilated or enclosed areas to avoid endangering your life.

DANGER



• EXPLOSION - FIRE HAZARD

- Propane is heavier than air and can accumulate in low places. If you smell gas, leave the area immediately.
- Always attach or detach propane source outdoors; never while stove is lighted, near flame, pilot lights, other ignition sources or while stove is hot to touch.
- This stove is very hot during use and can ignite flammables too close to the burner. Minimum distance from sides and back of unit to walls or railings is 12 inches (30.5 cm). Do not use under overhead unprotected combustible construction. Keep gasoline and other flammable liquids and vapors well away from stove.

- Do not attempt to operate until you have read and understood all General Safety Information in this manual and all assembly is complete and leak checks have been performed.

To Light

WARNING



• BURN HAZARD

- This appliance will be hot during and after use. Use insulated oven mitts or gloves for protection from hot surfaces or splatter from cooking liquids.
- Never leave stove unattended when hot or in use.
- Keep out of reach of children.

- Open the stove lid. Do not attempt to light the stove with lid closed.
- Open BURNER VALVE and push igniter button several times until burner lights. (If the stove is wet, the igniter may not spark until it dries out.)



To Light *cont.*

- The unit may be match lighted if there is no ignition.
- First, remove cooking surface.
- Hold lit match next to BURNER and open BURNER VALVE slowly.



- Adjust flame to desired heat level.



- A good flame should be blue with minimal yellow tip. Some yellow tips on flames are acceptable as long as no carbon or soot deposits appear.

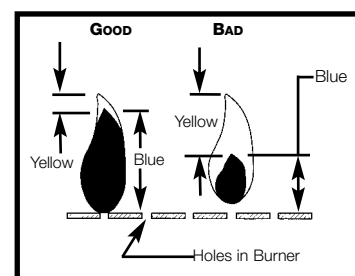

NOTE: If the burner flame is accidentally extinguished, turn off the regulator valve and wait 5 minutes before relighting the appliance.

Cooking Tips

CAUTION

- Do not place a pot or a pan on grill surface. Damage will occur and void the warranty.

- Clean cooking surface with warm water and detergent before first use.
- The grill has a porcelain coating.
- The grill surface is ideal for steaks, hamburgers or chicken.
- Coleman recommends fresh water in the water pan when in use. Fresh water in the water pan will help food taste better and keep it from drying out.
- The lid is removable. Tilt forward and lift.



To Turn Off

- Push the burner valve knob inward and close burner valve firmly.



Tear Down/Clean

- Be sure stove is cool.
- Always detach propane cylinder outdoors away from ignition sources.
- Unscrew the threaded outer sleeve that connects the regulator to the stove by turning it counterclockwise then remove regulator from the stove fuel line.
- Detach propane cylinder from regulator and replace the plastic protective cap onto cylinder threads.



- Be sure surfaces are cool.
- Remove the grill. Clean the grill with warm water & detergent.



- Remove the water pan and discard the water and grease.
- Clean the water pan with warm water and mild household cleaner. Do not use abrasives.
- Wipe the stove clean with soft cloth and mild household cleaner. Do not use abrasives.



Tear Down/Clean *cont.*

To Remove Side Table(s)

- Remove side table(s).



To Remove Legs from Stove

- Place stove on back and unscrew legs from receivers in stove handles.
- Thread foot pad into leg.



- Snap legs in mounting brackets on bottom of stove.



- Align arrows on side tables with legs on stove and snap tables to bottom for storage.



- When transporting stove, ensure that lid is locked.



Storage

DANGER



• EXPLOSION - FIRE HAZARD

- Never store propane near high heat, open flames, pilot lights, direct sunlight, other ignition sources or where temperatures exceed 120 degrees F (49°C).
- The cylinder must be disconnected when the stove is in storage.
- Do not store a spare LP-gas cylinder under or near this appliance. Failure to follow the above instructions exactly may result in fire causing death or serious injury.

- Store propane tank in safe manner. Refer to Chapter 5 of *Standard for Storage and Handling of Liquefied Gases*, ANSI/NFPA 58. Follow all local codes. Always store propane tanks outdoors.
- Store stove in a dry, clean and safe place.
- Place the cleaned water pan, grill, griddle and REGULATOR into the stove for storage.
- For long-time storage, clean and dry all stove parts before storing. This will keep the unit clean and ready for the next season.

Maintenance

WARNING



• BURN HAZARD

- Do not touch or attempt any maintenance on stove for at least one hour after use.
- Make sure all controls are off and propane tank has been removed before doing maintenance.

To enjoy years of outstanding performance from your stove, perform the following maintenance activities on a regular basis:

- Keep exterior surfaces clean.
- Use warm soapy water for cleaning. Never use flammable or abrasive cleaning agents.

- Airflow must be unobstructed. Keep controls, burner and circulating air passages clean. Signs of possible blockage include:
 - Gas odor
 - Stove makes popping noises
 - Smoky flame.
- Spiders and insects can nest in burner orifices. This condition can damage the stove and render it unsafe for use. Clean burner holes by using a heavy-duty pipe cleaner. Compressed air may help clear away small particles.
- Carbon deposits may create a fire hazard. Clean burner with warm soapy water if any carbon deposits develop.
- If the stove has been left uncovered and is wet from rain, snow, yard sprinklers, etc., allow to dry (at least 30 minutes prior to use).
- NOTE: In a salt-air environment (such as near an ocean), corrosion occurs more quickly than normal. Frequently check for corroded areas and repair them promptly.

Troubleshooting

Problem	Possible Cause	Solution
Burner won't light	Gas pressure is low.	Cylinder is empty. Replace cylinder.
	Air in gas line.	Burner may take up to one minute to light after a propane bottle has been connected.
	Igniter is wet.	Light the stove with a match.
Burner won't stay lit	Dust and/or dirt built up around burner	Clean dirt and/or dust from around burner.
Burner flame is low	Gas pressure is low	Replace cylinder.
	Outdoor temperature is less than 40° F and tank is less than 1/4 full.	Use a full cylinder.
	Fuel flow is restricted.	Check burner and orifices for blockage. Adjust control knob to full ON position.
Improper Flame (Flame should be blue with hint of yellow on tips)	Fuel flow is restricted.	Check burner, orifices and venturi for blockage (bugs, dirt, cobwebs).

Service

- Repair to gas passages and associated components should be done only by Coleman or an authorized service person.
- Owner repair and service should be limited and performed only to the following:
 - Cleaning
 - Cylinder replacement
- For Authorized Repair & Service, call 1-800-835-3278.

Things you should know

1. It is unsafe and illegal in some places to store or use propane cylinders of greater than 1.14 kg (2.5 lbs) water capacity (approximately 1 lb. propane) in occupied enclosures.
2. If using refillable propane cylinder, use only Coleman® parts and accessories.
3. The usual storage areas for camping and picnic equipment are the basement, attic, or garage. To avoid the accumulation of dust, cobwebs, etc., that is common in these areas, place your stove in optional carry case (sold separately) or a plastic bag and seal it with a rubber band.
4. For repair service call one of the numbers listed on the cover of this manual for location of your nearest Coleman Service Center. If product must be mailed to Service Center, attach to product your name, address and a description of problem and mail to Service center with shipping and **insurance** prepaid. If necessary to write the Service Center or factory, refer to your stove by model number. **Do not send propane cylinder.**
5. If not completely satisfied with the performance of this product, please call one of the numbers listed on the cover of this manual.

Replacement Parts

Parts List

No. Part No. Description

1	9944-5081	Lid Assembly
2	9944-3151	Grill
3	9944-3301	Water Pan
4	9944-5631	Side Table Assembly
5	9944-1891	Leg Assembly
6	9944-1881	Foot Pad
7	9942-1491	Control Knob
8	9942A5251	Regulator Assembly

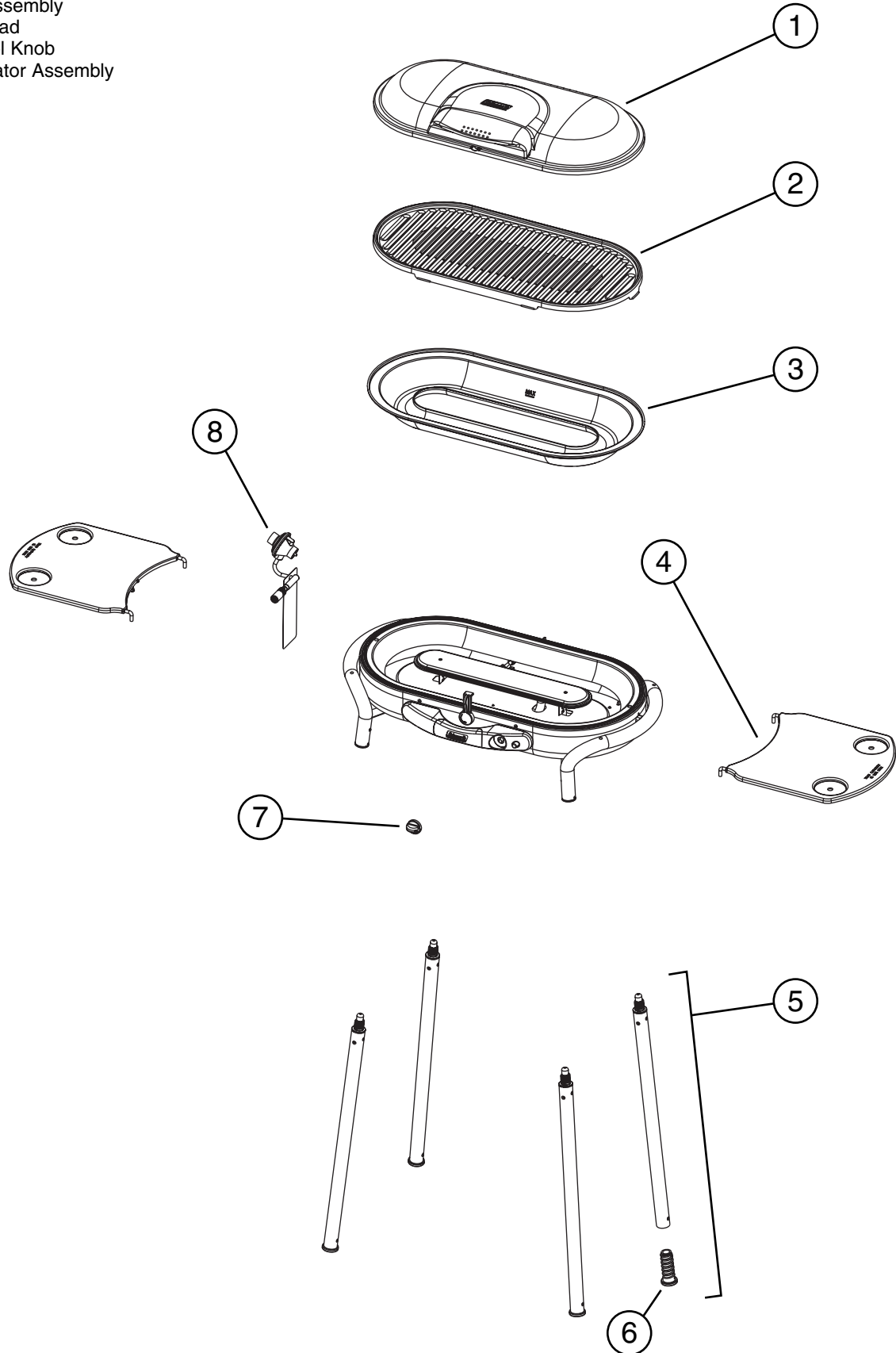

Accessories

The following accessories are available:

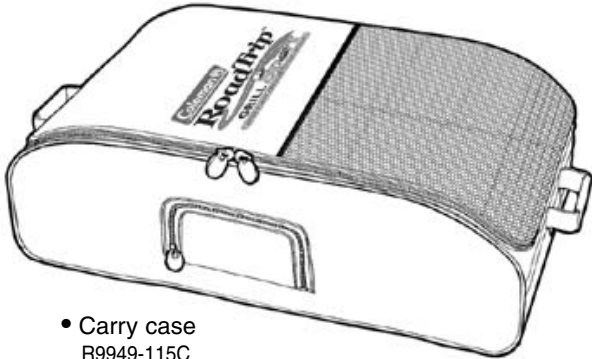

- Carry case
R9949-115C



- 5 ft. High Pressure Hose & Adapter (connects appliance to refillable propane cylinder)
9941-1301

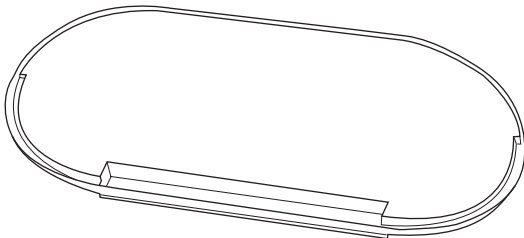

- Full Griddle
R9941A325C

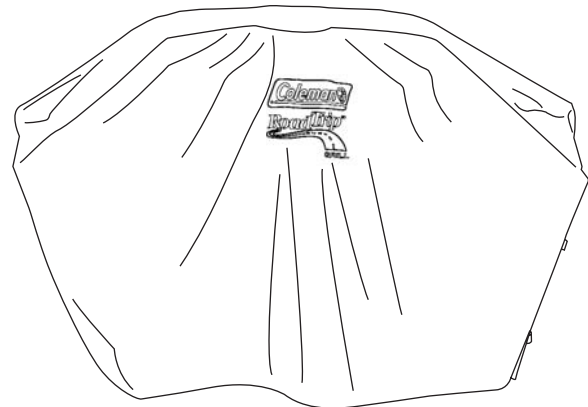

- Grill Cover
R9941-150C

Visit us at www.coleman.com
or
Call us at 1-800-835-3278

Limited Five Year Warranty

The Coleman Company, Inc. ("Coleman") warrants that for a period of five years from the date of original retail purchase, this product will be free from defects in material and workmanship. Coleman, at its option, will repair or replace this product or any component of the product found to be defective during the warranty period. Replacement will be made with a new or remanufactured product or component. If the product is no longer available, replacement may be made with a similar product of equal or greater value. This is your exclusive warranty.

This warranty is valid for the original retail purchaser from the date of initial retail purchase and is not transferable. Keep the original sales receipt. Proof of purchase is required to obtain warranty performance. Coleman dealers, service centers, or retail stores selling Coleman® products do not have the right to alter, modify or in any way change the terms and conditions of this warranty.

What This Warranty Does Not Cover

This warranty does not cover normal wear of parts, parts that are not genuine Coleman® parts, or damage resulting from any of the following: negligent use or misuse of the product; use on improper voltage or current; commercial use of the product; use contrary to the operating instructions; disassembly, repair or alteration by anyone other than Coleman or an authorized service center. Further, the warranty does not cover Acts of God, such as fire, flood, hurricanes and tornadoes. Warranty void if damage to product results from the use of a part other than a genuine Coleman® part.

COLEMAN SHALL NOT BE LIABLE FOR DEFECTS THAT ARE CAUSED BY THE USE OF UNAUTHORIZED PARTS OR SERVICE. COLEMAN SHALL NOT BE LIABLE FOR ANY INCIDENTAL OR CONSEQUENTIAL DAMAGES CAUSED BY THE BREACH OF ANY EXPRESS OR IMPLIED WARRANTY OR CONDITIONS. EXCEPT TO THE EXTENT PROHIBITED BY APPLICABLE LAW, ANY IMPLIED WARRANTY OF MERCHANTABILITY OR FITNESS FOR A PARTICULAR PURPOSE IS LIMITED IN DURATION TO THE DURATION OF THE ABOVE WARRANTY OR CONDITIONS. SOME STATES, PROVINCES, OR JURISDICTIONS DO NOT ALLOW THE EXCLUSION OR LIMITATION OF INCIDENTAL OR CONSEQUENTIAL DAMAGES OR LIMITATIONS ON HOW LONG AN IMPLIED WARRANTY LASTS, SO THE ABOVE LIMITATIONS OR

EXCLUSION MAY NOT APPLY TO YOU. THIS WARRANTY GIVES YOU SPECIFIC LEGAL RIGHTS, AND YOU MAY ALSO HAVE OTHER RIGHTS THAT VARY FROM STATE TO STATE OR PROVINCE TO PROVINCE.

How to Obtain Warranty Service

Take the product to an authorized Coleman service center. You can find the nearest authorized Coleman service center by visiting www.coleman.com or calling 1-800-835-3278 or TDD 316-832-8707 in the United States or 1 800 387-6161 in Canada. If a service center is not conveniently located, attach to the product a tag that includes your name, address, daytime telephone number and description of the problem. Include a copy of the original sales receipt. Carefully package the product and send either by UPS or Parcel Post **insured** with shipping and **insurance** prepaid to:

For products purchased in the United States:

The Coleman Company, Inc.
3600 North Hydraulic
Wichita, KS 67219

For products purchased in Canada:

Sunbeam Corporation (Canada) Limited
DBA Jarden Consumer Solutions
5975 Falbourne Street
Mississauga, Ontario
Canada L5R 3V8

The costs of transporting the product to Coleman or an authorized service center for warranty service is the responsibility of the purchaser.

Do not mail products with fuel in tanks, or with disposable propane cylinders. Remove glass globes from lanterns and wrap separately.

DO NOT RETURN THIS PRODUCT TO THE PLACE OF PURCHASE.

If you have any questions regarding this warranty please call 1-800-835-3278 or TDD 316-832-8707 in the United States or 1 800 387-6161 in Canada.

The Coleman Company, Inc.
3600 North Hydraulic
Wichita, KS 67219 U.S.A.
1-800-835-3278
TDD: 316-832-8707
www.coleman.com

