

### 1

**Items to Assemble**  
 1 Long Leg Assembly  
 1 Short Leg Assembly  
 5 Screws

- A Place bottom shell on table or grill container.
- B Insert legs on long leg assembly on each side.
- C Attach leg assembly with one screw on each side.
- D Repeat step B and C for short leg assembly.

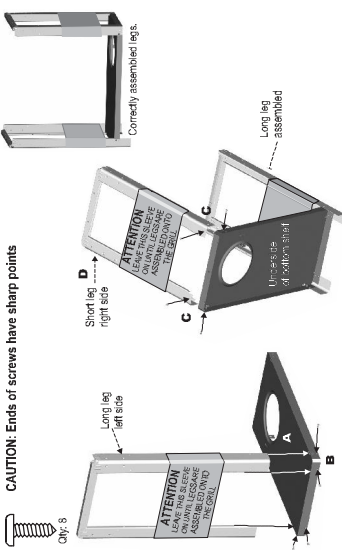

### 2

**Items to Assemble**  
 2 Leg Extenders  
 1 U-Nut  
 1 Cylinder Thumbscrew  
 2 Wheels  
 2 Axle Rods  
 2 Flange Hex Screws  
 1 Flange Hex Nut  
 2 Flat Washers  
 1 Hitch Pin

- A Match leg extenders. Check to make sure leg is seated all the way into the leg extender.
- B Attach U-nut to tab. See enlargement of U-nut for correct position.
- C Thread cylinder thumbscrew into hole and U-nut. Screw flanged hex nut onto end of cylinder thumbscrew.
- D Attach washer head screw to axle rod. Slide washer on axle rod. Insert axle rod/wheel into large hole in bottom shell. Attach other wheel and washer head screw. **NEAR. HAND HOLD AXLE ROD TO TIGHTEN WASHER HEAD SCREW.**

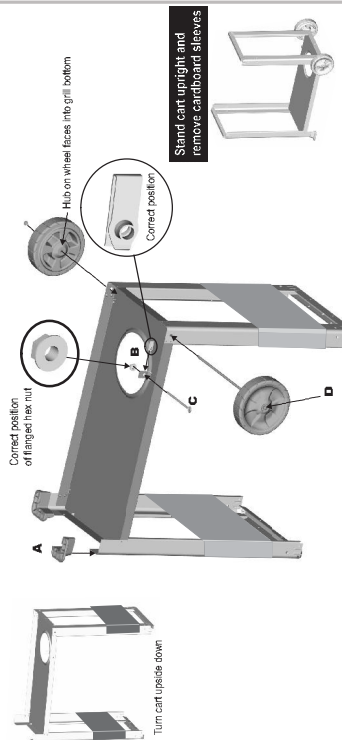

### 3

**Items to Assemble**  
 4 Balls (all identical)  
 10 Screws

- A Overlap balls and hook tabs into slots. Pull rails to latch.
- B Attach one screw in center of each rail.
- C Attach rail and legs with two screws in each corner.

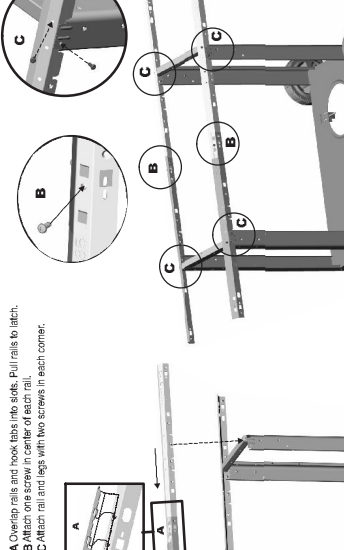

### 4

**Items to Assemble**  
 1 Front Panel  
 2 Push Pins

- A Place tabs on front panel inside leg tabs.
- B Insert push pins into front panel and legs.

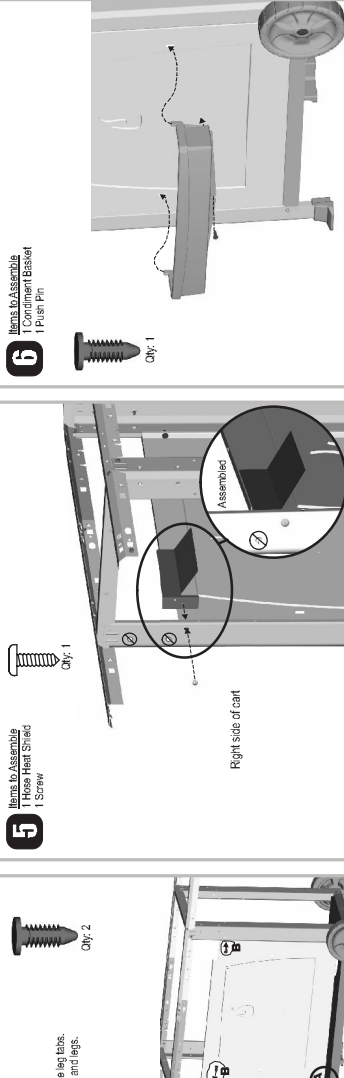

### 5

**Items to Assemble**  
 1 Hose Heat Stroke  
 1 Screw

- A Place tabs on front panel inside leg tabs.
- B Insert push pins into front panel and legs.

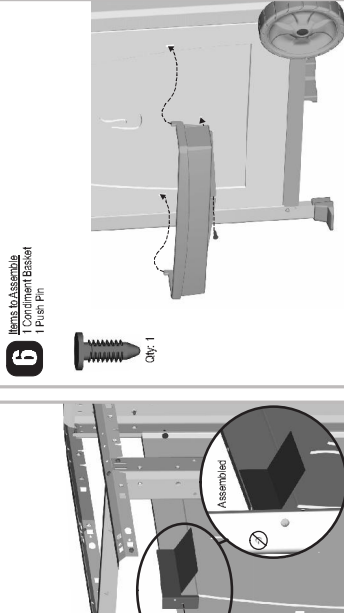

### 6

**Items to Assemble**  
 1 Condition Basket  
 1 Push Pin

- A Place tabs on front panel inside leg tabs.
- B Insert push pins into front panel and legs.

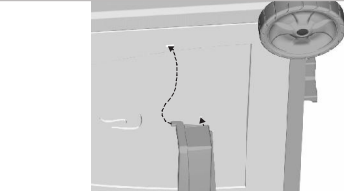

### Parts List - Model 461460806

Part #	Qty.	Description	Part #	Qty.	Description
AA	1	Stiebumer Burner	7000337	1	Stiebumer Burner
BB	1	"S" Hooks Set	7000346	1	"S" Hooks Set
CC	1	Top Casting	7001304	1	Top Casting
DD	1	Bottom Casting	7001235	1	Bottom Casting
EE	1	Burners	7000083	1	Burners
FF	1	Carry-Over Tube	7000279	1	Carry-Over Tube
GG	1	Handle	7000191	1	Handle
HH	2	Condition Basket	7000372	2	Condition Basket
II	2	Wheels	7000262	2	Wheels
JJ	1	Axle Rod	7001148	1	Axle Rod
KK	3	Vaporizer Tents	7000381	3	Vaporizer Tents
LL	1	Grease Tray Assembly	7000043	1	Grease Tray Assembly
MM	1	Grease Pan Assembly	7000046	1	Grease Pan Assembly
NN	1	Fascia, Right	7000594	1	Fascia, Right
OO	2	Fascia, Left	7001305	2	Fascia, Left
PP	2	Leg Extenders	7000230	2	Leg Extenders
QQ	4	Control Knobs	7000237	4	Control Knobs
RR	4	Bezeis	7000312	4	Bezeis
SS	1	Electrode	7000378	1	Electrode
TT	1	Ignition Button	7000161	1	Ignition Button
UU	1	Stiebumer Lid Handle	7000169	1	Stiebumer Lid Handle
VV	1	24" Ignitor Wire	7000864	1	24" Ignitor Wire
WW	1	Stiebumer Body	7001240	1	Stiebumer Body
XX	1	Stiebumer Lid Assy	7001241	1	Stiebumer Lid Assy
YY	2	Washer Head Hex Nuts	7000059	2	Washer Head Hex Nuts
ZZ	1	Stiebumer Frame Insert	7000206	1	Stiebumer Frame Insert
...	1	Hardware Bag	7001289	1	Hardware Bag
...	1	Grill Cover	4187257	1	Grill Cover

### Parts List - Model 461460806

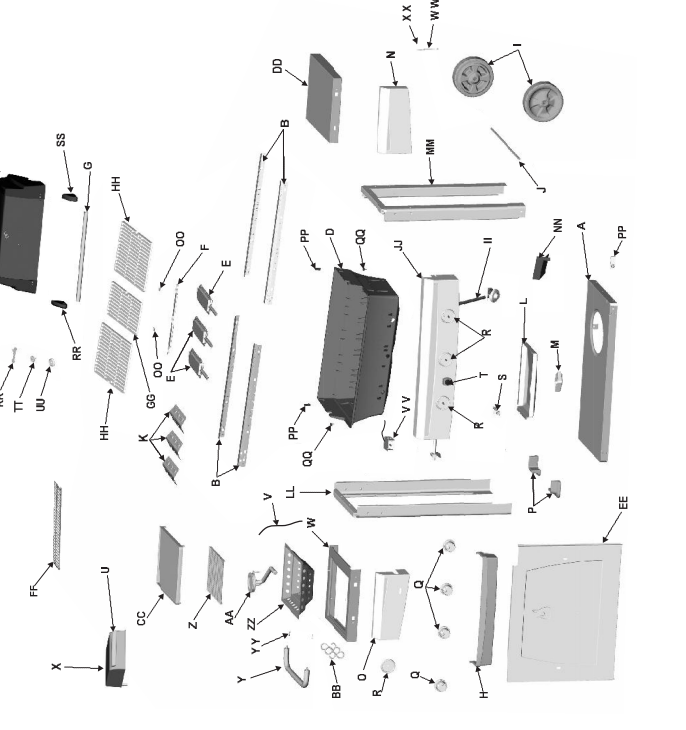

**PERFORMANCE SERIES™**

**THERMOS**

**ASSEMBLY MANUAL**  
 461460806

**THIS GRILL IS FOR OUTDOOR USE ONLY**

**CAUTION:** Read and follow all safety statements, assembly instructions and use and care labels before attempting to assemble and cook.

**WARNING:** Leave these instructions with consumer. **CONSUMER:** Keep this manual for future reference.

**CAUTION:** Failure to follow all manufacturer's instructions could result in serious personal injury and/or property damage.

**CAUTION:** Some parts may contain sharp edges - especially as noted in the manual! Wear protective gloves if necessary.

If you have any questions or need assistance during assembly, please call: 1-800-247-7548.  
 Visit us on the web at: [www.thermos.com](http://www.thermos.com)

**PRECISION GRILLING TECHNOLOGY**

**You have purchased a fine grill from Target**

**Congratulations,**

**Printed in USA**

7001399 - 461460806 (11-28-05) 1