

This Owner's Manual is provided and hosted by [Appliance Factory Parts](#).



Charbroil 463464506 Owner's Manual

[Shop genuine replacement parts for Charbroil
463464506](#)



[Find Your Charbroil Grill Parts - Select From 3592 Models](#)

----- Manual continues below -----

Coleman



ASSEMBLY INSTRUCTIONS FOR 3000 SERIES

ASSEMBLER/INSTALLER:

LEAVE THESE INSTRUCTIONS WITH THE CONSUMER.

CONSUMER/USER:

READ ALL THESE INSTRUCTIONS AND KEEP THEM IN A
SAFE PLACE FOR FUTURE REFERENCE.

WARNING:

THE EDGES OF SHEET METAL PARTS CAN CAUSE INJURY
IF NOT HANDLED WITH CARE.

USE EXTREME CAUTION!

IMPORTANT!

TO ENSURE PROPER GAS FLOW, BURNER
CONTROL VALVES MUST BE "OFF" BEFORE
OPENING THE GAS CYLINDER VALVE.



LOOK INSIDE FOR:

Easy Assembly Instructions

Warranty Information

Safety, Maintenance
and Cleaning Tips

LOOK ON PAGE 2

Pre-cooking seasoning processes and
proper storage treatment of
Cast Iron Grids.

9-Volt Battery Included

Las Instrucciones de Ensamblaje en español en la pa

**BEFORE YOU BEGIN ASSEMBLING
YOUR NEW QUALITY COLEMAN**

GAS BARBECUE GRILL:

- ⇒ FOR EASE OF ASSEMBLY, leave the grill on the inside bottom foam packing tray until the wheels have been attached. (See representative example at right). Remove the outside foam from the right and left sides of the frame base at this time.
- ⇒ Remove all cartons located on top of the barbecue grill base and set aside.

**START THE COOKING GRIDS
SEASONING PROCESS BEFORE
ASSEMBLING YOUR GRILL!**

CAST IRON GRIDS

- ⇒ Cast Iron grids are on select models only.
- ⇒ Your cast iron grids may have some rusting. This is normal. To remove the rust, scour the rusty areas with steelwool, i.e. SOS pad, until all traces of rust are gone. Wash, dry and season grids.

SEASONING CAST IRON GRIDS

SEASONING IS THE PROCESS OF ALLOWING OIL TO BE ABSORBED INTO THE IRON, CREATING A NON-STICK, RUSTPROOF FINISH. HERE'S HOW TO DO IT:

- ⇒ Preheat Oven to 350°F.
- ⇒ Wash with hot, soapy water and a stiff brush. Rinse and dry completely.
- ⇒ Oil the grids (all surfaces, top and bottom) with MELTED solid vegetable shortening.
- ⇒ Turn upside down on the top rack of a 350°F pre-heated oven.
- ⇒ Put aluminum foil on the bottom rack to catch any excess drippings.
- ⇒ Bake the grids for one hour at 350°F.
- ⇒ Let the grid cool slowly in the oven.
- ⇒ Store, uncovered, in a dry place when cooled.

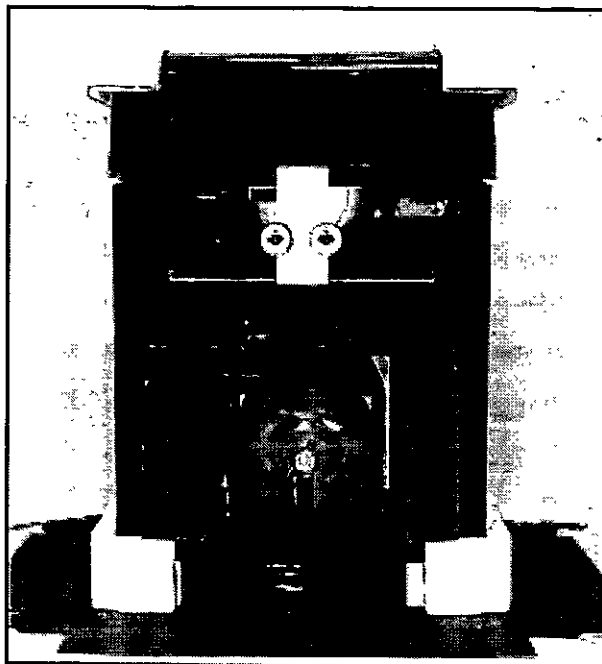

**Engineering Codes
LE113313/LE113333**

CARTON A - MISCELLANEOUS PARTS

Two Wheels	(16)
Two Main Control Knobs	(32)
One Grease Wire	(49)
One Grease Tray	(49a)
Two Grease Drip pans	(48)
One Perforated Tent	(62)
One Meat Probe	(57)
One Meat Probe Receptacle	(57a)
One Handle Assembly	
One Literature Bag	
One 6-lobe Screwdriver	
Hardware bag(s)	
Assorted assembly hardware - One Igniter Kit bag	
Two Axle pins	(3)
Side Burner Models include the following:	
One Side Burner Control Knob	(40)

- ⇒ #20 6-Lobe
- ⇒ #2 Phillips
- ⇒ An adjustab
- ⇒ 9-Volt Batta
- Optional Tools
- ⇒ 7/16" and 5/
- ⇒ 7/16" Nut Dr
- ⇒ Electric or C
- ⇒ #20 6-Lob
- ⇒ #2 Phillip

ONE CAR

CART

(FOR MO

CARTON B

(FOR M

- ONE SIDE BURNER
- ONE RIGHT SIDE T
- ONE LEFT SIDE BU
- One bag Assort

ONE CART

(FOR M

ONE C

Combustion
this product
State of C
defects.



- ⇒ Assemble the DOOR HANDLES (21) to the DOORS (20). See detail 1-A.
- ⇒ Attach the DOOR MAGNETS (19a) to the Door Stop Bracket. See detail 1-B.

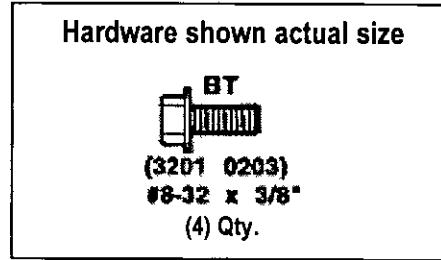
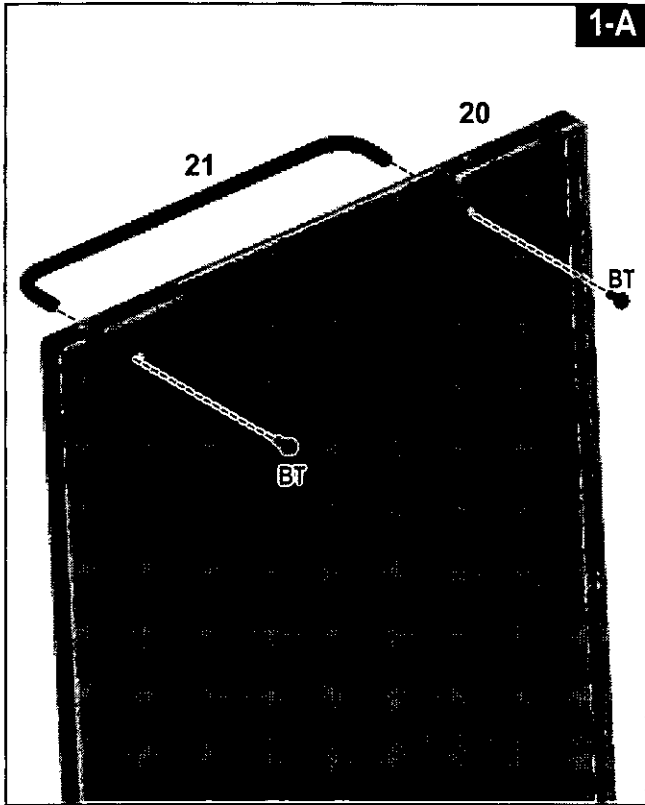

1-B Snap two
Door Stop

1-A Attach a DOOR HANDLE (21) to one DOOR (20) with two screws (BT). Repeat the assembly for the other Door and Door Handle.

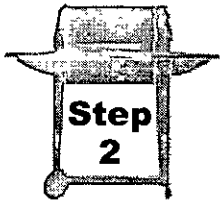

- ⇒ Attach the DOOR STOP (19b) on the grill base. See detail 2-A.
- ⇒ Place the right DOOR (20) on the grill frame. See detail 2-A.
- ⇒ Install the HINGE PIN (20a) in the Door. See detail 2-B.
- ⇒ Repeat 2-A and 2-B for the left DOOR assembly.

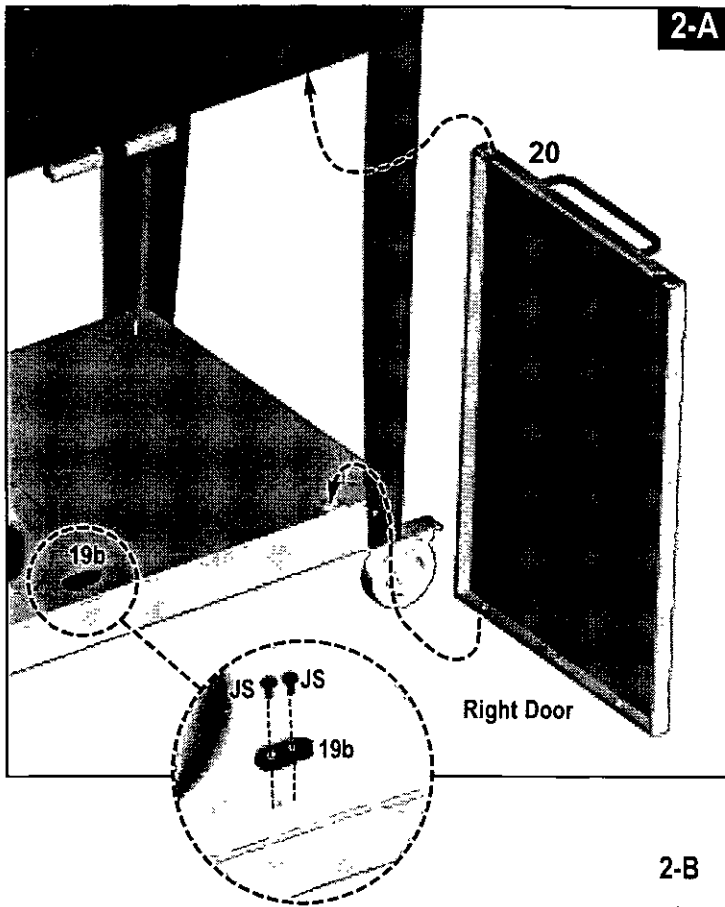

2-A Attach the DOOR STOP (19b) to the base with two screws (JS). Align holes in the DOOR (20) with holes in the Control Panel and base. Hold in place until Hinge pin is put in place.

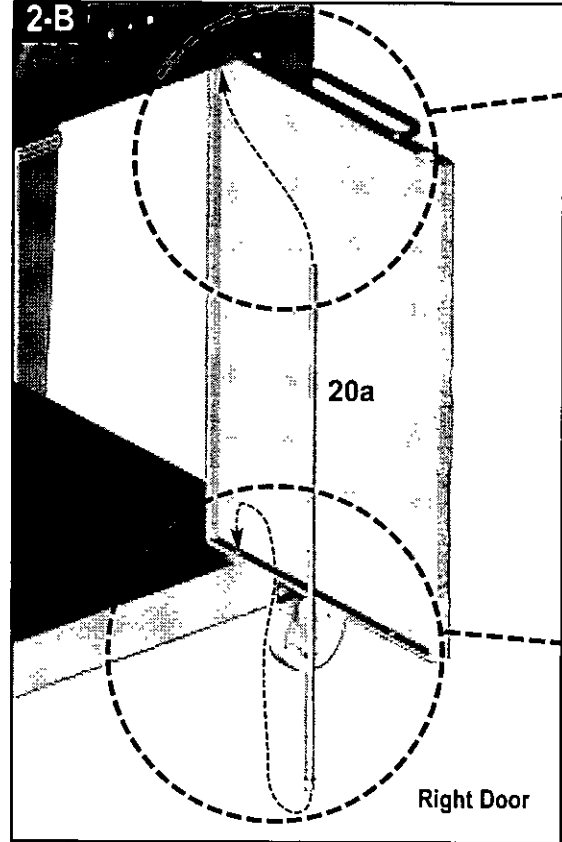

- 2-B** Insert the HINGE PIN (20a) into the Door.
- ⇒ Begin with inserting the Hinge Pin into the top holes of the Door and Control Panel.
 - ⇒ Align the Hinge Pin to the bottom holes in the Door and base. Lower the Hinge pin until Hinge stop rests on the hole in the Door bottom.
 - ⇒ Repeat Assemblies 2-A through 2-B for the Left Door installation.

HELPFUL HINTS FOR DOOR ASSEMBLY

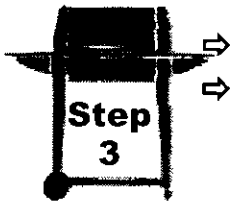

- ⇒ Remove outside foam from the **LEFT SIDE** and **RIGHT SIDE** of the **BASE**.
- ⇒ Check the alignment of the doors with the control panel. See details 3-A and 3-B.

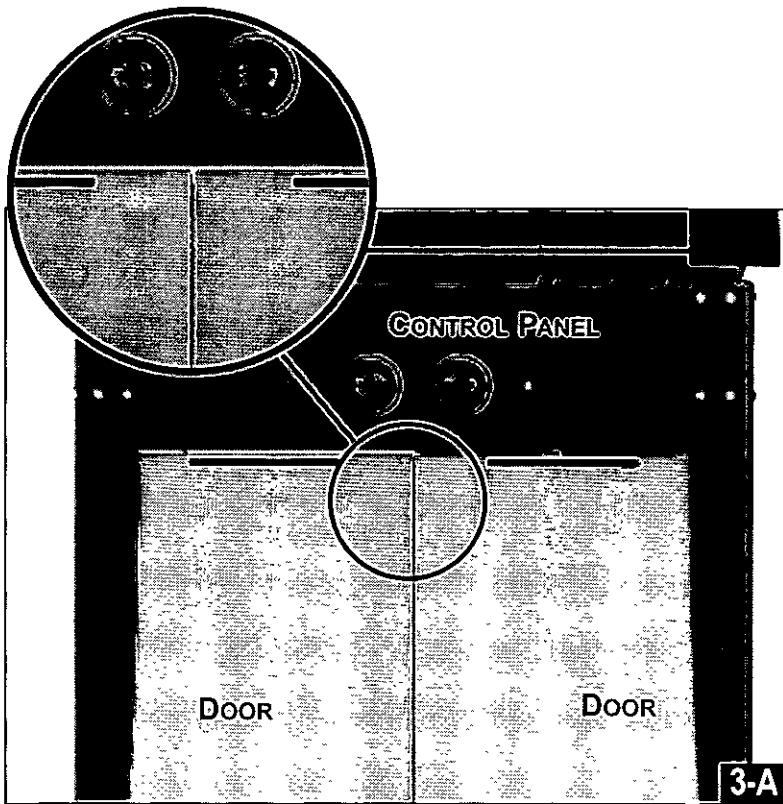

3-A. Check the alignment of the doors with the control panel.

- ⇒ In the unlikely event, the door alignment needs to be adjusted, follow the steps listed below.
- ⇒ If no adjustment is necessary, continue on with detail **4-A**.

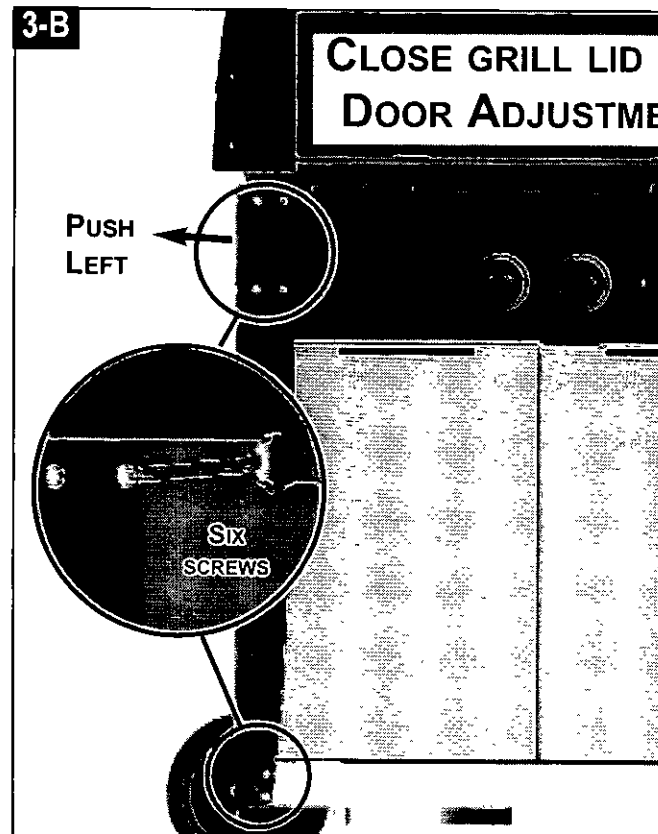

3-B. Loosen, the eleven front leg screws no r
Note: DO NOT REMOVE the screws.

- ⇒ At the top of the grill frame, gently push alignment of the doors.
- ⇒ Once the alignment is complete, re-tight bottom.

BEGIN WITH CARTON A - MISCELLANEOUS PARTS



- ⇒ The front doors are not shown for clarity of assembly.
- ⇒ Assemble WHEELS (16). See detail 4-A.
- ⇒ Assemble BASKET (22) on the right end of base and legs. See detail 4-B.

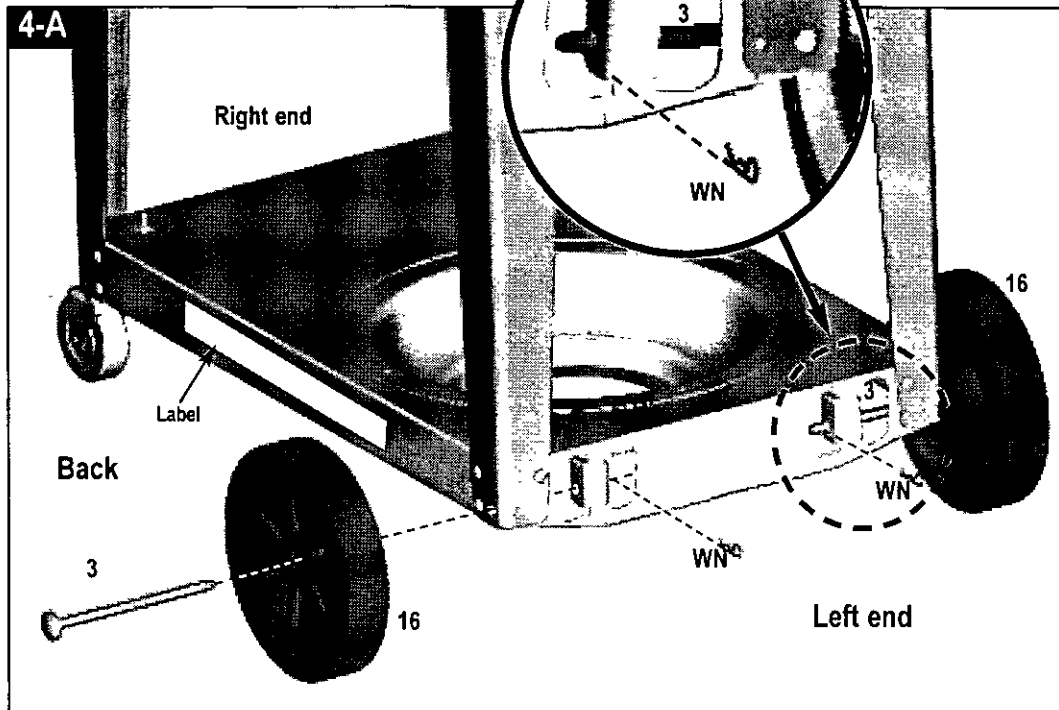

4-A. Insert the AXLE PINS (3) into the wheels.

- ⇒ Insert the wheels and axle pins into each side of the base and secure with two clevis pins (WN). See diagram.
- ⇒ Remove the remaining foam tray from under the barbecue grill now.

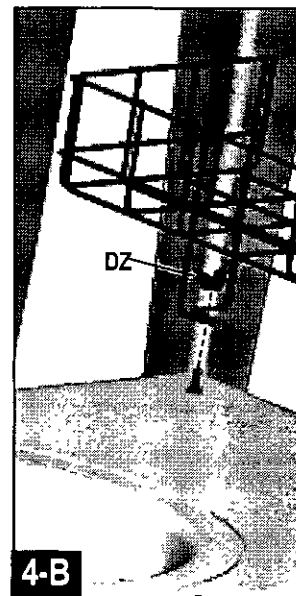

4-B

- 4-B. Feed the BASKET (22) into the base. The basket extensions on the base and legs will rest on the wheels.
- ⇒ Place the Basket (22) on the right end of the base with two wing nuts (WN).

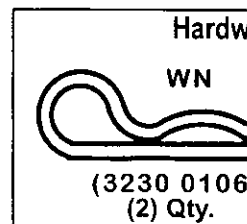

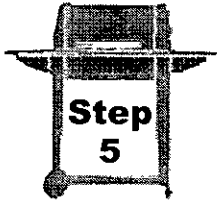

⇒ Assemble the two GREASE DRIP PANS (48) under the bottom casting and secure with the two GREASE PAN HANGERS (49). See detail 5-A.

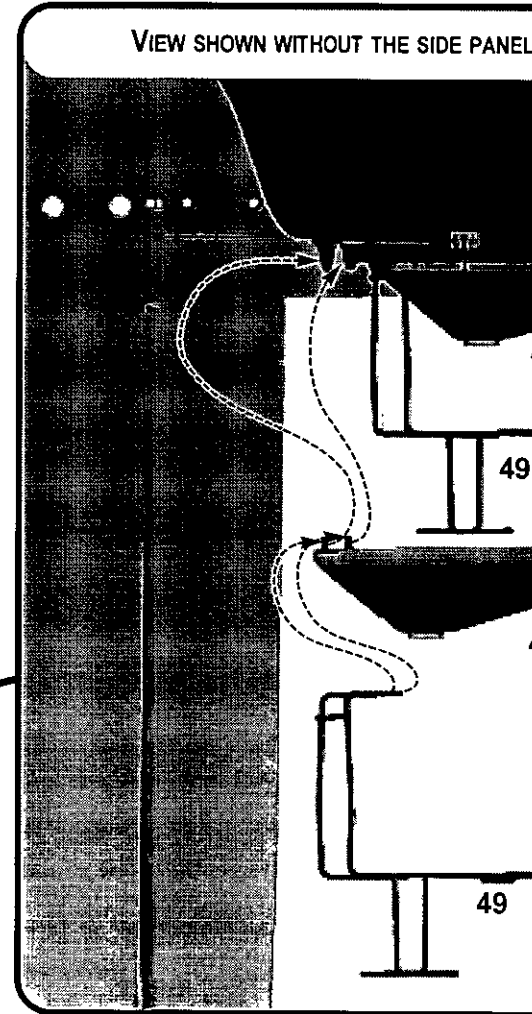
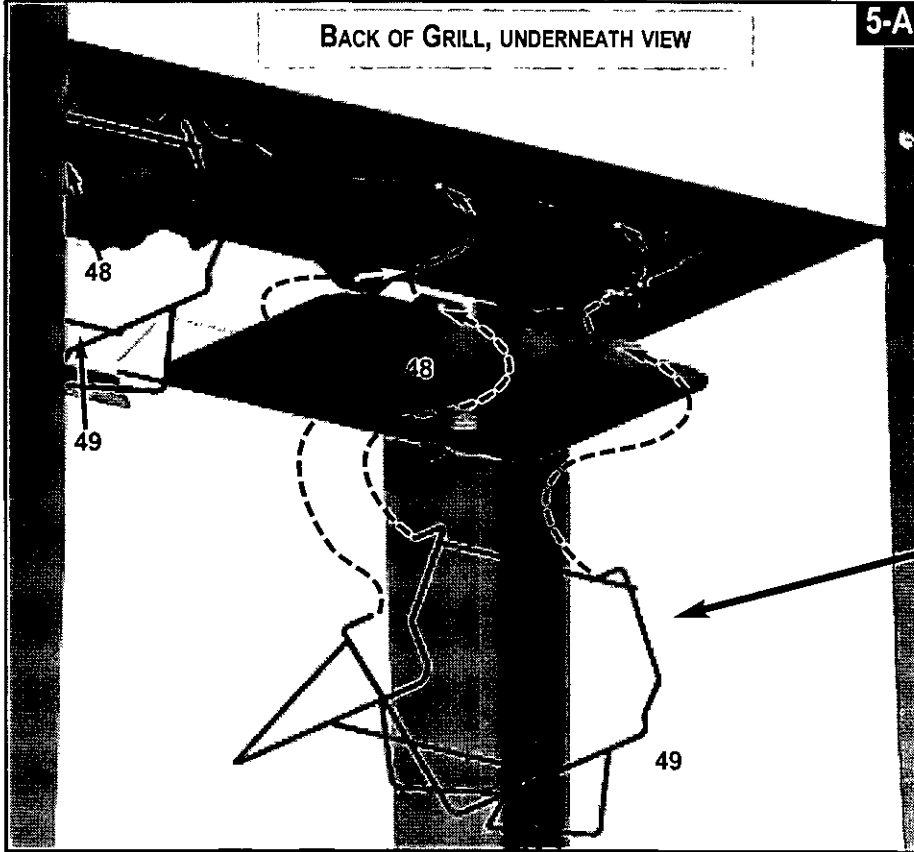

5-A. Align the holes in the GREASE PAN (48) with the holes underneath the Bottom casting. Secure the Grease Pan to the bottom casting with a GREASE PAN HANGER (49). Repeat the assembly for the other GREASE PAN and GREASE PAN HANGER

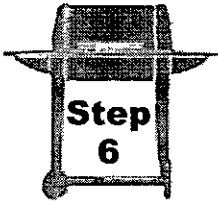

⇒ Assemble the two DISPOSABLE GREASE PANS (48a). See detail 6-A.

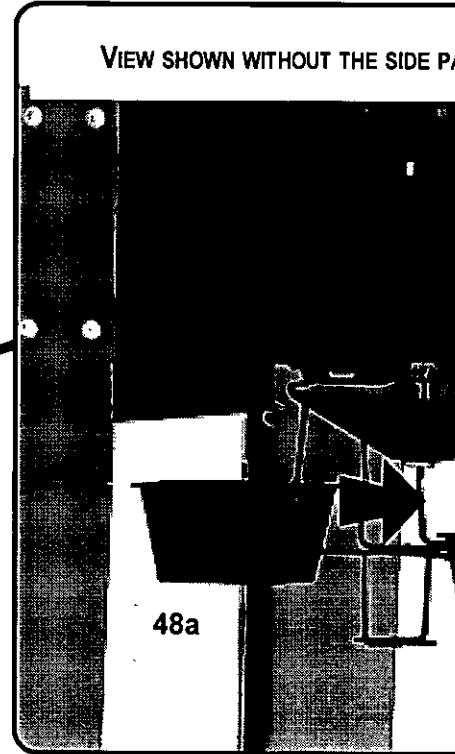
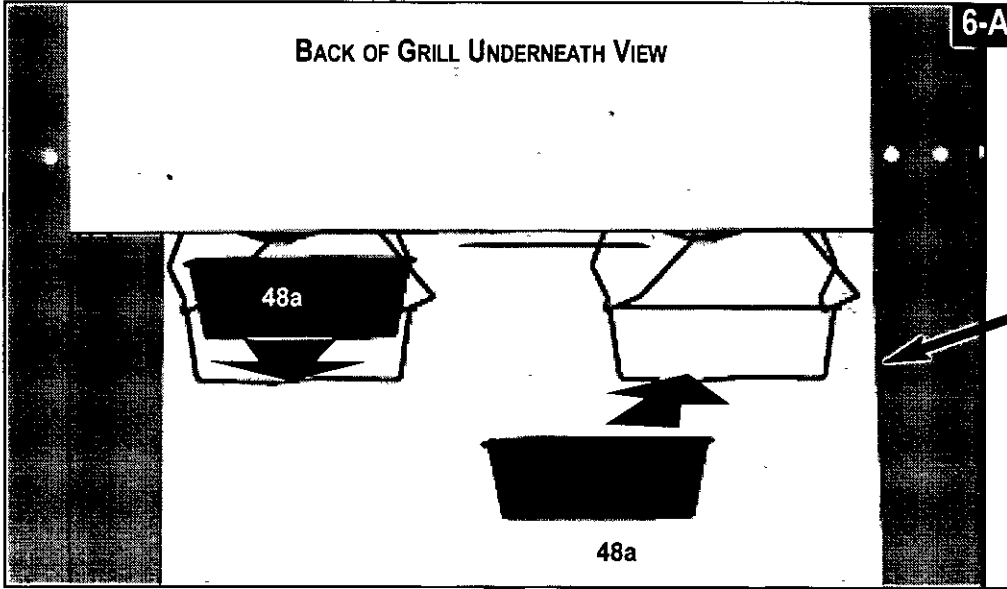

6-A. Place two DISPOSABLE GREASE PANS (48a) into the Grease Pan Hangers as shown.



⇒ Assemble CONTROL KNOBS (32), MEAT PROBE RECEPTACLE (57a) and MEAT PROBE (57) in detail

⇒ Assemble PERFORATED STAINLESS TENT (62). See detail 7-B.

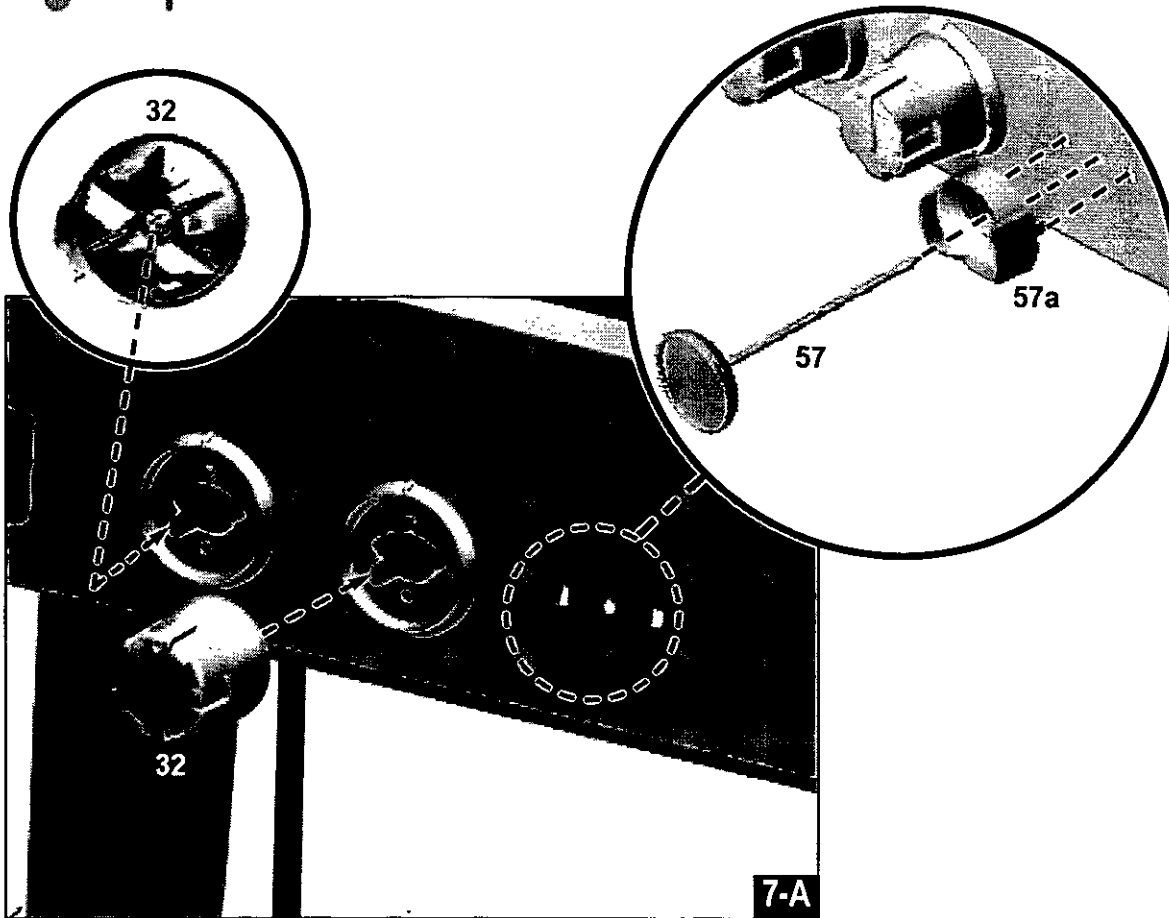

7-A. Place CONTROL KNOBS (32) on valve stems.

⇒ Insert MEAT PROBE RECEPTACLE (57a) into the right side of the control panel.

⇒ Place the MEAT PROBE (57) into the meat probe receptable.

7-B. Place the PERFORATED STAINLESS TENT (62) over the control panel.
the slots of the



- ⇒ Assemble FRONT HANDLE Assembly to the GRILL LID (55) in detail 8-A.
- ⇒ Assemble COOKING GRIDS (63) and WARMING RACK (65). See detail 8-B.

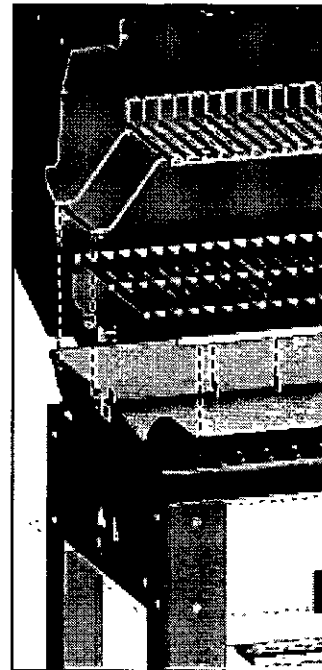
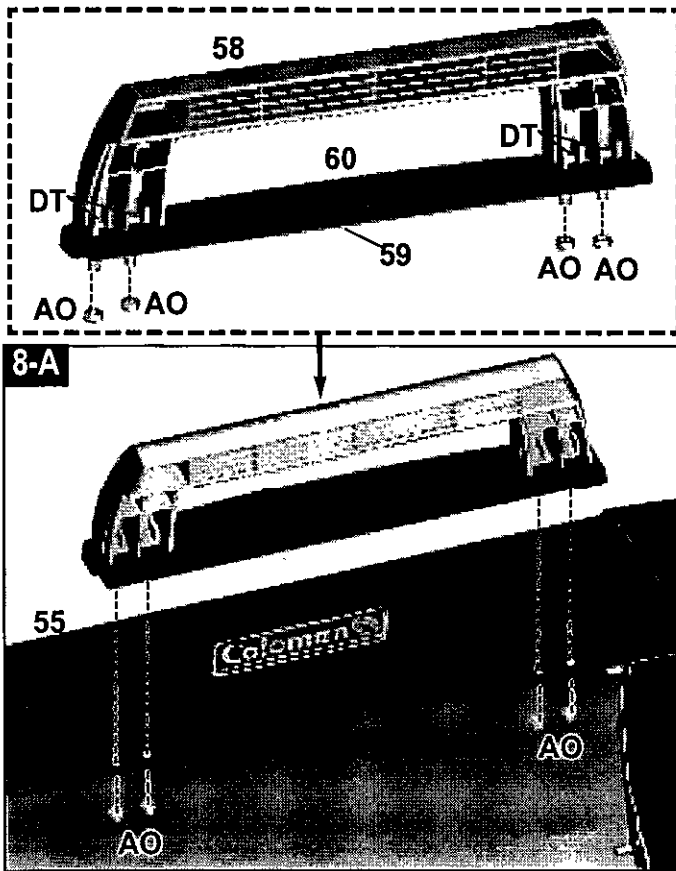

- 8-B. Place the COOKING GRIDS (63) and WARMING RACK (65) into the GRILL LID (55) with the smooth surface facing up.
- ⇒ Set the WARMING RACK (65) into the GRILL LID (55) casting.

8-A. The FRONT HANDLE (58), HANDLE SPACER (60), HANDLE INSULATOR (59), four screws (DT) and four hex nuts (AO) are PRE-ASSEMBLED at the factory.

- ⇒ Remove the four hex nuts (AO) from the Handle assembly.
- ⇒ Insert the screws in the Handle assembly into the GRILL LID (55) and secure with four hex nuts (AO).
- ⇒ Tighten with adjustable wrench or 7/16" wrench.

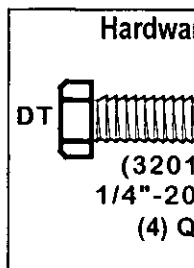

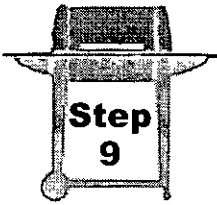

BEGIN WITH CARTON B - SIDE TABLE ASSEMBLIES

- ⇒ Assemble Pre-Assembled RIGHT SIDETABLE in detail 9-A.
- ⇒ Note: Use both hands and lift with side table brackets. **NEVER** lift with plastic parts.

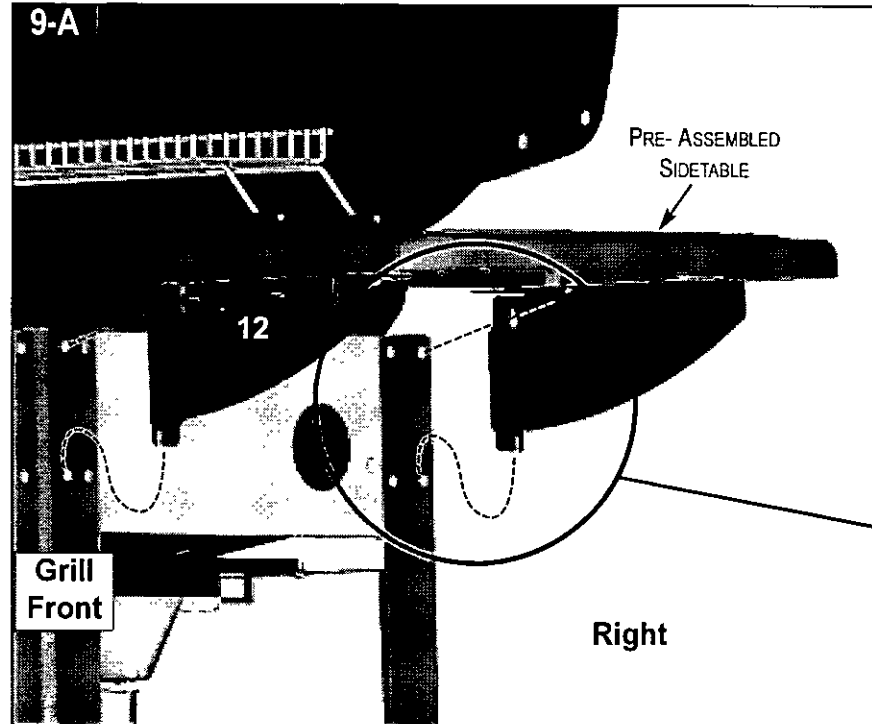

9-A. Use the 6-lobe screwdriver to back out the outside screws located in the top right legs (2 or 3 turns) just enough for the SIDE BRACKETS (11 and 13) on the PRE-ASSEMBLED sidetable, to slide in place.

⚠ CAUTION: DO NOT Remove screws completely.

⇒ Place the bottom slot of the brackets on the screws first and then the top slot. Note: The TOOL BAR (12) faces the front of the grill.

⇒ Gently slide the Bracket down and tighten screws.



STEPS 10, 11 AND 12 ARE FOR THE 3000 SERIES GRILL WITH TABLES. IF YOU HAVE A SIDE BURNER CONTINUE ON

- ⇒ Assemble Pre-Assembled LEFT SIDETABLE in detail 10-A.
- ⇒ Note: Use both hands and lift with side table brackets. NEVER lift with plastic parts.

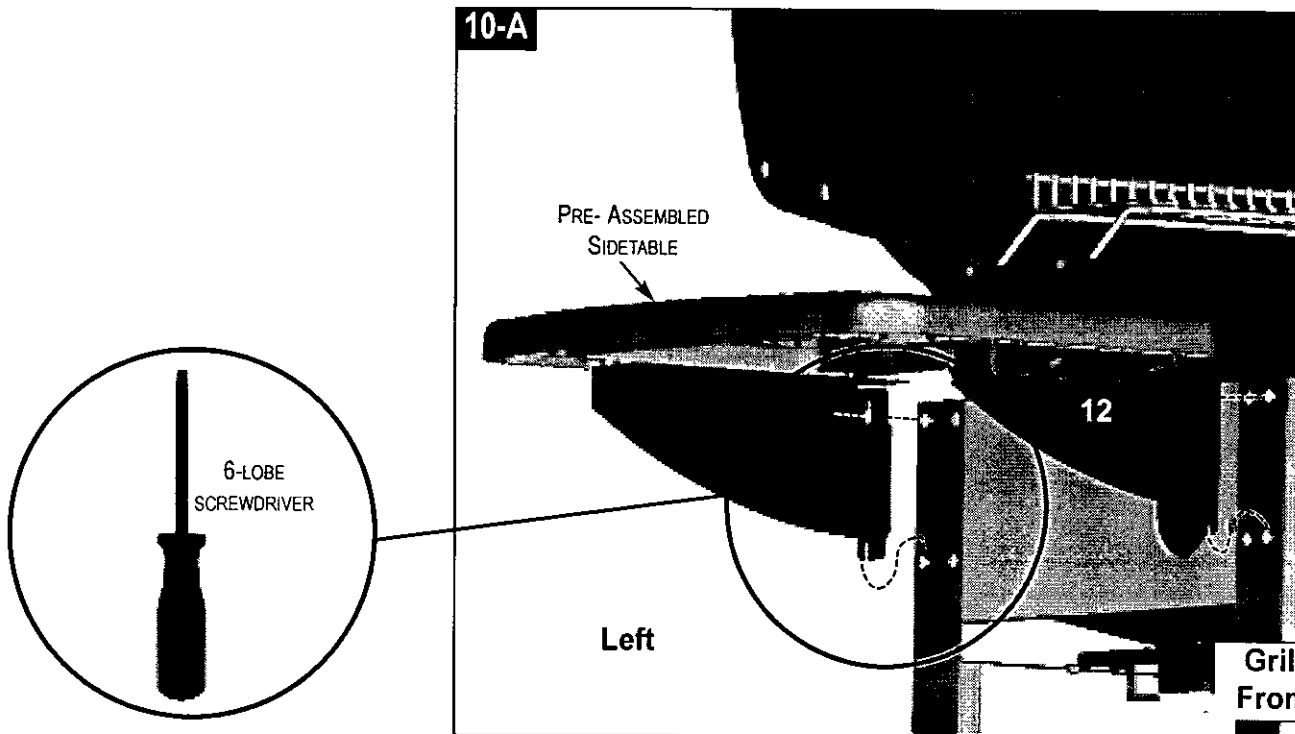

10-A. Use the 6-lobe screwdriver to back out the outside screws located in the left legs (2 or 3 turns) just enough for the SIDE BRACKETS (11) and the PRE-ASSEMBLED sidetable, to slide in place.

⚠ CAUTION: DO NOT Remove screws completely.

- ⇒ Place the bottom slot of the brackets on the screws first and then the Note: The TOOL BAR (12) faces the front of the grill.
- ⇒ Gently slide the Bracket down and tighten screws.

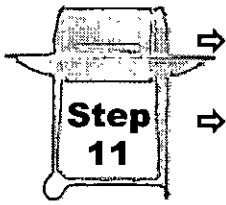

- ⇒ Assemble the ELECTRODE WIRES (29), SWITCH WIRES (26) and the 9-VOLT BATTERY (30) to the ELECTRONIC MODULE (28) in details 11-A.
- ⇒ Assemble the ELECTRONIC MODULE (28) under the Left Side Table in detail 11-B.

ELECTRONIC MODULE

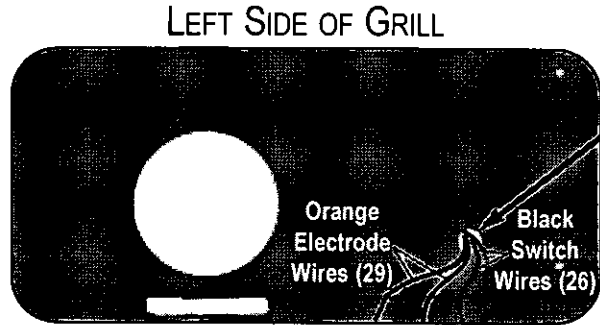
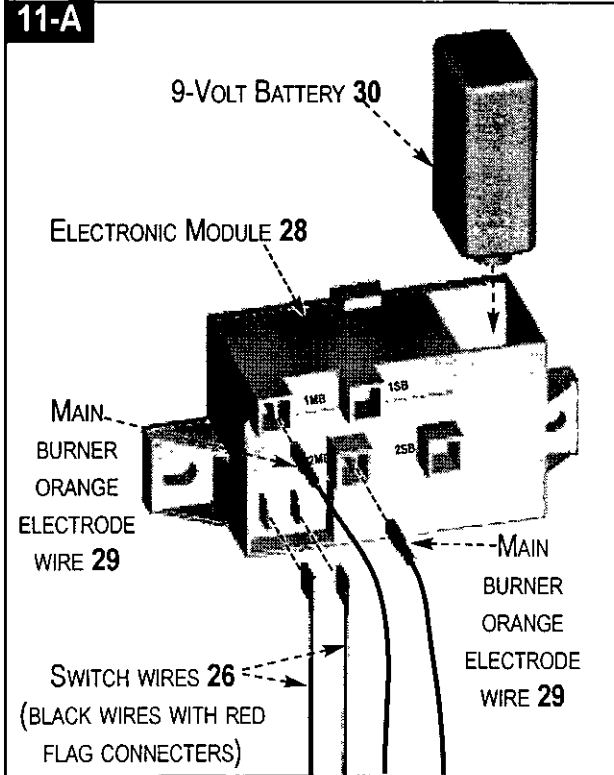

11-B. On the LEFT SIDE BRACKET, ATTACH THE ELECTRONIC MODULE (28) to the front bracket using the Mounting Screws (JS).

⇒ Bundle the wires as shown.

- 11-A. Attach the black SWITCH WIRES (26), with the red connectors located on the left side of your grill, to the two large pins on the ELECTRONIC MODULE (28). Then attach the two orange ELECTRODE WIRES (29) located on the left side of your grill, to the pins on the module marked 1MB and 2MB.
- ⇒ Insert the 9-VOLT BATTERY (30) in the module, it **MUST** snap in place.



Caution: Insure that the wires **DO NOT** touch hot surfaces such as the grill casting.

TEST THE IGNITER: A SPARK SHOULD APPEAR AT ELECTRODE TIP.

IF THE SPARK DOES NOT APPEAR:

- CHECK THE WIRE CONNECTIONS TO THE MODULE.
- CHECK PROPER ASSEMBLY OF FRESH 9-VOLT BATTERY.

Hardware shown actual size

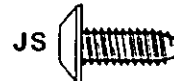

(3201 0199)
10-24 X 1/2"
(2) Qty.

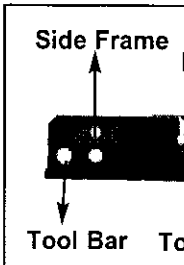



- ⇒ Assemble the CYLINDER (79) to the Cylinder caddy. See detail 12-A.
- ⇒ Place the CYLINDER RETAINER WIRE (77) over the Cylinder Collar. See detail 12-B.
- ⇒ Attaching TYPE 1 fitting to the fuel outlet valve in detail 12-C

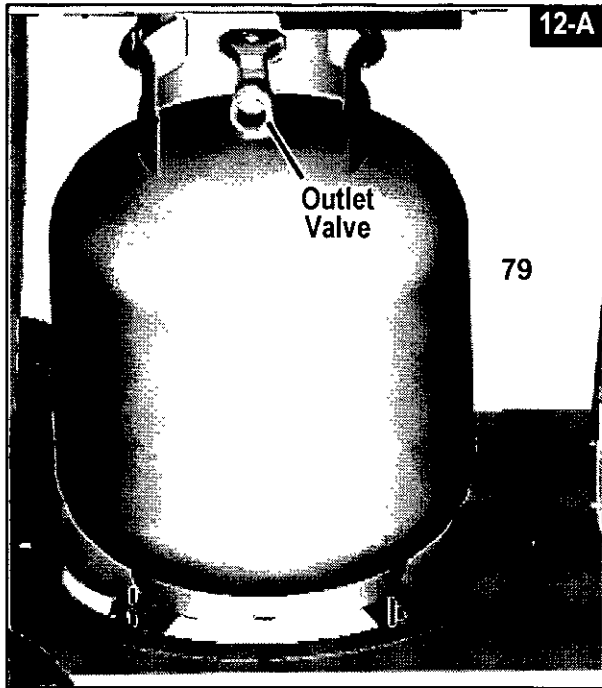

12-A Set CYLINDER (79) in the cylinder caddy with the outlet valve facing the front of the grill.

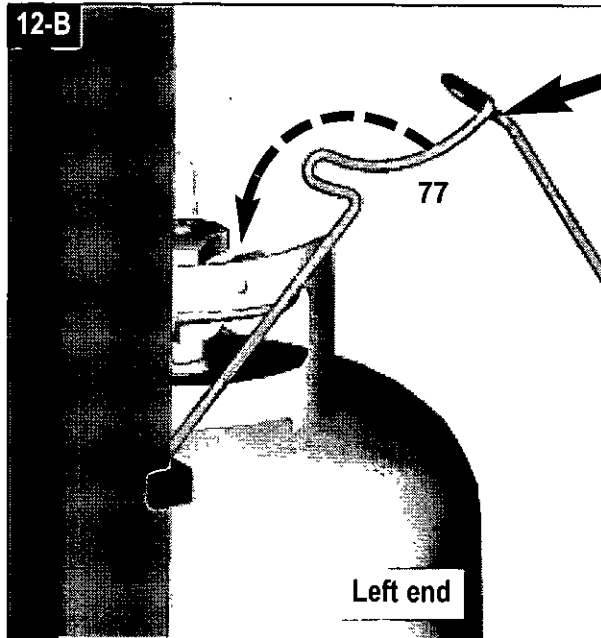

12-B Place the CYLINDER RETAINER WIRE (77) over the Cylinder collar, by rotating the wire from the original position toward the cylinder collar.



12-C Insert the TYPE 1 fitting into the fuel outlet valve. Turn the nut until it is tight. The nut wheel will provide a positive connection.

IMPORTANT!

TO ENSURE PROPER GAS FLOW, BURNER CONTROL VALVES MUST BE "OFF" BEFORE OPENING THE GAS CYLINDER VALVE.



WARNING: During assembly of grill and when attaching or replacing the L.P. gas cylinder, insure that the gas supply hose is free of kinks and/or damage and is at least 3" away from hot surfaces such as the grill casting.



STEPS 13, 14, 15 AND 16 ARE FOR THE 3000 SERIES GRILL BURNER. IF YOU HAVE TWO SIDE TABLES GO BACK

- ⇒ Attach the Side Burner assembly to the grill in detail 13-A.
- ⇒ Assemble the SIDE BURNER ELECTRODE with wires (8) in detail 13-B.
- ⇒ Note: Use both hands and lift with side table brackets. **NEVER** lift with plastic parts.

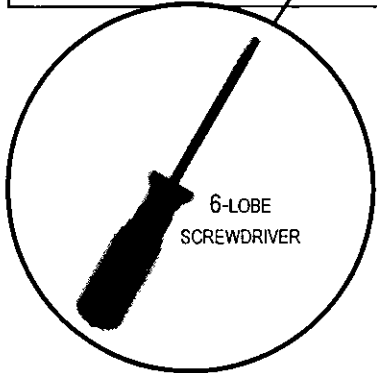
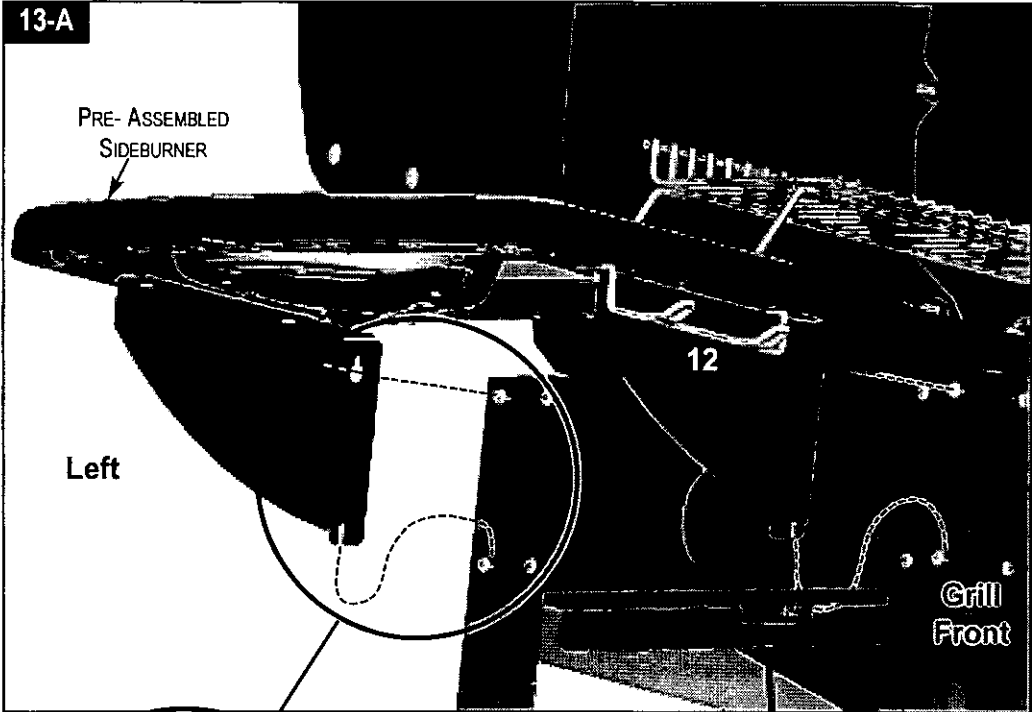

13-A. Use the 6-lobe screwdriver to back out the outside screws located in the top left legs (2 or 3 turns) just enough for the SIDE BRACKETS (11 and 13) on the PRE-ASSEMBLED side burner, to slide in place.

- ⚠ **CAUTION:** DO NOT Remove screws completely.
- ⇒ Place the bottom slot of the brackets on the screws first and then the top slot. Note: The TOOL BAR (12) faces the front of the grill.
- ⇒ Gently slide the Bracket down and tighten screws.



13-B. Thread the wires (8) through the electrode to...

Hardware sheet	
JS	(32)
	10-2
	(1)

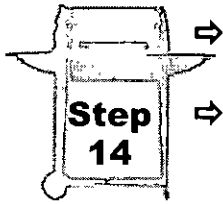

⇒ Assemble the IGNITER WIRES (lead ELECTRODE WIRES (29) and Side burner wires), SWITCH WIRES (26) and 9-VOLT BATTERY (30) in details 14-A.

⇒ Assemble the ELECTRONIC MODULE (28) in detail 14-B.

ELECTRONIC MODULE

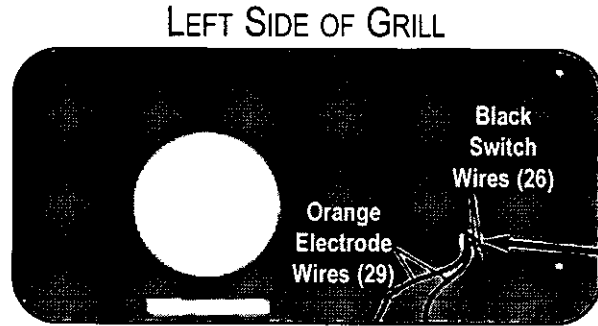
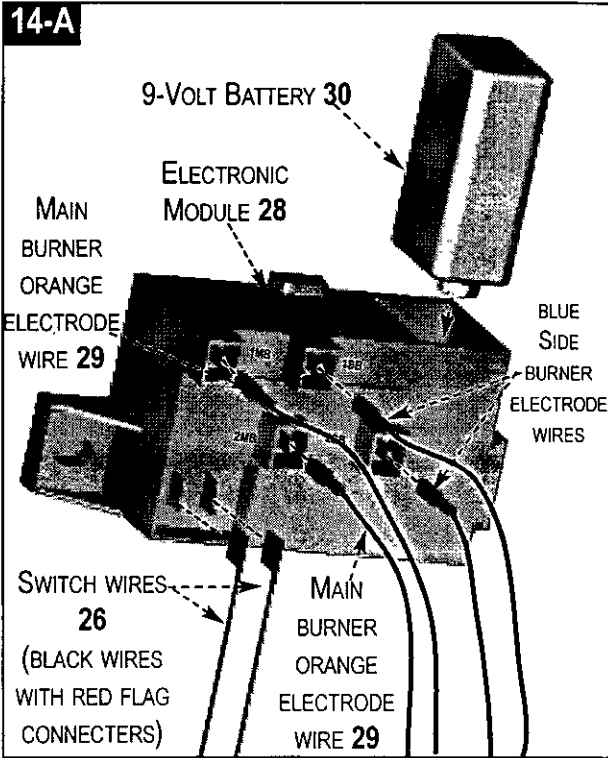

14-A. Attach the black SWITCH WIRES (26), with the red connectors located on the left side of your grill, to the two large pins on the ELECTRONIC MODULE (28). Then attach the two orange lead ELECTRODE WIRES (29) to the pins on the module marked 1MB and 2MB and the two blue Side Burner Electrode wires to the pins on the module marked 1SB and 2SB.

⇒ Insert the 9-VOLT BATTERY (30) in the module, it **MUST** snap in place.

⚠ **Caution:** Insure that the wires **DO NOT** touch hot surfaces such as the grill casting.

14-B. Locate the... attach the... underneath... holes indi...
⇒ Bundle ex... shown.

TEST THE IGNITER: A SPARK SHOULD APPEAR AT ELECTRODE TIP.
IF THE SPARK DOES NOT APPEAR:

- CHECK THE WIRE CONNECTIONS TO THE MODULE.
- CHECK PROPER ASSEMBLY OF FRESH 9-VOLT BATTERY.

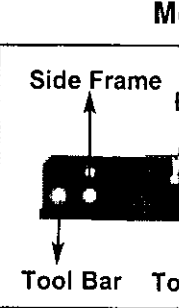
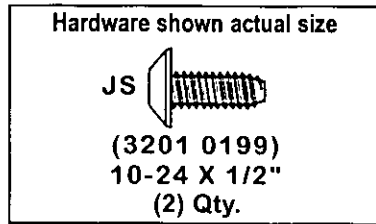

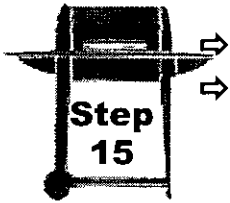

⇒ Assemble the SIDE BURNER VALVE (27) in detail 15-A.

⇒ Assemble the SIDE BURNER GRID (41) and the SIDE BURNER CONTROL KNOB (40) onto the Side burner.

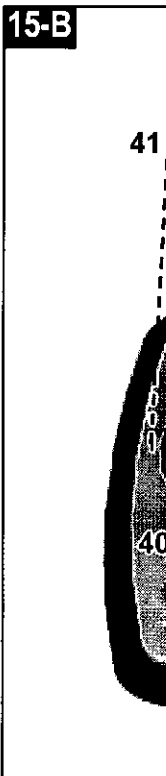
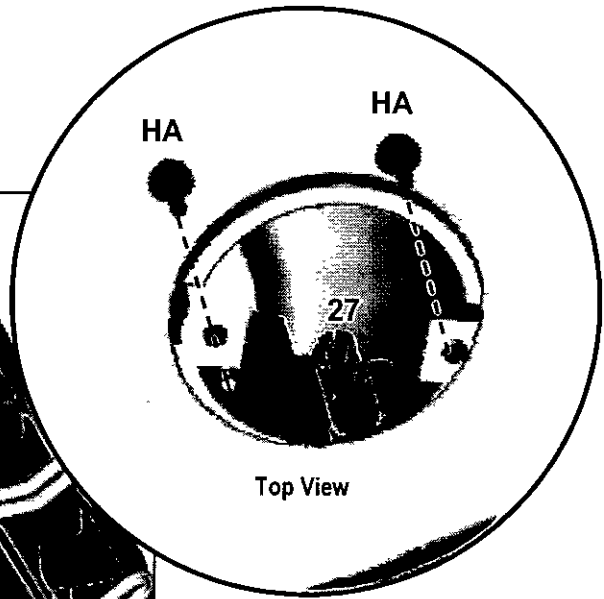
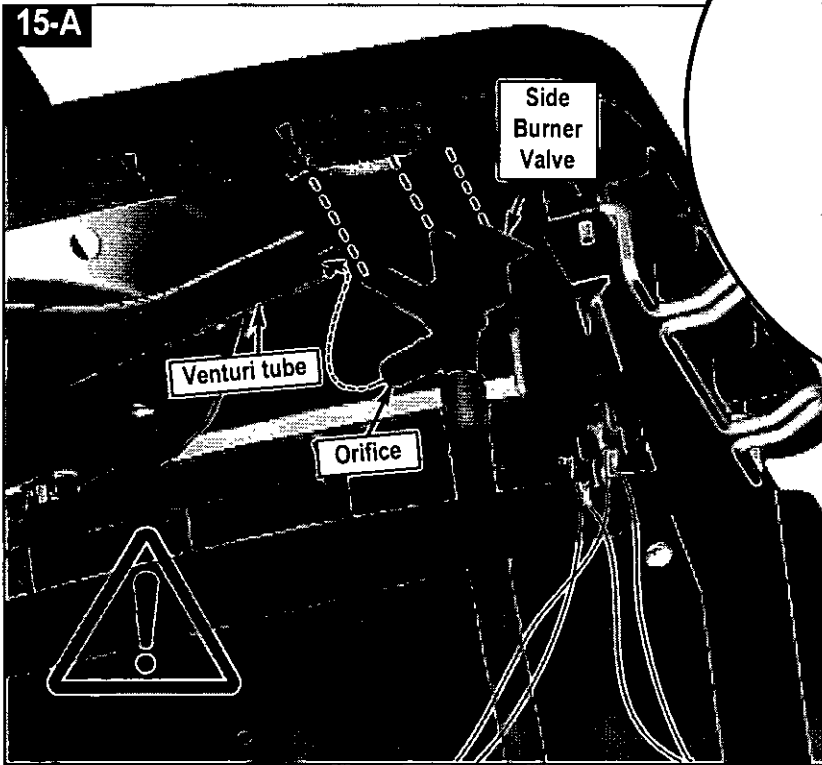

15-A. Attach the SIDE BURNER VALVE (27) (located on the Hose/Valve/Regulator assembly attach to the control panel) to the BASE with two screws (HA). Note: the Side burner hose must be thread between the left legs, not in front of the left leg.

⚠ **WARNING:** The orifice **must be** inside the venturi tube.

Hardware shown actual size



HA
(3250 0105)
#6-32 X 3/8"
(2) Qty.

15-B. Set the SIDE BURNER GRID (41) into the slots on the side burner. Turn the SIDE BURNER CONTROL KNOB (40) until it is secure.

⇒ Push the SIDE BURNER CONTROL KNOB (40) onto the SIDE BURNER VALVE (27).

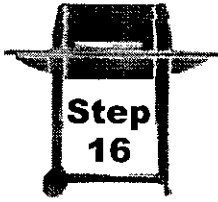

- ⇒ Assemble the CYLINDER (79) to the Cylinder caddy. See detail 16-A.
- ⇒ Place the CYLINDER RETAINER WIRE (77) over the Cylinder Collar. See detail 16-B.
- ⇒ Attaching TYPE 1 fitting to the fuel outlet valve in detail 16-C.

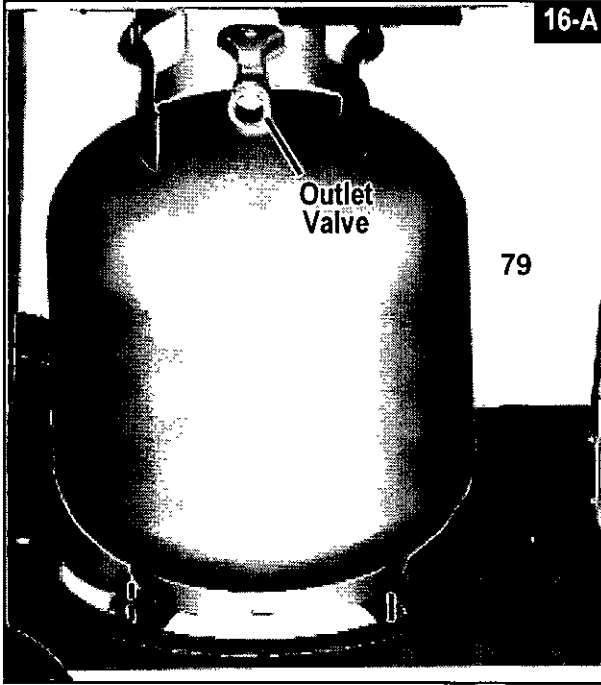

16-A Set CYLINDER (79) in the cylinder caddy with the outlet valve facing the front of the grill.

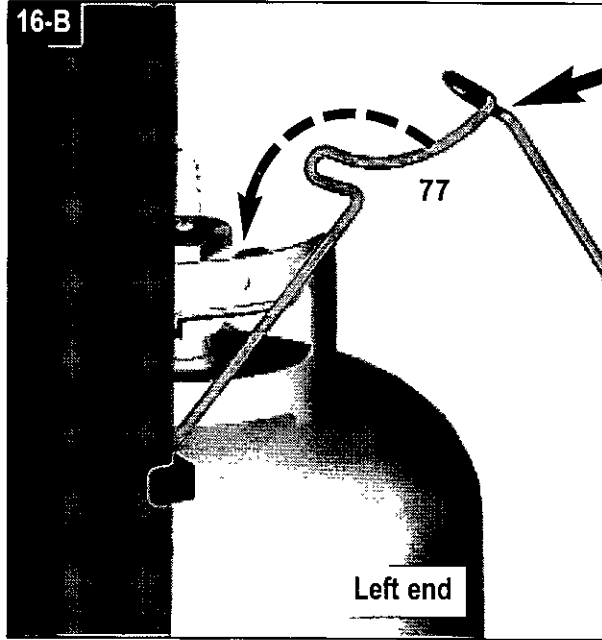

16-B Place the CYLINDER RETAINER WIRE (77) over the Cylinder collar, by rotating the wire from the original position toward the cylinder collar.

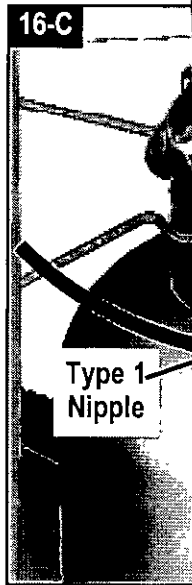

16-C Insert the nipple into the fuel outlet valve. Turn the nut tight. The nut wheel will provide a positive connection.

IMPORTANT!

TO ENSURE PROPER GAS FLOW, BURNER CONTROL VALVES **MUST** BE **"OFF"** BEFORE OPENING THE GAS CYLINDER VALVE.

⚠ WARNING: During assembly of grill and when attaching or replacing the L.P. gas cylinder, insure that the gas supply hose is free of kinks and/or damage and is at least 3" away from hot surfaces such as the grill casting.

COLEMAN GAS BARBECUE GRILL WARRANTY

CASTINGS - LIMITED LIFETIME

BURNER - LIMITED FIVE (5) YEARS

OTHER PARTS - LIMITED ONE (1) YEAR

The Coleman Company, Inc. ("Coleman") warrants that for the period that you own this product, it will be free from defects in material and workmanship. This warranty applies to the following parts for the following time periods: the castings are warranted for LIFETIME against burn through; the burner is warranted for five (5) years; and other parts are warranted for one (1) year, except the propane cylinder and paint finish. We **DO NOT WARRANT** in any way the propane cylinder (see label on cylinder for cylinder manufacturer's warranty) or the paint finish of the product. Coleman, at its option, will repair or replace this product or any component of the product found to be defective during the warranty period. Replacement will be made with a new or remanufactured product or component. If the product is no longer available, replacement may be made with a similar product of equal or greater value. This is your exclusive warranty.

This warranty is valid for the original retail purchaser from the date of initial retail purchase and is not transferable. Keep the original sales receipt. Proof of purchase is required to obtain warranty performance. Coleman dealers, service centers, or retail stores selling Coleman products do not have the right to alter, modify or any way change the terms and conditions of this warranty.

This warranty does not cover normal wear of parts or damage resulting from any of the following: negligent use or misuse of the product, use on improper voltage or current, use contrary to the operating instructions, disassembly, repair or alteration by anyone other than Coleman or an authorized service center. Further, the warranty does not cover Acts of God, such as fire, flood, hurricanes and tornadoes.

Coleman shall not be liable for any incidental or consequential damages caused by the breach of any express or implied warranty. Except to the extent prohibited by applicable law, any implied warranty of merchantability or fitness for a particular purpose is limited in duration to the duration of the above warranty. Some states, provinces or jurisdictions do not allow the exclusion or limitation of incidental or consequential damages or limitations on how long an implied warranty lasts, so the above limitations or exclusion may not apply to you. This warranty gives you specific legal rights, and you may also have other rights that vary from state to state or province to province.

DO NOT RETURN THIS PRODUCT TO THE PLACE OF PURCHASE.

Take the product to an authorized Coleman service center. You can find the nearest authorized Coleman service center by calling 1-800-356-3612. If a service center is not conveniently located, you may call the same number for instructions on shipping the product to the Coleman Company, Inc. You may also call the same number if you have any questions concerning this warranty.

NOT VALID IN MEXICO.

For WARRANTY, SERVICE and PARTS

Locate your model number and serial number on the label found on the back of your grill base.

CARE OF STAINLESS STEEL PARTS

- ⇒ BEFORE cleaning any part of the grill, allow the grill to cool down completely.
- ⇒ Clean the grill with any multipurpose metal polish or stainless polish, low in abrasive and with no phosphorus ingredients. (Read cleaner labels for suggested uses and directions on proper use of the cleaner.)
- ⇒ Use a soft cloth or sponge to prevent scratches and marring of the stainless steel surfaces.
- ⇒ NEVER USE OVEN CLEANERS.
- ⇒ To protect the integrity of your grill against the effects of the environment, use a grill cover when the grill is not in use.
- ⇒ Failure to comply with the owner's USE & CARE MANUAL INSTRUCTIONS & ASSEMBLY INSTRUCTIONS can void right of warranty.

BEFORE U

READ OWNER'S

- For proper filling
- For leak testing
- For correct grill
- For use and ste

⚠ WARNING!

cause injury if r
USE EXTREME

⚠ WARNING!

DO NOT smoke
DO NOT use fire

⚠ DANGER:

NEVER store a
grill body nor ins
of an explosion.

⚠ IMPORTANT

Be sure to tight
etc.) at least onc

Leak test g



COM

These assembl
more than one
shown MAY NO
provided by
pu

Notes

