

# Aussie™

## LP Gas Grill

# Assembly and Use Manual



**Bondi™ II**  
*Deluxe*



**Bondi™ II**  
*Elite*

For Customer Service, call 1-800-251-7558



- READ AND FOLLOW INSTRUCTIONS CAREFULLY BEFORE ASSEMBLY OR USE. FAILURE TO FOLLOW THESE INSTRUCTIONS COULD RESULT IN DEATH, SERIOUS BODILY INJURY AND/OR PROPERTY LOSS.
- FOR HOUSEHOLD OUTDOOR USE ONLY. NOT FOR COMMERCIAL USE.
- SOME PARTS MAY CONTAIN SHARP EDGES-ESPECIALLY WHERE NOTED IN THIS MANUAL! WEAR PROTECTIVE GLOVES IF NECESSARY.
- THESE INSTRUCTIONS MUST BE KEPT WITH THE CONSUMER AND RETAINED FOR FUTURE USE.

### FOR YOUR SAFETY

If you smell gas:

1. Shut off gas to the appliance.
2. Extinguish any open flame.
3. Open lid.
4. If odor continues, immediately call your gas supplier or your fire department.

### FOR YOUR SAFETY

1. Do not store or use gasoline or other flammable vapors and liquids in the vicinity of this or any other appliance.
2. An LP cylinder not connected for use shall not be stored in the vicinity of this or any other appliance.

I. IMPORTANT SAFEGUARDS.....	2	C) Operating the LP Gas Grill.....	16
II. Parts Diagram.....	5	1) Preparation Before Cooking.....	17
Parts List.....	6	2) Lighting with Igniter.....	17
Step 1 - Cart Assembly.....	8	3) Lighting the Side Burner.....	18
Step 2 - Attach Axle & Wheels.....	8	4) Manual Lighting of the Grill.....	19
Step 3 - Mount Body Onto Cart.....	9	5) Check Your Flame.....	20
Step 4 - Mount Side Tables.....	9	6) Grill Cooking.....	20
Step 5 - Mount Rear Brace.....	10	7) Roasting.....	20
Step 6 - Attach Hood Handle & Shield.....	10	8) End of Cooking Session.....	20
Step 7 - Attach Flavor Activator™.....	10	9) Turning Off Your LP Gas Grill.....	20
Step 8 - Attach Privacy Panel.....	11	D) Care and Maintenance.....	20
Step 9 - Insert Cooking Grid.....	11	1) Porcelain Coated Cooking Surfaces.....	21
Step 10 - Attach LP Cylinder.....	12	2) Burner Maintenance.....	21
Step 11 - Leak Test.....	13	3) Flavor Activator.....	22
III. Operating and Maintaining Your LP Gas Grill.....	14	4) Drip Cup.....	22
A) Gas, Cylinder, Hose and Regulator Info.....	14	5) Cleaning the Grill Body.....	22
1) LP Hose & Regulator Assembly.....	14	6) Preventive Maintenance.....	22
2) LP Gas Cylinder.....	14	7) Storage.....	22
3) Connect/Disconnect LP Gas Cylinder.....	14	IV. Troubleshooting.....	23
B) Before Using Your Grill.....	15	V. Important Notice - LP Cylinder with OPD.....	25
1) Selecting a Location.....	15	VI. Limited Warranty.....	26
2) Precautions.....	15		
3) Leak Testing.....	16		

# IMPORTANT SAFEGUARDS

## ▲ DANGER!

**FAILURE TO FOLLOW THESE SAFEGUARDS COULD RESULT IN DEATH, SERIOUS BODILY INJURY, AND/OR PROPERTY LOSS. READ AND FOLLOW ALL INSTRUCTIONS CAREFULLY BEFORE ASSEMBLY OR USE OF THE LP GAS GRILL.**

1. **▲ WARNING!** Read and follow all instructions.
2. For Household Outdoor Use Only -  
Do Not Use Indoors or on recreational vehicles or boats. Never use as a space heater. Not for commercial use.
3. **▲ WARNING!** To reduce the risk of serious or fatal injury from breathing toxic fumes and from explosion and fire as a result of leaking gas, use only outdoors in an open area with good ventilation. As with all conventional fuels, the burning process consumes oxygen and produces toxic gases, including carbon monoxide. In addition, the combustion products of such fuels, including liquefied petroleum (LP), contain chemicals known to the state of

California and other authorities to cause cancer, birth defects and other reproductive harm.

4. Place your Liquefied Petroleum (LP) gas grill on a firm, level surface. Grill should be setup away from high traffic areas and combustible materials.
5. Locate your LP gas grill at least 10 feet away from your house or any building. Do not use the grill in a garage, breezeway, carport, porch, or in any enclosed area. Do not locate this appliance under overhead unprotected combustible surfaces.
6. Have an ABC fire extinguisher accessible. Never attempt to extinguish a grease fire with water or other liquids.

7. **▲ WARNING!** If your grill catches on fire:
  - If the fire is in the grill portion and you can safely reach the control knobs, then turn them off by turning knobs clockwise. If you cannot safely reach the control knobs, call the fire department.
  - If the fire involves one of the hoses, and you can safely reach the propane cylinder valve, shut the valve off by turning LP cylinder valve handle clockwise to a full stop.
  - If the fire involves the cylinder, leave it alone, evacuate the area and call the fire department.
  - If there is any type of fire that threatens either personal safety or endangers property, call the fire department.
8. Check the Grease Cup for grease buildup. Remove excess grease to avoid a grease fire in the pan. **Never use the grill without Grease Cup in place.**
9. **▲ WARNING!** If you notice grease or other hot material dripping from the grill onto valve, hose, or regulator, turn off gas supply immediately. After the grill has cooled, determine the cause and correct it. After cleaning the valve, hose and regulator, perform a leak test before continuing use. See **Before Using Your LP Gas Grill** section (page 29) of this manual for correct leak test procedures.
10. This installation must conform with local codes or, in the absence of local codes, with either the National Fuel Gas Code, ANSI Z223.1, or CAN/CGA-B149.2, Propane Installation Code.
11. If an external electrical source is utilized, the outdoor cooking appliance, when installed, must be electrically grounded in accordance with local codes or, in the absence of local codes, with the National Electrical Codes, ANSI/NFPA 70, or the Canadian Electrical Code. CSA C22.1.
12. Keep any electrical supply cord and the fuel supply hose away from any heated surfaces. Electric cords should be placed away from walkways to avoid a tripping hazard.
13. Combustible materials should never be within 36 in. of the back or sides of your LP gas grill.
14. **▲ WARNING! Always Store Lp Cylinders upright and where temperatures do not exceed 125 degrees Fahrenheit. Never store a spare or disconnected LP cylinder under or near this LP gas grill.**
17. Check the LP gas grill for gas leaks and burner obstructions before each use.
 

**▲ WARNING! Do not use a flame to check for gas leaks.** See **Before Using Your LP Gas Grill** section of this manual for correct leak test procedures. A clogged burner tube can lead to a fire beneath grill.
18. **▲ DANGER!** If you see, smell, or hear the hiss of escaping gas from the LP cylinder:
  - A. Get away from the cylinder.
  - B. Do not attempt to correct the problem yourself.
  - C. Call your local fire department.
19. **▲ WARNING! Do not operate an LP gas grill if you have knowledge of or suspect a gas leak.**
20. Always inspect the gas hose and regulator assembly before each use. Always turn the LP cylinder to the "Off" position before inspecting parts. If the hose is cut, damaged, or showing signs of excessive abrasion or wear, do not use the LP gas grill. Contact the manufacturer, as the hose must be replaced with an assembly specified by the manufacturer prior to further use of the LP gas grill.
21. **▲ WARNING!** Before lighting the LP gas grill, open the hood to prevent an explosion from gas build-up. See Operation of Your LP Gas Grill section
22. If burner does not light, turn off all gas control knobs. Leave the grill hood open and wait five minutes before attempting to light.
23. If burner goes out during operation, turn off all gas control knobs. Open the hood and wait five minutes before attempting to light.
24. Exercise reasonable care when using this LP gas grill. Never leave grill unattended during use or cleaning.
25. Never allow children to operate or play near an LP gas grill. Keep animals and bystanders out of the grill area.
26. Always turn off the LP gas cylinder at the cylinder valve when not in use. Allow grill to cool before handling parts or cleaning.
27. **▲ WARNING!** Do not move an LP gas grill when in use or hot.
28. **▲ WARNING!** Never touch hot surfaces. Use heat resistant gloves, long-handled tongs, or cooking mitts at all times. The grill will become very hot. Open the hood carefully when cooking to avoid burns from the hot air and steam trapped inside.
29. Use only the hose and regulator assembly that is supplied with your LP gas grill and/or specified by the manufacturer.

30. Use of this LP gas grill other than for the intended use, or alteration of LP gas grill in any way may not be safe and will void any warranty.
31. Never attempt to repair the LP gas grill or cylinder yourself. Contact the manufacturer for information regarding repairs to your grill.
32. LP gas is not natural gas. The conversion or attempted use of natural gas in an LP unit or LP gas in a natural gas unit is dangerous and will void your warranty.
33. Do not use charcoal in an LP gas grill. Do not use aerosols or store flammable liquids or materials near this LP gas grill.
34. **▲ WARNING!** Do not wear loose clothing (for example: hanging shirt tails, clothing with frills, etc.) around an LP gas grill while in use or hot.
35. Never use an LP cylinder if it shows signs of: dents, gouges, bulges, fire damage, corrosion, leakage, excessive rust or other forms of visual external damage; it may be hazardous and should be checked by a Liquefied Petroleum supplier. Do not use an LP cylinder with a damaged valve.
36. Even though your LP cylinder may appear to be empty, gas may still be present and the cylinder should be transported and stored accordingly.
37. Never store an LP gas cylinder indoors (empty or filled). If storing the gas grill indoors, disconnect LP gas cylinder and store it outdoors out of the reach of children.
38. Never leave an LP cylinder inside a vehicle which may become overheated by the sun.
39. Never lean your body over the LP gas grill when lighting it or while it is in use or hot.
40. Do not attempt to disconnect, move or alter any gas fittings while your LP gas grill is in operation.
41. Your LP gas grill should be cleaned on a regular basis. Refer to Care and Maintenance section in this manual.
42. This LP gas grill is not designed to be used with a solid plate (griddle). Full coverage of plates will cause excessive heat and could damage the grill.
43. Never douse the grill with water when its surfaces are hot because it may cause grease to splatter or the porcelain cooking grids and hood to break.
44. When not in use, the LP cylinder valve must be turned to "Off" position.

**— NOTICE —**

**AUSSIE GRILL COMPANY STRIVES TO BE A QUALITY SUPPLIER OF CONSUMER PRODUCTS. IF WE INADVERTENTLY OMITTED ANY PARTS NEEDED FOR ASSEMBLY, OR YOU NEED TROUBLESHOOTING INFORMATION, PLEASE CONTACT US USING OUR TOLL FREE NUMBER. THANK YOU FOR PURCHASING AN AUSSIE GRILL COMPANY PRODUCT.**

1-(800)-251-7558  
 8 am - 5 pm E.S.T Mon. - Fri.  
 1-(423)-639-1171 (TELEPHONE)  
 1-(423)-639-2570 (FAX)

**CONSUMER SERVICE DEPARTMENT  
 AUSSIE GRILL COMPANY  
 1500 INDUSTRIAL ROAD  
 GREENEVILLE, TN. 37745 USA**

**[www.aussiegrill.com](http://www.aussiegrill.com)**

**Parts Diagram** - Some small parts may not be depicted

11

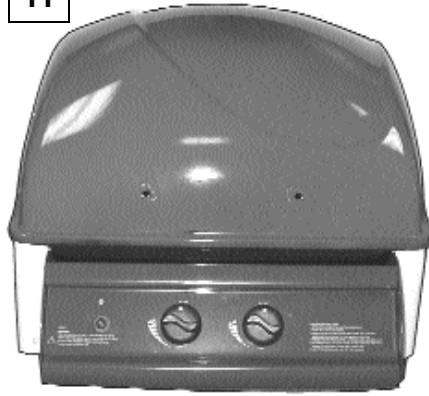

18



13



14

29



12



17



20



19

16

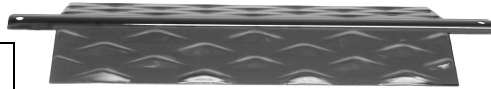

10



15



3



4



1



2

6

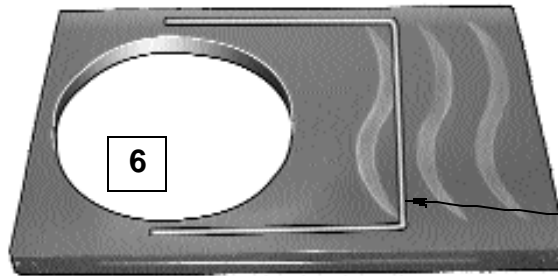

5



9



7



24



8

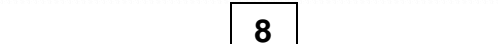

## ASSEMBLY INSTRUCTIONS for BONDI II DELUXE & BONDI II ELITE MODELS

**PREPARATION FOR ASSEMBLY: Removing parts from carton and some assembly will require two people.** Before starting assembly, read the instructions and your manual.

This manual covers several Bondi Grill models. Use only the steps that pertain to your model. Remove all the parts from the carton and lay them on a smooth, clean surface. (You may cut the carton, spread it out, and use it as a pad to protect part finishes.) Look in the Parts List below under your model number to find the exact parts you need. Do not throw away any packaging until you have located all the parts.

Follow instructions of each step in the order they are written as you look at the diagrams. This will allow little confusion and easier assembly.

If you have any questions which require help, contact Customer Service and be sure to mention the model number of your grill.

<u>PART/ DESCRIPTION</u>	<u>PART#</u>	<u>BONDI II DELUXE</u>	<u>BONDI II ELITE</u>
1 Front Leg, Fixed	03.6161.00	1	1
2 Rear Leg, Fixed	03.6162.00	1	1
3 Front Leg, Wheel	03.6163.00	1	1
4 Rear Leg, Wheel	03.6164.00	1	1
5 Clip, Cylinder Retainer	03.6205.01	1	1
6 Bottom Shelf	03.6165.00	1	1
7 Wheel	03.6214.00	2	2
8 Axle	03.6215.01	1	1
9 Wheel Cover	03.6217.01	2	2
10 Rear Support Brace	03.6166.00	1	1
11 Body Assembly	03.6167.00	1	1
12 Hood Handle	03.6168.00	1	1
13 Left Side Table w/Perforations	03.6169.00	1	

	<b><u>PART/ DESCRIPTION</u></b>	<b><u>Part#</u></b>	<b><u>BONDI II DELUXE</u></b>	<b><u>BONDI II ELITE</u></b>
14	Right Side Table w/Perforations	03.6170.00	1	1
15	Privacy Panel	03.6172.00	1	1
16	Flavor Activator <sup>TM</sup>	03.6250.00	1	1
17	Warming Rack	03.6253.00	1	1
18	Cooking Grid, Porcelain	03.6255.00	1	1
19	Hood Shield	03.6289.00	1	1
20	Left Side Table with Side Burner	03.6171.00		1
21	Screw, M5 X 35	03.4099.00	8	8
22	Washer M6	03.4095.00	2	2
23	Nut, M6	03.4098.00	4	4
24	Nut, M8	03.6216.00	2	2
25	Screw, M6 x 20	03.4096.00	6	6
26	Screw, M6 X 35	03.6219.01	4	4
27	Screw, M6 X 70	03.4097.00	2	2
28	Screw, M6 X 75	03.4094.00	2	2
29	Handle Spacer	03.6023.00	2	2

**STEP 1- Cart Assembly**

**ITEM 21 M5 X 35 SCREW 8 pcs**  
Actual Size

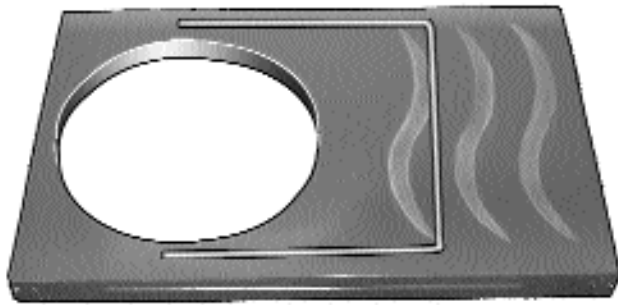

**ITEM 6 Bottom Shelf**

•Using eight M5 X 35 screws, attach the Legs to the Bottom Shelf as shown.

**TOOLS:**

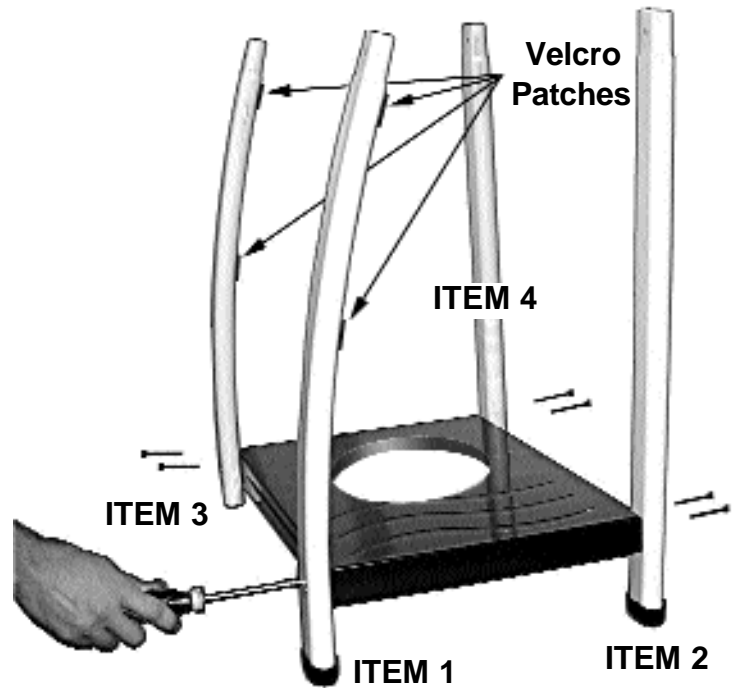

**Step 2 - Install Axle, Wheels & Wheel Covers:**

**TOOLS:**

Push Axle (item 8) through holes in front and rear legs. Place wheels (Item 14) on the axle. Secure with two M8 Nuts (Item 24) and tighten with wrench or pliers as shown.

Align Wheel Cover pins into holes on Wheel and snap in place.



**Item 8 Axle 1 pc**



**Item 24 Nut, M8 2 pcs**

**Item 7 Wheel 2 pcs**

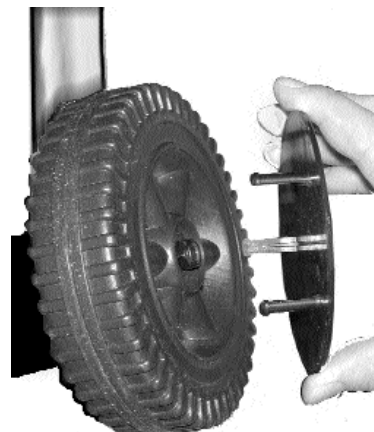
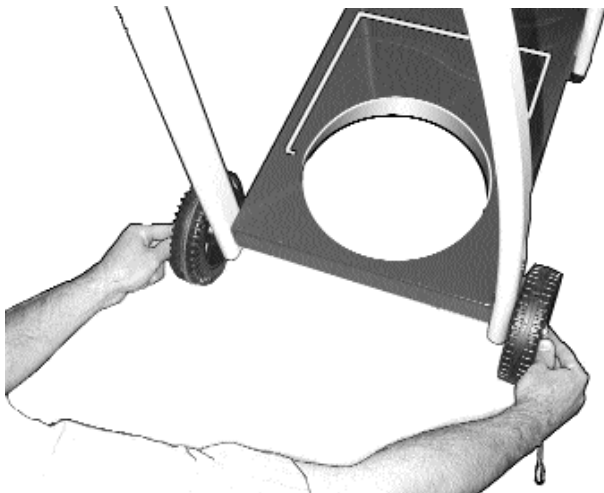
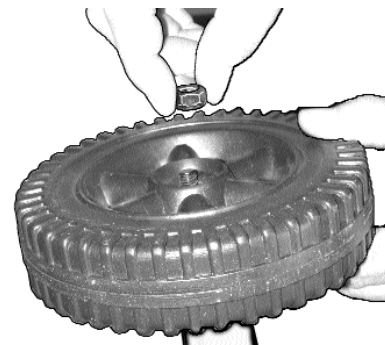



### Step 3 - Mount Body onto Cart

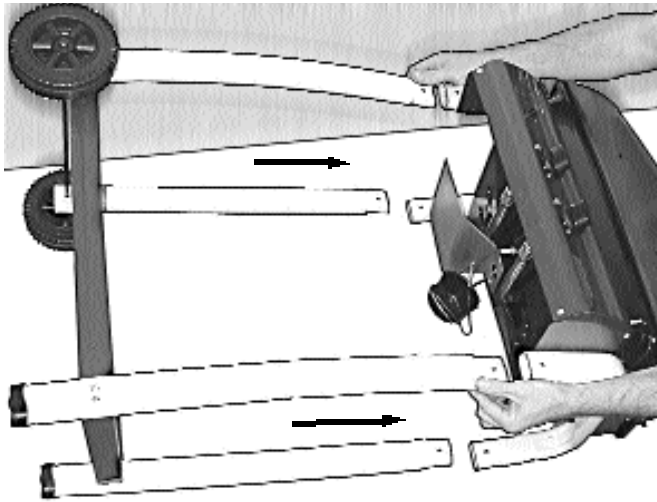

Lay Cart and Body on its backside. Align Cart legs with Body legs and press together until screw holes align.

It may be necessary to stand grill up after the legs start together and press firmly into final position.

Secure using 4 M6X35 screws & nuts.



Item 26 Screw, M6X35  
4 pcs Actual Size



Item 23 Nut, M6  
4 pcs

### STEP 4 - Mount Side Tables



Assemble Right Side Table (Item 14) to Frame with 3 M6X20 Screws. Use two Screws at Front Leg and one Screw in the upper hole of the Rear Leg.



Item 25 Screw, M6X20  
3 pcs Actual Size

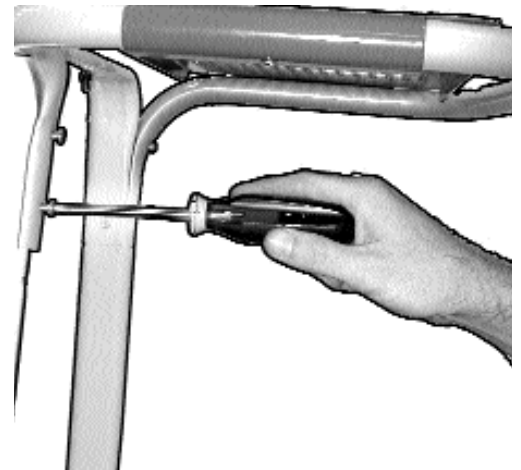

Assemble Left Side Table (Item 13 or Item 20, depending on your grill model) to Frame with 3 M6X20 Screws. Use two Screws at Front Leg and one Screw in the upper hole of the Rear Leg.



Item 25 Screw, M6X20 3pcs  
Actual Size

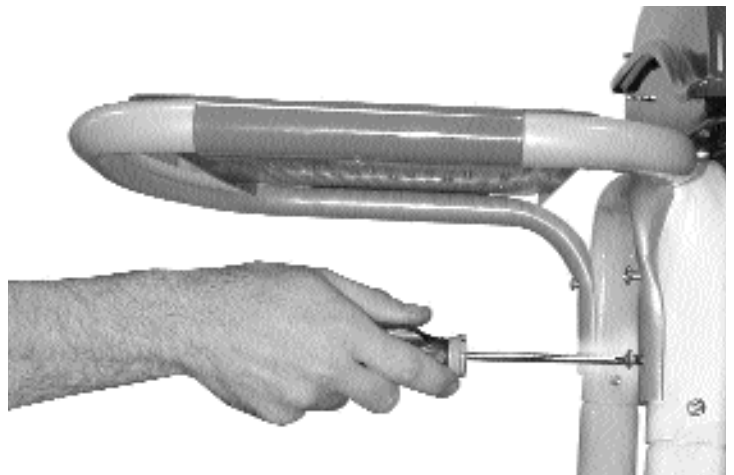

**Step 4 Continued - Mount Side Tables**

**Elite Model Only:  
Side Burner Table**



**Step 5 - Mount Rear Brace**

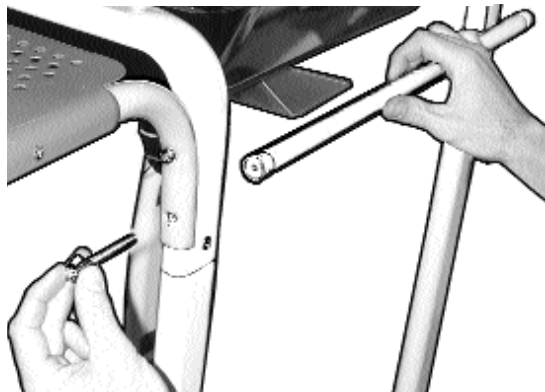
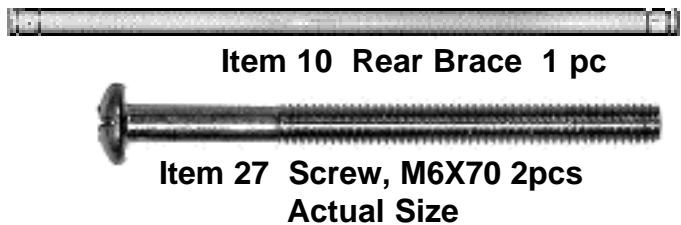

**Mount Rear Brace (Item 10) to rear legs using 2 M6X70 Screws through lower holes on rear Side Table mount.**

**STEP 6 - Attach Hood Handle and Shield**

•From Inside Hood, Insert M6X75 (Item28) Screw through Hood Shield (Item 19), then through Hood and Hood Handle Spacer into Handle. Repeat for other side of Handle. **NOTE: DO NOT Overtighten mounting screws. You could crack the porcelain grill coating.**

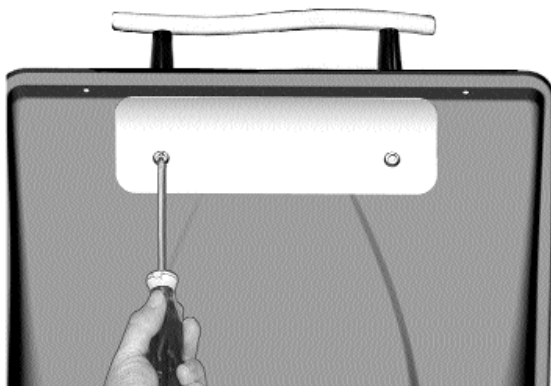

**TOOLS:**



**Item 19 Hood Shield 1 pc**

**Step 7 - Attach Flavor Activator™**

•Using the holes on each side of the Flavor Activator™(Item 16), place onto the two Flavor Activator™ mounting studs so that it lies above the burner.

**Item 16 Flavor Activator™ 1 pc**

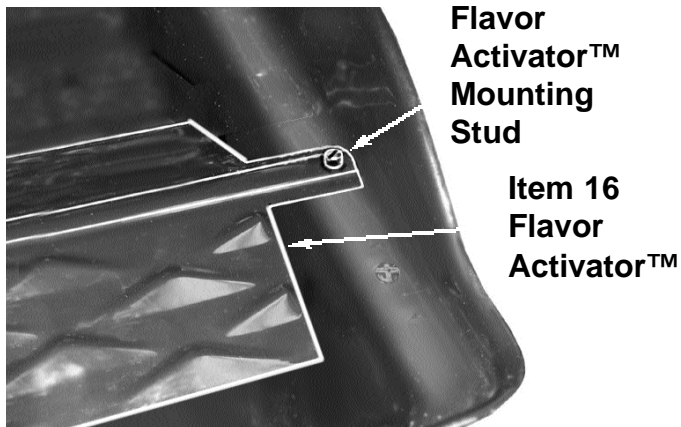
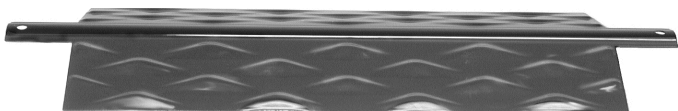

### Step 8 - Attach Privacy Panel

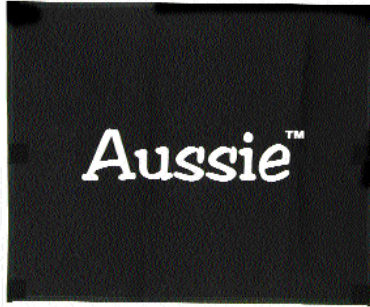

(ITEM 15 )  
PRIVACY PANEL  
1 pc

- Attach Privacy Panel to the velcro patches on back side of front legs as shown. Note: Privacy Panel may be removed to install LP Cylinder then reattached.



### Step 9 - Insert Cooking Grid



(ITEM 18)  
Porcelain Cooking Grid  
1pc

- Lay Cooking Grid into position above Flavor Activator™.



## **Step 10 - Attach LP Cylinder**

- Swing the Cylinder Retainer Clip to outside of the Bottom Shelf. Place the LP Cylinder in circular hole on Bottom Shelf. The cylinder should be turned slightly as shown below to allow the Regulator Hose to reach. Position Cylinder Retainer Clip over round shoulder of the LP Cylinder until it meets the cylinder carrying handle.
- Turn all control knobs and LP Cylinder valve to the "Off" position.
- Take the protective cap off the cylinder valve. Hold Regulator in a straight line with LP Cylinder valve so the connection does not cross thread. Insert nipple of regulator into the LP cylinder nozzle opening. Hand tighten coupling nut in clockwise direction. **Do not use tools.**

You are now ready to use your grill!

**Caution: When swinging Cylinder Retainer Clip into position, keep fingers and hands on corners of Clip to prevent Pinching.**

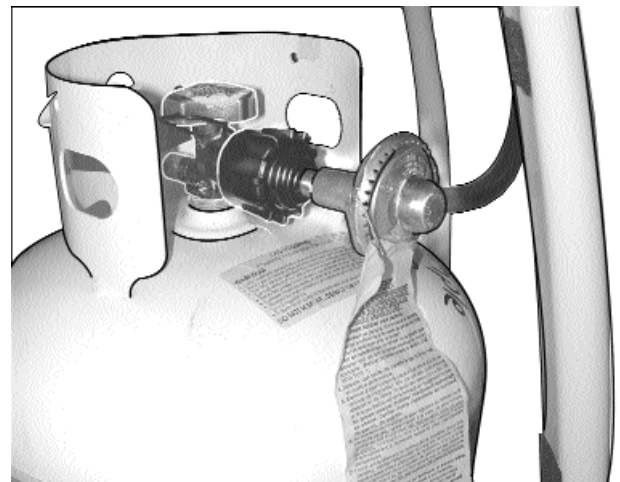
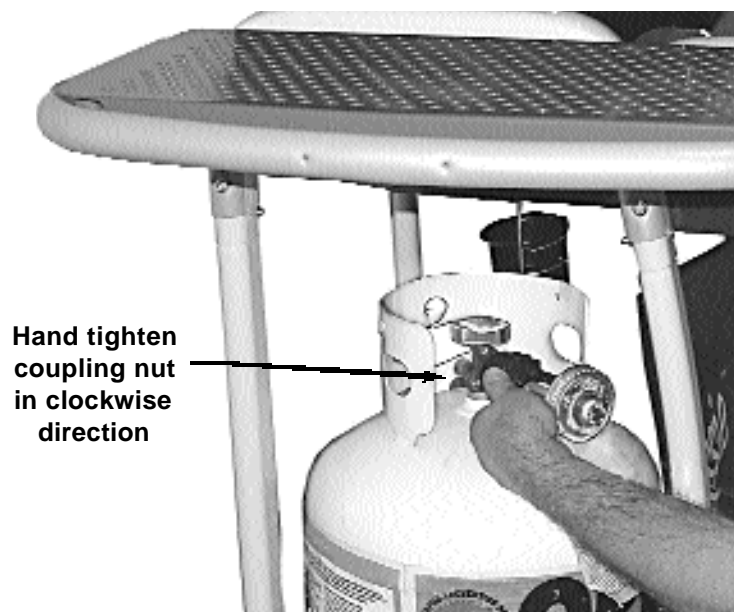
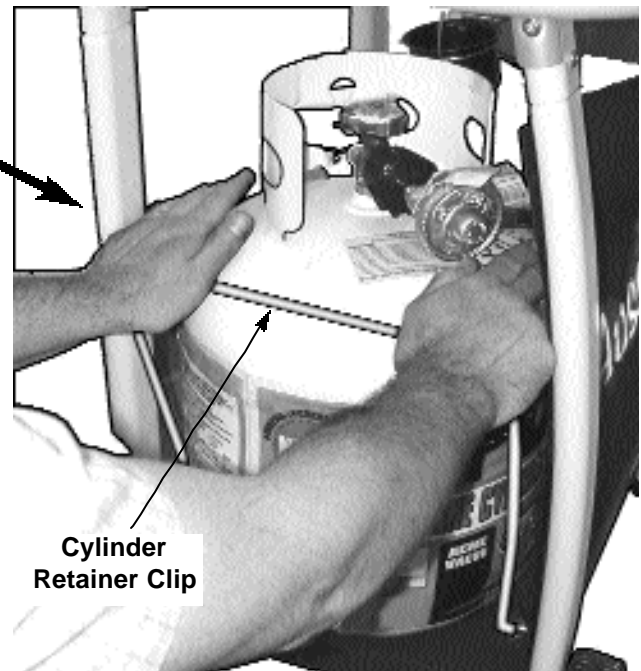

## Step 11 - Leak Test

•Before using your grill a leak test must be performed on the Control Valves, Burner manifold, and Regulator/ Hose connections.

### Supplies Needed for a Leak Test

Clean paint brush, water, and dishwashing liquid.

### How to perform a leak test

**WARNING! Never use an open flame to test for gas leaks.**

- 1) Use an LP Cylinder equipped with an OPD (Overfill Prevention Device) and have it filled at an authorized LP gas dealer by a qualified attendant.
- 2) Make sure all of the grill control panel knobs are turned to the "off" position and verify that the LP gas cylinder valve is closed by turning the knob on the LP gas cylinder clockwise until it stops.
- 3) Remove the protective cap from the LP cylinder gas nozzle.
- 4) Hold regulator in a straight line with LP cylinder gas nozzle so the connection does not cross thread.
- 5) Insert nipple of regulator into the LP cylinder nozzle opening.
- 6) Hand tighten coupling nut in a clockwise direction. Do not use tools.
- 7) Mix one cup of water with one cup of dishwashing liquid.
- 8) Open the valve on LP gas cylinder (Turn the knob on the LP gas cylinder counter-clockwise.)
- 9) Check for leaks by brushing the soap solution on all LP gas connections and fittings (such as those shown by the heavy arrows in the diagram below.) Make sure you generously brush the locations with the soap solution, completely surrounding the connections and fittings.
- 10) If "growing" bubbles appear on any of the connection points, then you have detected a gas leak. Immediately close the LP cylinder valve by turning the handle clockwise.
  - A) If leak appears at either end of hose and regulator assembly, retighten the connection at the leak, but do not overtighten. (Note: Only hand tighten at coupling nut) Repeat Leak Test.
  - B) If the leak is coming from the LP gas cylinder, from the valves at the control knobs, or if the leak cannot be stopped, do not use the grill. Call Customer Service at 1-800-251-7558.
- 11) Turn all control knobs to the "off" position and turn the handle on the LP gas cylinder clockwise until it stops. Disconnect LP gas cylinder by turning coupling nut on regulator in a counter-clockwise direction until regulator is released from threaded LP cylinder gas nozzle.
- 12) Place the protective cap over LP cylinder gas nozzle.

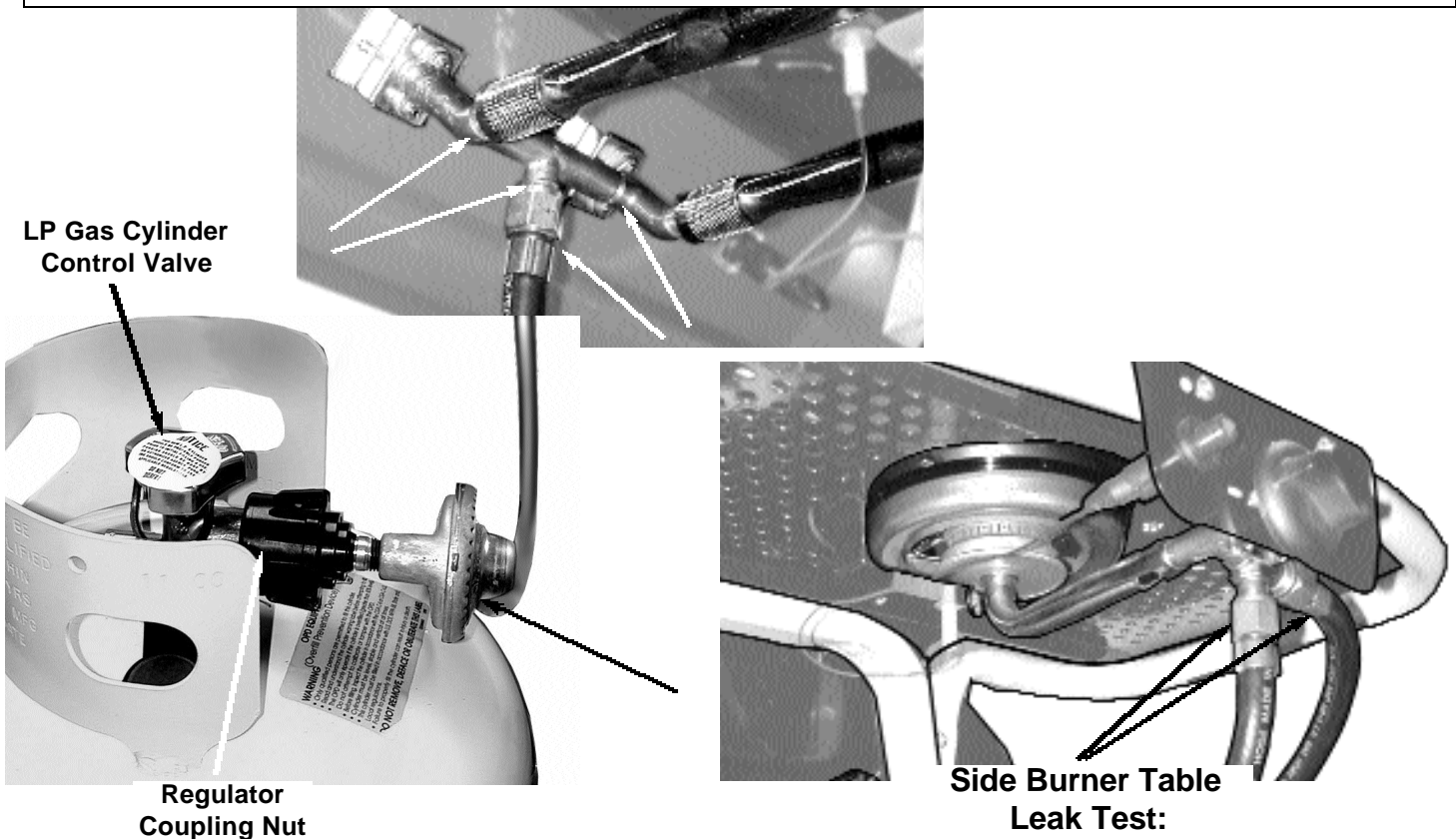

# OPERATING AND MAINTAINING YOUR GAS GRILL

## **GAS, CYLINDER, HOSE AND REGULATOR INFORMATION**

This LP gas grill was designed to use propane gas. Propane cylinders will supply gas all year round, even on cold winter days.

## **LP HOSE AND REGULATOR ASSEMBLY**

### **⚠ WARNING!**

• **Using a hose and regulator assembly that has not been supplied by the manufacturer of this LP gas grill, could result in serious bodily injury or property loss.**

- Use only the hose and regulator assembly that has been furnished with this LP gas grill. If the hose and regulator assembly is not working properly and you need a replacement, contact the manufacturer (1-800-251-7558).
- Inspect the hose before each use. If the hose is cut or damaged or shows signs of excessive abrasion or wear, do not use the LP gas grill. Contact the manufacturer, as the hose must be replaced with an assembly specified by the manufacturer prior to the further use of the LP gas grill.

## **LP Cylinder**

### **⚠ DANGER!**

- **Read and follow all warnings on LP gas cylinder.**
- **If you see, smell, or hear the hiss of LP gas escaping from the cylinder:**
  - 1) **Evacuate all people from the grilling area.**
  - 2) **Do not attempt to correct the problem yourself.**
  - 3) **Call the local fire department.**

- The LP gas cylinder, for use with the Aussie LP gas grills, must meet the following requirements:
  - 1) 12" diameter x 18" tall, 20 lb maximum capacity
  - 2) Overfill Protection Device (OPD) safety feature (should be noted on cylinder)
  - 3) Must be constructed and marked in accordance with the U.S. Department of Transportation (DOT) or the National Standard of Canada, CAN/CSA-B339. (See collar for marking)
  - 4) Must have collar to protect LP cylinder valve.
- Never use an LP gas cylinder if it shows signs of: dents, gouges, bulges, fire damage, corrosion, leakage, excessive rust or other forms of visual external damage; it may be hazardous and should be checked by a liquid propane supplier.
- The LP gas cylinder should never be filled more than 80% of cylinder volume. (20 lb. maximum) Do not ask the propane supplier to over-fill the cylinder.

- If you obtain LP gas through a cylinder exchange dealer, make sure you are getting a safe and adequate O.P.D. cylinder. Use only a licensed LP gas cylinder dealer.

- Keep children away from LP gas cylinder at all times.
- Do not use, store, or transport the LP gas cylinder where it would be exposed to high temperatures. The relief valve may open which will allow a large amount of flammable gas to escape. Never leave an LP gas cylinder inside a vehicle which may become overheated by the sun.

- **WARNING! Never store an LP cylinder indoors.** Storage of an outdoor cooking gas appliance indoors is permissible only if the cylinder is disconnected and removed from the outdoor cooking gas appliance. Cylinders must be stored outdoors out of the reach of children and must not be stored in a building, garage, or any other enclosed area.

- **WARNING! Never store a spare LP gas cylinder under or near the grill.** All spare and disconnected LP gas cylinders must have safety caps installed on the LP cylinder valve.

- LP gas is not natural gas. The conversion or attempted use of natural gas in an LP unit or LP gas in a natural gas unit is dangerous and will void your warranty.

- Never attempt to repair an LP gas cylinder valve yourself. See an authorized LP gas cylinder dealer for repairs.

- When transporting an LP gas cylinder, keep it secured in an upright position with cylinder valve turned to off position.

## **Connecting/ Disconnecting LP Gas Cylinder to Grill**

- Do not operate the LP gas grill when the LP gas cylinder is not attached to the cart as shown in the Assembly Instructions.

### **⚠ WARNING!**

- **Always check for gas leaks when you disconnect and reconnect the regulator to the LP gas cylinder, especially after a period of storage (for example, over winter).**
- **Check tubes that lead into the burner for any blockage from insects, spiders, or food grease before using.**
- **Check grill hoses for cracking, brittleness, holes, or leaks.**
- **Make sure there are no sharp bends in the hose or tubing.**
- **Make sure Regulator Hose does not contact hot metal surfaces.**

- Never connect or disconnect LP gas cylinder or fittings while grill is in use or is hot.
- When the LP gas cylinder is connected, the grill must be kept outside in a well-ventilated space. Turn off all of the grill control knobs and the LP cylinder valve when grill is not in use.
- Move gas hose as far away as possible from hot surfaces.

How to Connect your LP gas cylinder (See STEP 22 of Assembly Instructions for diagram)

- 1) Make sure all of the control knobs are turned to the “off” position and verify that the LP gas cylinder valve is closed by turning the handle on the LP gas cylinder valve clockwise until it stops.
- 2) Remove the protective cap from the LP cylinder gas nozzle.
- 3) Hold regulator in a straight line with LP cylinder gas nozzle so the connection does not cross thread.
- 4) Insert Regulator nipple into the LP cylinder nozzle opening.
- 5) Hand tighten coupling nut in a clockwise direction. Do not use tools.
- 6) Perform a Leak Test. (See STEP 10 of Assembly Instructions for Leak Test Instructions)

How to Disconnect your LP gas cylinder

- 1) Turn all control knobs to the “off” position and turn the handle on the LP gas cylinder clockwise until it stops.
- 2) Turn coupling nut on regulator in a counter-clockwise direction until regulator is released from threaded LP cylinder gas nozzle.
- 3) Place the protective cap over LP cylinder gas nozzle.

**BEFORE USING YOUR  
LP GAS GRILL**

**Selecting a Location**

**⚠ WARNING!**

- **Do not use an LP gas grill indoors, on recreational vehicles, or on a boat.**

- This LP gas grill is for outdoor use only and should be placed on firm, level surface. The grill should be setup in an open area with good ventilation, away from high traffic areas and combustible materials.
- Combustible or flammable materials should never be used or stored within 36 inches of the back or sides of your LP gas grill.
- Locate your LP gas grill at least 10 feet away from your house or any building. Do not use the grill in a garage, breezeway, carport, porch, or under a surface that can catch fire.

**Precautions**

**⚠ WARNING!**

- **Carefully read the Important Safeguards section of this manual (pages 2 through 4). Make sure you follow and understand all instructions and warnings. If you have any questions regarding these pages, call 1-800-251-7558 and ask for a Customer Service Representative.**

- This installation must conform with local codes or, in the absence of local codes, with either the National Fuel Gas Code, ANSI Z223.1, or CAN/CGA-B149.2, Propane Installation Code.
- If an external electrical source is utilized, the outdoor cooking appliance, when installed, must be electrically grounded in accordance with local codes or, in the absence of local codes, with the National Electrical Codes, ANSI/NFPA 70, or the Canadian Electrical Code, CSA C22.1.
- If any electric appliance or rotisserie is used with the LP gas grill, do not allow cords to touch or be near hot surfaces. Electric cords should be placed away from walkways to avoid a tripping hazard.
- Grill storage cover must be removed and placed at least 36 inches from the LP gas grill while in use. The grill cover is made of a flammable material. The grill must be completely cooled before putting the cover back on the grill.
- Never store a spare or disconnected LP gas cylinder under or near this LP gas grill.
- Inspect the hose and regulator assembly before each use. If the hose is cut or damaged or shows signs of excessive abrasion or wear, do not use the LP gas grill. Contact the manufacturer, as the hose must be replaced with an assembly specified by the manufacturer prior to the further use of the LP gas grill.
- Use only the hose and regulator assembly that is supplied with your LP gas grill.
- Use of this LP gas grill other than for the intended use, or alteration of the LP gas grill in any way may not be safe and will void any warranty.
- LP gas is not natural gas. The conversion or attempted use of natural gas in an LP unit is dangerous and will void your warranty.
- Never use an LP gas cylinder if it shows signs of: dents, gouges, bulges, fire damage, corrosion, leakage, excessive rust, or other forms of visual external damage; it may be hazardous and should be checked by a Liquefied Petroleum supplier. Do not use an LP cylinder with a damaged valve.
- Never use charcoal in your LP gas grill. Do not use aerosols or store flammable liquids or materials near this gas grill.

## Leak Testing

### **⚠ WARNING!**

- Always perform a leak test before each use.
- Leak test must be performed in a well ventilated area.
- Never perform a leak test on a grill while in use or hot.
- If you detect a gas leak that cannot be corrected by using the leak test procedures below, do not use the LP gas grill.
- Never smoke or have an open flame near the grill during a leak test.

#### **Supplies Needed for a Leak Test**

Clean paint brush, water, and dishwashing liquid.

**How to perform a leak test (See Step 10 of Assembly Instructions for leak test diagrams.)**

**⚠ WARNING! Never use an open flame to test for gas leaks.**

- 1) Use an LP Cylinder equipped with an OPD (Overfill Prevention Device) and have it filled at an authorized LP gas dealer by a qualified attendant.
- 2) Make sure all of the grill control panel knobs are turned to the "off" position and verify that the LP gas cylinder valve is closed by turning the knob on the LP gas cylinder clockwise until it stops.
- 3) Remove the protective cap from the LP cylinder gas nozzle.
- 4) Hold regulator in a straight line with LP cylinder gas nozzle so the connection does not cross thread.
- 5) Insert nipple of regulator into the LP cylinder nozzle opening.
- 6) Hand tighten coupling nut in a clockwise direction. Do not use tools.
- 7) Mix one cup of water with one cup of dishwashing liquid.
- 8) Open the valve on LP gas cylinder (Turn the knob on the LP gas cylinder counter-clockwise.)
- 9) Check for leaks by brushing the soap solution on all LP gas connections and fittings (such as those shown by the heavy arrows in the diagram below.) Make sure you generously brush the locations with the soap solution, completely surrounding the connections and fittings.
- 10) If "growing" bubbles appear on any of the connection points, then you have detected a gas leak. Immediately close the LP cylinder valve by turning the handle clockwise.
  - A) If leak appears at either end of hose and regulator assembly, retighten the connection at the leak, but do not overtighten. (Note: Only hand tighten at coupling nut) Repeat Leak Test.
  - B) If the leak is coming from the LP gas cylinder, from the valves at the control knobs, or if the leak cannot be stopped, do not use the grill. Call Customer Service at 1-800-251-7558.
- 11) Turn all control knobs to the "off" position and turn the handle on the LP gas cylinder clockwise until it stops. Disconnect LP gas cylinder by turning coupling nut on regulator in a counter-clockwise direction until regulator is released from threaded LP cylinder gas nozzle.
- 12) Place the protective cap over LP cylinder gas nozzle.

## OPERATING THE LP GAS GRILL

### **⚠ WARNING!**

- Before proceeding, make certain that you understand the Important Safeguards on pages 2 through 4 of this manual.
- Before lighting the LP gas grill, you must open the the hood to prevent an explosion from gas build-up.
- If your LP gas grill catches on fire:
  - If the fire is in the grill portion and you can safely reach the control knobs on the control panel, then turn them to the off position.
  - If the fire involves one of the hoses, and you can safely reach the LP cylinder valve, shut the valve off.
  - If the fire involves the cylinder, leave it alone, evacuate the area and call the fire department.
  - If there is any type of fire that threatens either personal safety or endangers property, call the fire department.
- If you notice grease or other hot material dripping from the grill onto the valve, hose, or regulator, turn off the gas supply immediately. After the grill has cooled, determine the cause and correct it. After cleaning the valve and hose and regulator assembly, perform a leak test before continuing use. (See Step 10 of Assembly Instructions)
- Do not operate an LP gas grill if you have knowledge of or suspect a gas leak.
- Never allow children to operate or play near an LP gas grill. Do not leave grill unattended.
- Always turn off the LP gas cylinder at the LP cylinder valve when not in use. Allow grill to cool before handling parts or cleaning.
- Do not move an LP gas grill when in use or hot.
- Never touch hot surfaces. Use heat resistant gloves, long-handled tongs, or cooking mitts at all times since the grill will become very hot. Open the hood carefully when cooking to avoid from the hot air and steam trapped inside.
- Do not wear loose clothing (example: hanging shirt tails, clothing with frills, etc.) around a LP gas grill while in use or hot.
- Never lean your body over the LP gas grill when lighting it or while it is in use or hot.
- This LP gas grill is not designed to be used with a solid plate (griddle.) Full coverage of plates will cause excessive heat and could damage the grill.



## Preparation Before Cooking

- Wash the porcelain or chrome coated Cooking Grids with a mixture of hot water and baking soda.
- Empty the grease cup after each cooking session so excessive grease does not accumulate.

**Failure to remove grease may result in grease dripping onto the cart and/or a grease fire in the tray.**

## Lighting the Grill Using Igniter

### **⚠ WARNING!**

- Open Hood before lighting the grill to prevent an explosion from gas buildup.
- Always inspect the gas hose and regulator assembly before each use. If the hose is cut, damaged, or shows signs of excessive abrasion or wear, do not use the LP gas grill. Contact the manufacturer, as the hose and regulator assembly must be replaced with an assembly specified by the manufacturer prior to further use of the LP gas grill.

How to light your LP gas grill (See diagram below for illustrations)

- 1) Open Hood
- 2) Important: Make sure control knobs are turned "off" first. Open the LP gas cylinder valve by turning the valve handle counter-clockwise until it stops.

1. Open Hood



4. Push in the Igniter several times to light.

- 3) From the "Off" position, push control knob in on the left side and turn counter-clockwise to the high position.
- 4) Push the igniter button several times so that it clicks each time.
- 5) Check to make sure that the burner is lit.
- 6) Light the remaining half of the burner by turning the control knob counter-clockwise. Your grill has a crossover ignition system that allows the burner to light each side successively.
- 7) If burners does not light, repeat Step 3. The burner should light within three or four attempts. If burner still does not light, try the right side.

**⚠ WARNING: If both sides of the burner fail to light after following Steps 3 & 4, turn all knobs to the "off" position and close the valve on the LP gas cylinder. Wait five minutes; then repeat all of the above lighting procedures.**

**Note:** If the burner still fails to light, refer to the [Troubleshooting](#) page. The burner can be lit manually, see [Manual Lighting of the Grill](#).

- 8) After ignition, preheat the grill by turning the control knobs to "High" for 3-5 minutes. The grill should be pre-heated before every cooking session. The hood should be closed during preheating.

**⚠ WARNING: If a burner goes out during the cooking cycle, turn all knobs to the off position and close the valve on the LP cylinder. Open hood and wait five minutes before attempting to relight the grill.**

2. Turn LP cylinder handle counter-clockwise to open.



3. Push in left or right control knob and turn counter-clockwise to the "High" position.

## Lighting the Side Burner (Elite Series Only)

How to light your LP Gas Grill Side Burner (See diagram below for illustrations)

- 1) Important: Make sure Side Burner Control Knob is turned "off" first. Make sure the LP gas cylinder valve is open by turning the valve handle counter-clockwise until it stops.
- 2) From the "Off" position, push in the Side Burner Control Knob (right most knob of the control panel) and turn counter-clockwise to the "high" position.
- 3) Push the igniter button several times so that it clicks each time.
- 4) Check to make sure that the burner is lit.
- 5) If the side burner does not light, repeat Steps 2 and 3. The burner should light within three or four attempts.

**WARNING:** If burner fails to light after following Steps 2 & 3, turn Side Burner Knob to the "off" position and close the valve on the LP gas cylinder. Wait five minutes; then repeat all of the above lighting procedures.

**Note:** If the burner still fails to light, refer to the [Troubleshooting](#) page.



**1. Make sure Side Burner Control Knob is turned "off" first. Make sure the LP Gas Cylinder valve is open by turning the valve counter-clockwise until it stops.**

**2. Push the Side Burner Control Knob and turn counter-clockwise to the high position.**

**3. Push igniter button to light.**

LP Gas Cylinder Valve

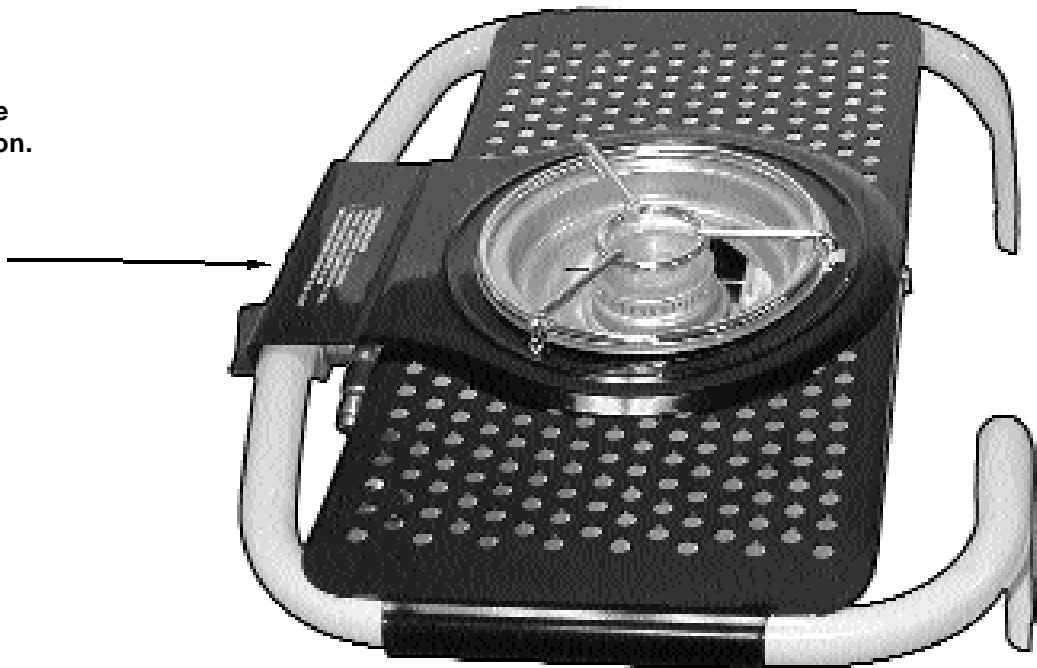
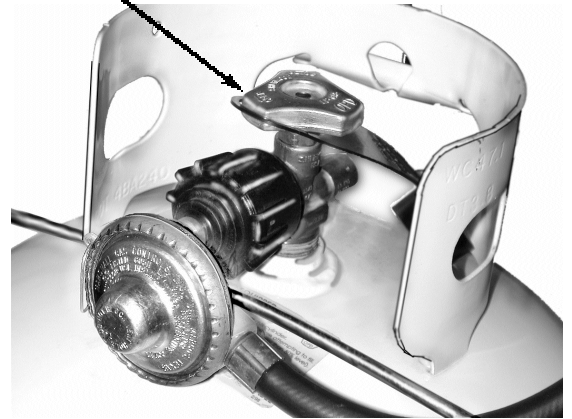

## Manual Lighting of the Grill

### **⚠ WARNING!**

- Open Hood before lighting the grill to prevent an explosion from gas build-up.
- Always inspect the gas hose and regulator assembly before each use. If the hose is cut, damaged, or showing signs of excessive abrasion or wear, do not use the LP gas grill. Contact the manufacturer, as the hose must be replaced with an assembly specified by the manufacturer prior to further use of the LP gas grill.

### How to manually light your LP gas grill

- 1) Open Hood
- 2) Important: Make sure Control Knobs are turned "off." Open the LP gas cylinder valve by turning counter-clockwise until it stops.
- 3) Insert a lit match through match-lighting hole underneath the grill bowl on the right side. (See figure below).

1. Open hood

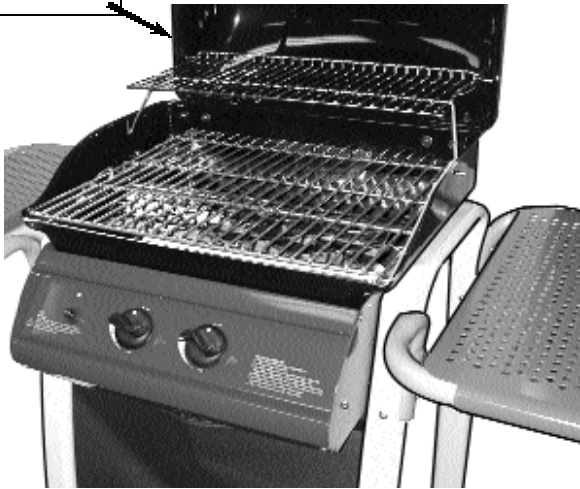

3. Match lighting hole in right side of grill body - Insert a lit match through the match lighting hole.

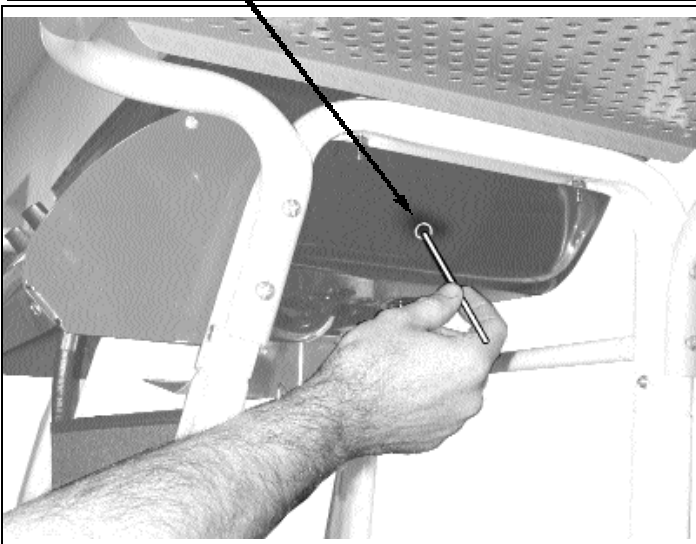

- 4) Push in and turn the right main burner control knob counter-clockwise to the "high" position.

**⚠ WARNING:** If the burner fails to ignite after following the above procedure, turn control knob to the off position and close the valve on the LP cylinder. Wait five minutes and repeat all of the above manual lighting procedures. If the grill still fails to light, see the [Troubleshooting](#) page.

- 5) Check to make sure that the burner is lit.
- 6) Light the remaining half of the burner by turning the control knob counter-clockwise. Your grill has a crossover ignition system that allows the burner to light each side successively.
- 7) If burner does not light, repeat Step 3. The burner should light within three or four attempts.
- 8) After ignition, preheat the grill by turning the control knobs to "High" for 3-5 minutes. The grill should be pre-heated before every cooking session. The hood should be closed during preheating.

**⚠ WARNING:** If the burner goes out during the cooking cycle, turn the control knob to the "off" position and close the valve on the LP cylinder. Wait five minutes before attempting to relight.

2. Turn LP cylinder handle counter-clockwise until it stops.

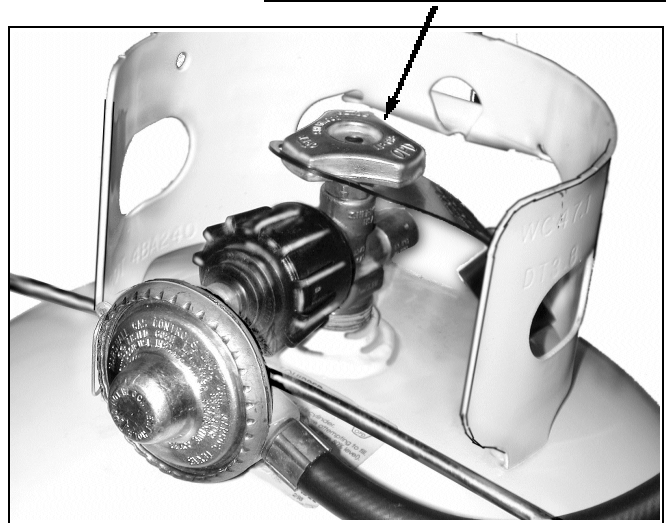

4. Push in right control knob and turn counter-clockwise to the "High" position.



## Check Your Flame

Your burner has been preset by the manufacturer for optimal flame performance. A blue flame, possibly with a small yellow tip, is the result of the optimal air and LP gas mixture. (See diagram below)

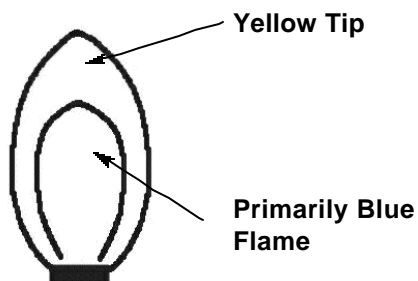

The flame should be checked before the initial cooking session and periodically throughout the grilling season, especially after storing the grill over a long period of time. If the flame is significantly yellow in color, then you are not getting the appropriate amount of LP gas in the air /LP gas mixture. This could be a result of a blocked burner from grease drippings or from insects building a nest inside the burner or burner opening. You should follow the Burner Maintenance section of this manual for cleaning the burners.

## Grill Cooking

The burner heats up the Flavor Activator™ underneath the grid, which in turn heats the food on the grill. The natural food juices produced during cooking fall onto the hot Flavor Activator™ below and vaporize. The subsequent rising smoke bastes the food, as it travels upwards, giving it that unique barbecued flavor.

## Roasting Hood Cooking

The grill is equipped with a roasting hood giving the option of cooking with hood closed to form an 'oven' for roasting food, such as roasts of meat, whole chickens, etc. When the hood is closed, a large amount of heat is trapped inside the grill. Thus, it is IMPORTANT to make sure that the burner is turned to the low position to prevent burning of the food. Avoid lifting the hood unnecessarily as heat is lost every time the hood is opened.

## End of Cooking Session

### **⚠ WARNING!**

- **Never leave your LP gas grill unattended during use or cleaning.**

After each cooking session, close the hood and turn the grill burners to the "high" position and burn for five minutes. This procedure will burn off cooking residue, thus making cleaning easier.

## Turn off Your LP Gas Grill

### How to turn off your LP gas grill

- 1) When you have finished using your grill, turn the grill Control Knobs clockwise to the "Off" position.
- 2) Turn off the gas at the LP cylinder valve by turning the handle clockwise until it stops.
- 3) Wait until the grill is cool before closing the grill hood and putting on the cover.

**⚠ WARNING! Never store an LP gas cylinder indoors (empty or filled). If storing the gas grill indoors, disconnect LP gas cylinder and store it outdoors out of the reach of children.**

## CARE AND MAINTENANCE

### **⚠ WARNING!**

- **Always turn "off" the LP gas cylinder at the LP cylinder valve, when not in use. Allow the grill to cool before handling parts or cleaning.**
- **Do not move an LP gas grill when in use or hot.**
- **Never touch hot surfaces. Use heat resistant gloves, long-handled tongs, or cooking mitts at all times since grill will become very hot.**
- **Do not wear loose clothing (for example: hanging shirt tails, clothing with frills, etc.) around a LP gas grill while in use or hot.**
- **Never lean your body over the LP gas grill when lighting it or while it is in use or hot.**
- **Never douse the grill with water when its surfaces are hot because it may cause grease to splatter or the porcelain cooking grids and hood to break.**

## CARE AND MAINTENANCE

Regularly clean your LP gas grill between uses and especially after extended periods of storage. Ensure the grill and its components are cool before cleaning. In order to extend the life and maintain the condition of your grill, we strongly recommend that the unit be covered when stored outside for any length of time, especially during the winter months.

### Porcelain coated Cooking Surfaces (Deluxe & Elite Series Only)

Most residue on the Cooking Grids can be cleaned with a baking soda and water solution. For stubborn stains, use a nonabrasive scouring powder. Do not use steel wool or other like cleaning products on the porcelain coated surfaces. This will scratch the porcelain coating causing foods to stick.

## Burner Maintenance

### **⚠ WARNING!**

- Check the LP gas grill for gas leaks and Burner obstructions before each use.
- Always turn off the LP gas cylinder at the LP cylinder valve when not in use. Allow grill to cool before handling parts or cleaning.

Provided that the Burner is operating correctly, in normal usage, burning off the residue after cooking will keep the burner clean. The Burner should be removed and cleaned annually, or whenever heavy build-up is found, to ensure that there are no signs of blockage (debris, insects) in either the burner portholes, the primary air inlet, or the neck of the burner. (See Burner cleaning instructions below)

### How to clean the Burner

- 1) Make sure the LP cylinder and grill control knobs are turned off, and the grill has completely cooled.
- 2) Carefully remove Grease Cup, Cooking Grid, and Flavor Activator™.
- 3) Remove the Burner, by first removing the Heat Shield from the bottom of grill Bowl. Remove the two screws securing the burner (also located underneath the grill bowl.)
- 4) Remove Burner from the grill.
- 5) Use a pipe cleaner to clear obstructions from the Burner holes and inlet hole. Verify that there are no insects or insect nests blocking the inlet hole. Normal wear and corrosion may enlarge some holes, however, if large cracks or holes are found the Burner should be replaced. **Note: It is normal for surface rust to be present on the Burner.**
- 6) If grill is to be stored, coat Burner lightly with cooking oil. and Wrap in a protective cover to keep insects out.
- 7) After cleaning, reinstall Burner and other parts removed back into grill. Note: When refitting the Burner, be careful to check that it is positioned correctly. (Refer to Step 6 of Assembly Instructions for reinstallation)

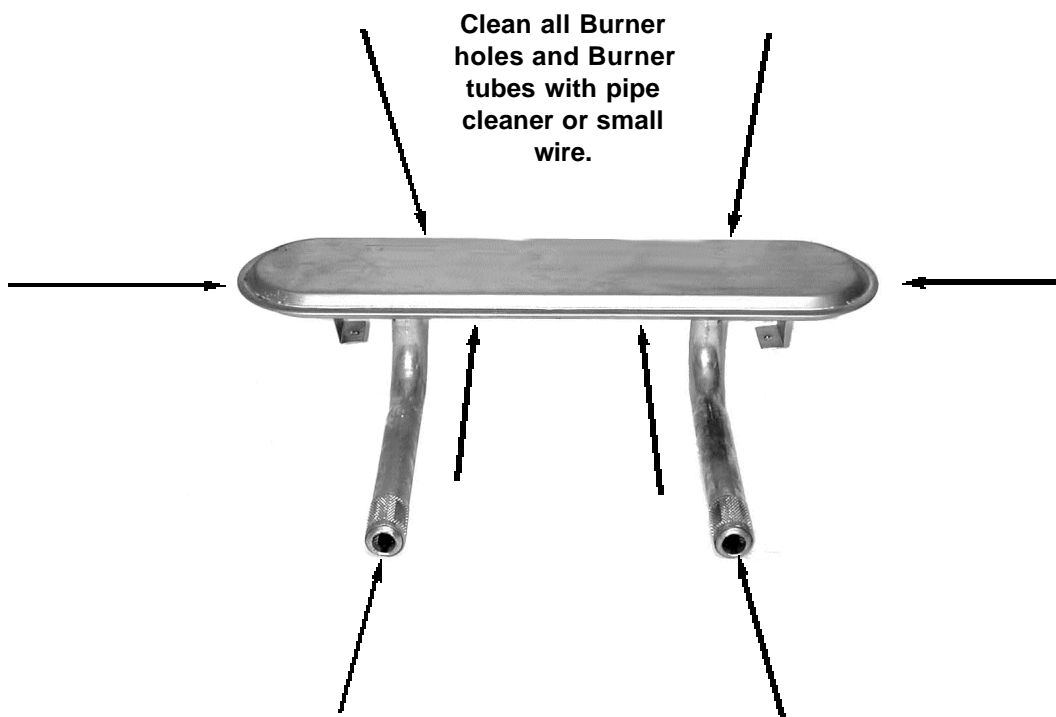

## Flavor Activator™

Remove and wash the Flavor Activator™ in order to keep it clean. Burning off the residue after each cooking will make cleaning easier. Clean with soap and water.

## Drip Cup

### ⚠ WARNING!

- Always turn the LP gas cylinder valve “Off” when not in use. Allow grill to cool before handling parts or cleaning.
- Empty the Grease cup after each cooking session so excessive grease does not accumulate. Failure to remove grease may result in grease dripping onto the cart and/or a grease fire in the cup.
- Never light the LP gas grill without the grease cup in place.

- Before each use, remove all grease from your Grease Cup.
- Make sure Grease Cup is in place before each grilling session.
- Failure to remove grease from the Grease Cup may result in grease dripping onto the cart.

## Cleaning the Grill Bowl

### ⚠ WARNING!

- Always turn off the LP gas cylinder at the LP cylinder valve when not in use. Allow grill to cool before handling parts or cleaning.

### How to Clean the Grill Body

- 1) Remove Cooking Grid, Flavor Activator™, and Burner before full cleaning.
- 2) Remove excess grease and/or fat from the grill Bowl with a soft plastic or wooden scraper. Never use steel wool or other abrasive cleaning product on porcelain coated surfaces.
- 3) For further cleaning, use hot soapy water and a cloth, or nylon-bristled brush only. **Do not immerse the gas controls or manifold in water. Make sure all water is removed from Burner.**
- 4) When finished cleaning, replace Burner, Flavor Activator™ and Cooking Grid.
- 5) Check burner operation after reassembly.

### ⚠ WARNING!

- Always turn off the LP gas cylinder at the LP cylinder valve when not in use. Allow grill to cool before handling parts or cleaning.
- Do not use aerosols or store flammable liquids or materials near this gas grill.

## Preventive Maintenance

Periodically check and tighten all nuts, bolts, and screws.

## Storage

### ⚠ WARNING!

- Never store an LP gas cylinder indoors (empty or filled). If storing the gas grill indoors, disconnect the LP gas cylinder and store it outdoors out of the reach of children.
- Never leave an LP gas cylinder inside a vehicle which may become overheated by the sun.
- Never store a spare or disconnected LP gas cylinder under or near the LP gas grill.
- Always turn off the gas cylinder when not in use. Allow grill to cool before handling parts or cleaning.
- Even though your LP gas cylinder may appear to be empty, gas may still be present and the cylinder should be transported and stored accordingly.

- Store your LP gas grill in a cool dry place .
- Disconnect LP gas cylinder from grill and store outside, in a dry, well-ventilated area, away from any sources of heat or ignition. Re-cap LP cylinder valve with the Safety Cap.
- Remove Burner and wrap with aluminum foil to prevent insects from entering the burner holes. Store wrapped Burner on top of cooking grid.
- Before next use, remove aluminum foil and reinstall Burner, Flavor Activator, and Cooking Grid.
- Check your LP gas grill for gas leaks, deterioration, proper assembly, and burner obstructions before using the grill after periods of storage and/or non-use(i.e. over winter).

# TROUBLESHOOTING

<u>Problem</u>	<u>Possible Cause</u>	<u>Solution</u>
<b>Burner will not light using the ignitor</b>	Burner is not connected to Valve.	Insure BurnerTube is on the end of Valve
	Not pausing long enough before clicking the Igniter Button	When lighting the Burner, push-in and turn control panel knob counter-clockwise to the high position. Pause 4 seconds, then push in Igniter button several times so that it clicks each time.
	No spark	Gas collector tab is bent (making too large or small of a gap between electrode and tab). By hand, bend gas collector tab back within a maximum of 3/16" gap to electrode. Make Certain gas Collector and Igniter are tight.
	LP gas cylinder is empty	Take LP gas cylinder to licensed LP gas supplier to be refilled
	Coupling nut is not fully connected to regulator	Tighten coupling nut by hand about one-half to three quarters additional turn. Do not use tools.
	Excess flow valve tripped in regulator	Turn control knobs to "off" position and turn LP gas cylinder handle clockwise until it stops. Wait five minutes. Relight LP gas grill. If flame remains to be low, turn off gas at cylinder and grill. Disconnect the regulator from the LP gas cylinder. Reconnect the regulator to the LP gas cylinder. Perform a leak test. Relight grill. This will reset the excess flow valve.
	Obstructions in burner	Clean burner (See Burner Maintenance in Care and Maintenance section of this manual)
	Electrode and burner are wet	Dry electrode with clean cloth
	Wire is loose or disconnected	Reconnect the wire
	Wire is shorting (sparking between ignitor wire and electrode)	Replace ignitor wire/electrode assembly (Call the Customer Service Department)
<b>Burner will not light using a match</b>	Burner is not connected to Valve.	Insure BurnerTube is on the end of Valve.
	LP gas cylinder is empty	Take LP gas cylinder to licensed LP gas supplier to be refilled
	Excess flow valve tripped in regulator	Turn control knobs to "off" position and turn LP gas cylinder handle clockwise until it stops. Wait five minutes. Relight LP gas grill.
	Coupling nut is not fully connected to regulator	Tighten coupling nut by hand about one-half to three quarters additional turn. Do not use tools.
	Obstructions in burner	Clean burner (See <u>Burner Maintenance</u> in <u>Care and Maintenance</u> section of this manual)

# TROUBLESHOOTING

<u>Problem</u>	<u>Possible Cause</u>	<u>Solution</u>
<b>Flames blow out</b>	High or gusting winds	Turn front of grill to face wind or increase flame height.
	Gas in LP cylinder is low	Check LP gas cylinder. Refill if necessary.
	Excess flow valve tripped	See "Low flame" problem above
<b>Flare up</b>	Grease build up	Clean grill
	Excessive fat in meat	Trim fat from meat before grilling
<b>Persistent grease fire</b>	Grease trapped around burner system	Turn control knobs "off" and turn handle of LP cylinder clockwise until it stops. Open hood carefully and let fire burn out. After the grill cools, remove and clean all parts.
<b>Unable to fill LP tank</b>	Some dealers have older fill nozzles with worn threads.	The worn nozzles don't have enough "bite" to engage the valve. Try another licensed LP dealer.
<b>Humming or whistling from the regulator</b>	Outside temperature, humidity, barometric pressure, and the gas level within the tank may cause the rubber diaphragm inside the regulator to vibrate, making a humming or whistling sound.	Although this sound may be alarming, this is NOT dangerous as long as it is not accompanied by the smell of gas. Simply adjust the burner settings and usually the sound will subside. If the humming sound persists, a change in atmospheric conditions will eventually stop the vibration. Should you smell gas, do not use the grill and call Customer Service at 1-800-251-7558
<b>Low flame or low heat</b>	Gas in LP cylinder is low	Check LP gas cylinder. Refill if necessary.
	Excess flow valve tripped in regulator	Turn control knobs to "off" position and turn LP gas cylinder handle clockwise until it stops. Wait five minutes. Relight LP gas grill. If flame remains to be low, turn off gas at cylinder and grill. Disconnect the regulator from the LP gas cylinder. Reconnect the regulator to the LP gas cylinder. Perform a leak test. Relight grill. This will reset the excess flow valve.

**If your problem is not resolved from the information provided above, please call Customer Service at 1-800-251-7558.**



# IMPORTANT NOTICE

The gas grill is setup to operate with a LP Gas Cylinder equipped with an OPD (Overfill Prevention Device).

This is a secondary device to prevent the overfill of your LP Gas cylinder. The proper methods for the filling of your LP Gas cylinder are by weight or volume, as described in NFPA 58. Please make sure your filling station fills your LP Gas cylinder by weight or volume. Ask your filling station to read purging and filling instructions on the LP cylinder before attempting to fill.

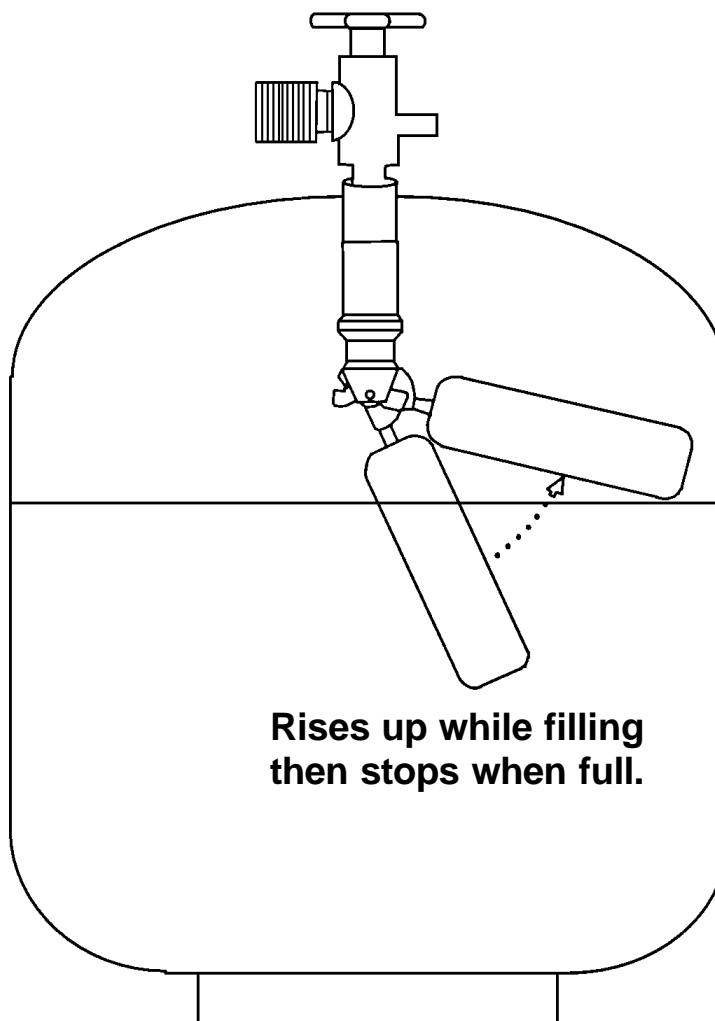

**⚠ WARNING!** Do not exchange the LP Gas cylinder unless the exchange LP cylinder is equipped with an OPD. Otherwise you will lose the OPD (Overfill Prevention Device) feature. If there is not an LP cylinder available for exchange equipped with an OPD, we recommend that you have your cylinder filled at an authorized LP gas dealer by a qualified attendant.

AUSSIE GRILL COMPANY  
LIMITED WARRANTY

This product is warranted to the original consumer purchaser against defects in material and workmanship under normal outdoor household use and correct assembly (if assembled by the consumer-purchaser). Burner and Cooking Grid are warranted for a period of one (1) year from the date of purchase. All other parts are warranted for a period of one (1) year from the date of purchase. Aussie Grill Company DOES NOT warrant in any way the propane cylinder (see label on cylinder for cylinder manufacturer's warranty.) The LP cylinder manufacturer is responsible for the materials, workmanship and performance of the cylinder. If the cylinder has a defect, malfunctions, or you have a question regarding the cylinder, call the cylinder manufacturer's customer service center. The phone number is on the cylinder. If the cylinder manufacturer has not resolved the issue to your satisfaction, then call Aussie Grill Company at the customer service number listed below.

Aussie Grill Company may require reasonable proof of purchase and we suggest you keep your receipt. Damages caused by commercial or institutional use, accidental or intentional damage, repairs made or attempted by unauthorized persons, or misuse are not covered by this warranty. If defective, the part or product will be repaired or replaced at the option of Aussie Grill Company without charge.

This warranty does not include the cost of any inconvenience or property damage due to failure of the product and does not cover damage due to misuse, abuse, accident, damage arising out of transportation of the product, damage incurred through commercial use, or failure to perform normal and routine maintenance. LIABILITY FOR CONSEQUENTIAL PROPERTY OR COMMERCIAL DAMAGES ARE EXPRESSLY EXCLUDED BY THIS WARRANTY. ANY APPLICABLE IMPLIED WARRANTIES OF MERCHANTABILITY AND FITNESS ARE LIMITED IN DURATION TO THE PERIOD COVERAGE OF THIS EXPRESS WRITTEN LIMITED WARRANTY. Some states do not allow limitation on how long an implied warranty lasts, so this limitation may not apply to you.

Deterioration or damage due to severe weather conditions such as hail, hurricanes, earthquakes or tornados, discoloration due to exposure to chemicals either directly or in the atmosphere, is not covered by this limited warranty.

No returns will be accepted without prior authorization from Aussie Grill Company. Authorization for return may be obtained by calling 1-800-251-7558. Handling and transportation costs for returning the product are not covered by this warranty and will be paid for by the purchaser. Please send your correspondence to:

Aussie Grill Company  
1500 Industrial Road  
Greeneville, TN 37745

For reference and correspondence,  
record your Serial number here.  
(See nameplate on side of grill.)

Serial No. \_\_\_\_\_  
Please use this number in registering  
your warranty and any correspondence  
with Aussie Grill Company.

P/N 03.4139.00  
REV. 6/2003